



tempio[®] BAGUETTE

SUNSCREEN SYSTEMS | SISTEMA DE LAMAS CERÁMICAS

TERRACOTTA & GLAZED SUNSCREENS

PAREDES DE BAGUETE

tempio®



Solar shading
Protección solar

Horizontal and vertical element orientation
Orientación horizontal y vertical

Suitable for any building size
Apto para cualquier tamaño del edificio

Venetian blind slats with Ceramics
Celosía con lamas de Cerámica

Window sill and wall copings
Alfeizares de ventanas y coronación de paredes

Profiles with hollow chambers
Perfiles con cámaras huecas

Customized designed substructure
Subestructura especialmente diseñada

Wide variety of terracotta colours and glazed colours with gloss or matt finish. On request, other finishing colors can be produced.

Gran variedad de colores naturales y esmaltados brillo o mate. También fabricamos colores bajo demanda.

Customized pieces
Piezas a medida

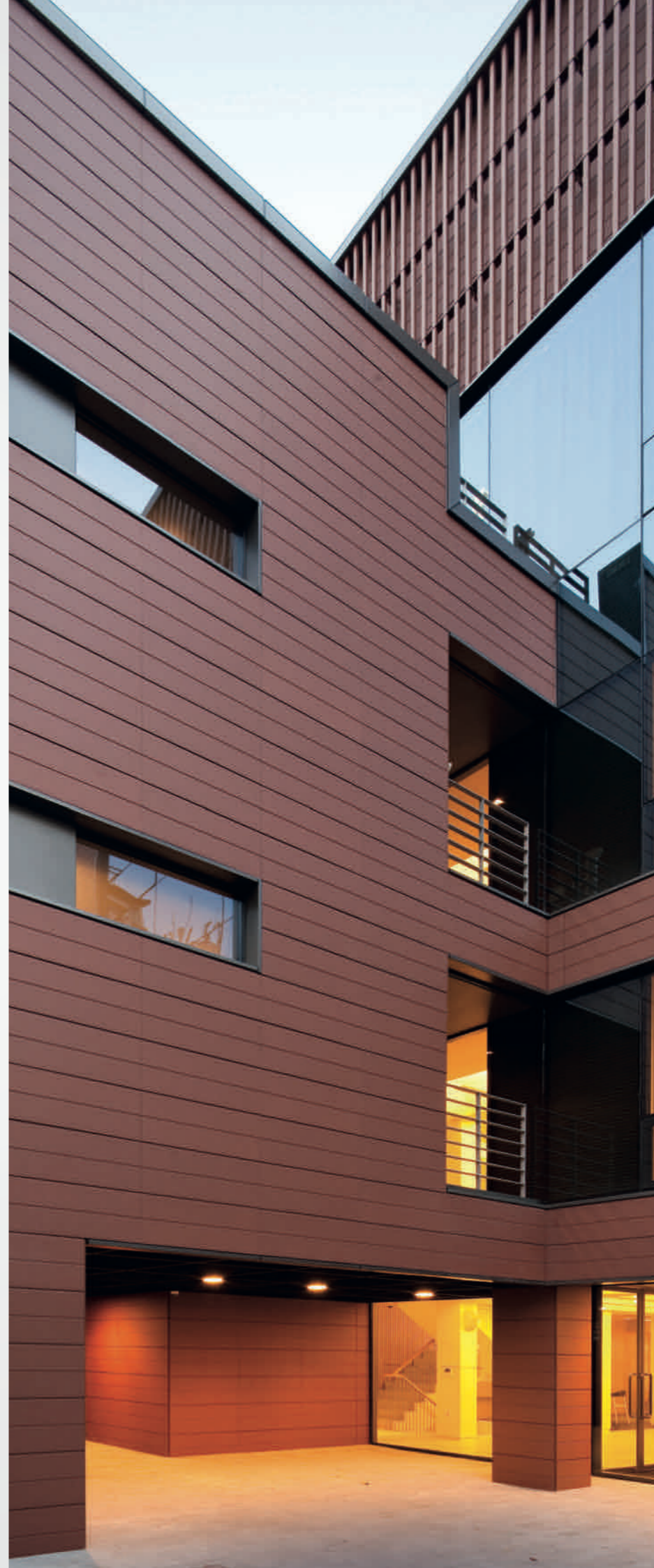

Advantages for façade in safety, comfort and aesthetics

Ventajas para fachada en seguridad confort y estética

EXCELLENT ISOLATION PROTECCIÓN AISLANTE

- Energetic costs 25-40% reduction**
_ Reducción entre 25-40% del gasto energético
- Increased thermal and acoustic comfort**
_ Aumento del confort térmico y acústico
- No water condensation**
_ Eliminación del agua de condensación
- Waterproof building**
_ Impermeabilidad del edificio
- Passive ventilation**
_ Ventilación pasiva
- Thermal isolation**
_ Aislante térmico
- Double wall**
_ Doble pared

SUSTAINABLE SOSTENIBLE

- 0% wastewater discharged**
_ 0% de aguas residuales vertidas
- Low CO2 emissions**
_ Mínima emisión de CO₂
- Waste material recycling**
_ Reciclaje del material sobrante

LONG LIFE PRODUCT PRODUCTO DE LARGA VIDA

- Unalterable colours**
_ Colores inalterables al paso del tiempo
- Self-cleaning with rainwater**
_ Autolimpiable con agua de lluvia
- Time resistant**
_ Resistente al paso del tiempo

REHABILITATION REHABILITACIÓN

- Direct application without creating debris**
_ Aplicación directa sin crear escombros
- Piece by piece replaceable system**
_ Sistema reemplazable pieza por pieza
- Revaluation of property**
_ Revalorización del inmueble
- Hidden conductions**
_ Paso de conducciones no vistas
- Hidden cracks and crevices**
_ Grietas ocultas

PROJECT
Abercrombie Building
University of Sydney Business School

LOCATION
Darlington, Australia

ARCHITECT
Woods Bagot/Kann Finch

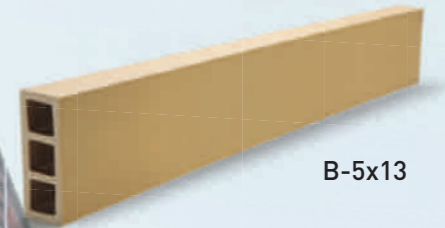

CONTRACTOR
John Holland

PIECES



B-5x13

COLOURS

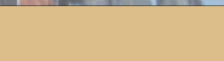
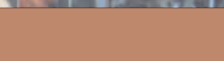
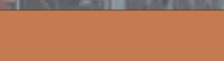
-  White Formentera EB3210
-  Blanco W2-07
-  Amarillo Y125-15
-  Rojo R05-05
-  Rojo R25-25



PROJECT
Biological Science Building
University Of New South Wales (UNSW)

LOCATION
Sydney, Australia

ARCHITECT
Woods Bagot, John Norman

CONTRACTOR
Sharvain Projects

PIECES



FK-20



B-5x5
B-250x60

COLOURS

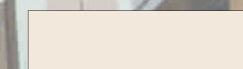

Blanco W00-20

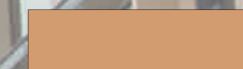

Naranja NA05-05

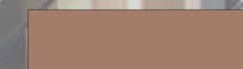

Rojo R15-10

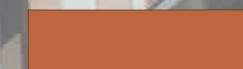

Rojo R25-19

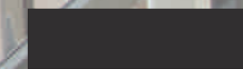

Negro B5-10



PROJECT
UNSW University of new South Sales Sydney

LOCATION
FJMT Sydney (Mathew Todd & Janine Deshon)

ARCHITECT
Installation Company Yuanda
Construction Company Brookfield Multiplex

CONTRACTOR
John Holland

PIECES



COLOURS



PROJECT
Kuntola School

LOCATION
Järvenpää, Finland

ARCHITECT
Kirsti Sivén & Asko Takala

PIECES



FS-20



B-5x13

COLOURS

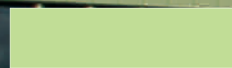

Green Exeter EB3415

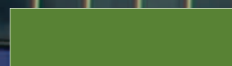

Green Glasgow EB3470



Violet Medellin EB3980



Blue Mediterraneo EB3360



PROJECT
Doosan Leadership Institute

LOCATION
Seoul, South Korea

ARCHITECT
Park Gene, AI Architects

CONTRACTOR
Sunpark

PIECES



FK-L1/16-400



B-5x13

COLOURS



Marrón BR2-08



Ceramic blind slats on façade
Celosía con lamas de Cerámica



B-d50



B-5x5 curvo



BO-160x50

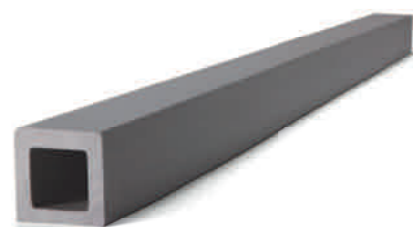

B-5x5

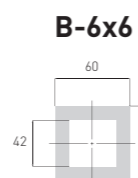
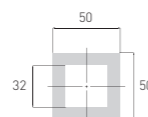

B-6x6

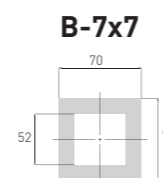

B-7x7

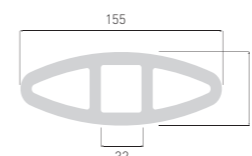

BO-200x50

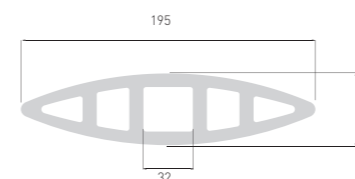

B-5x8 r50

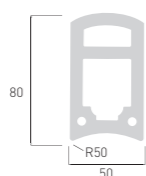

B-5x8

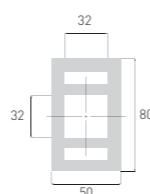

BO-300x62

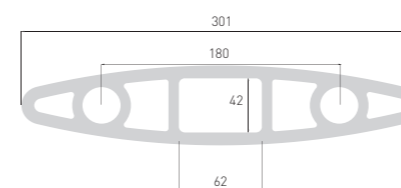

B-5x13

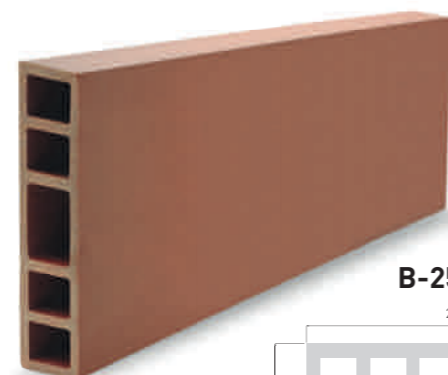
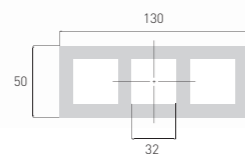

B-250x60

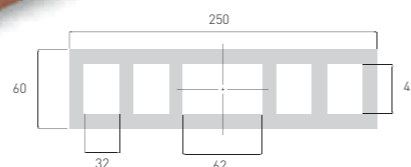

Size guide
Guía de medidas

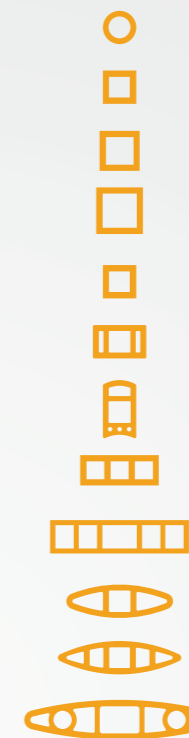

piece / pieza	length piece / largo pieza	weight / peso / kg/m lineal
B-d50	< 1800 mm	2,5
B-5x5	< 1800 mm	3,5
B-6x6	< 1800 mm	4
B-7x7	< 1800 mm	5
B-5x5 curve	< 1800 mm	3,5
B-5x8	< 1800 mm	5,5
B-5x8 r50	< 1800 mm	5,5
B-5x13	< 1800 mm	7,7
B-250x60	< 1800 mm	15
BO-160x50	< 1500 mm	7,6
BO-200x50	< 1500 mm	9,7
BO-300x62	< 1500 mm	17,5

Profiles with hollow chambers
Perfiles con cámaras huecas

Specially designed substructure
Subestructura especialmente diseñada

Special projects
Proyectos especiales

Made-to-measure on request
Fabricación a medida bajo demanda

Special Cuts
Cortes especiales

Colour development for projects
Desarrollo de colores especiales para proyectos



Ceramic oval blind slats on façade
Celosía con lamas ovales de Cerámica



BO-160x50

BO-200x50

BO-300x62

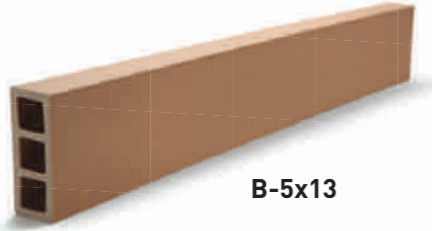

B-5x13

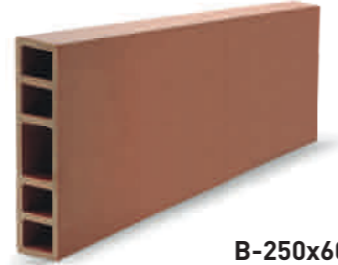

B-250x60

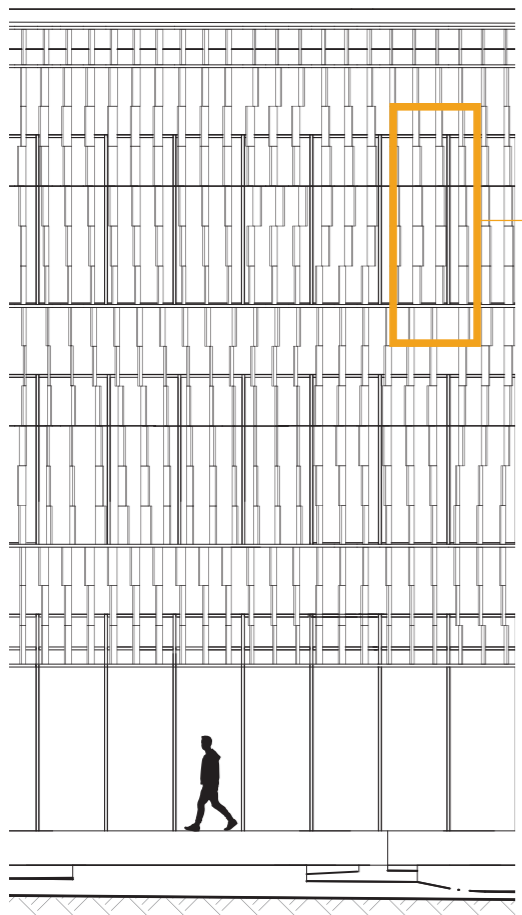

 **Swing System**
Sistema de giro

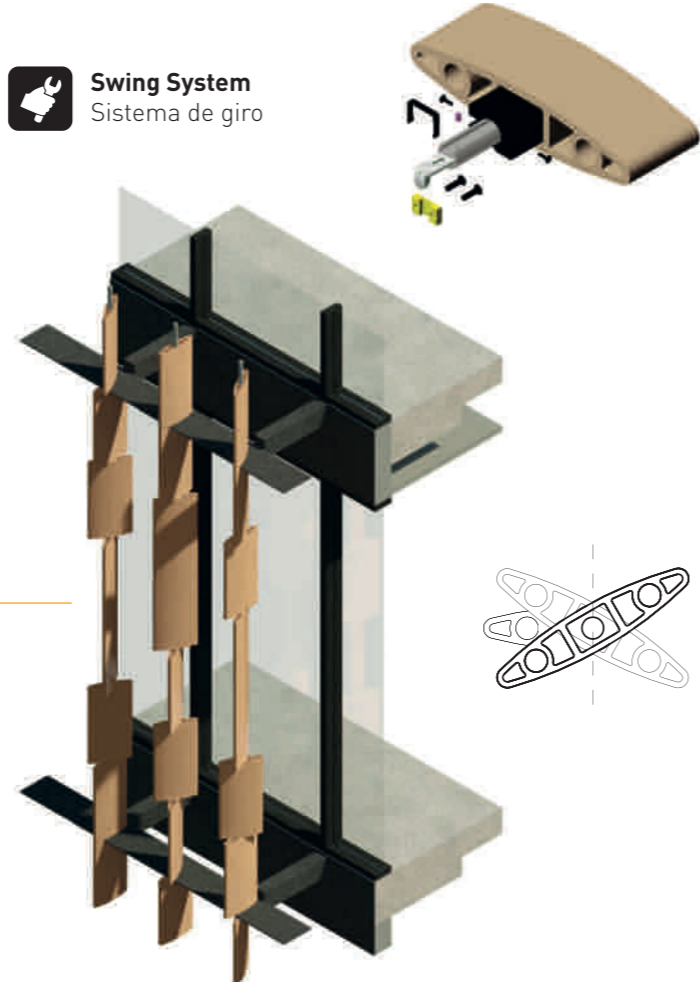

COLOUR PALETTE PALETA DE COLOR



Façade & sunscreen colour palette
Colores para fachada y baguette

*Colours may suffer variations in tone
* Los colores pueden sufrir variaciones de tonalidad

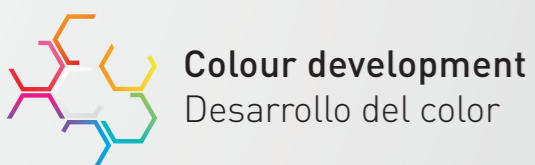

Texture design for façade
Diseño de texturas para fachada

tecnico@ceramicamayor.com



NATURAL

Blanco W00-20	Blanco W2-07	Amarillo Y00-05
Amarillo Y125-15	Amarillo Y05-02	Naranja NA05-05
Naranja NA05-15	Rojo R05-05	Rojo R15-10
Rojo R25-19	Rojo R25-25	Marrón BR2-08
Gris GR1-10	Gris GR02-20	Negro B5-10

MATT MATE	SATIN SATINADO	GLOSS BRILLO		
White Madrid EM2220	White Sevilla ES4220	White Formentera EB3210	Yellow Tanzania EB3660	Yellow Angola EB3680
White Palma EM2230	White Palma ES4230	White Palma EB3230	Red Murano EB3550	Violet Nicaragua EB3985
Grey Foster EM2123	Grey Foster ES4123	Grey Foster EB3123	Violet Monterrey EB3950	Violet Guadalajara EB3990
Grey Arcadia EM2155	Grey Arcadia ES4155	Grey Arcadia EB3155	Blue Orinoco EB3370	Blue Nilo EB3390
Grey Princeton EM2182	Grey Princeton ES4182	Grey Princeton EB3182	Blue Volga EB3315	Green York EB3495
Black Columbia EM2187	Black Columbia ES4187	Black Columbia EB3187	Green Surrey EB3460	Green Leicester EB3480
Marfil Barcelona EM2250	Marfil ES4250			

Colour samples
Solicitud de muestras | www.tempio.es



Specially designed substructure
Subestructura especialmente diseñada

HORIZONTAL SYSTEMS

ANCHOR PLATE SYSTEM

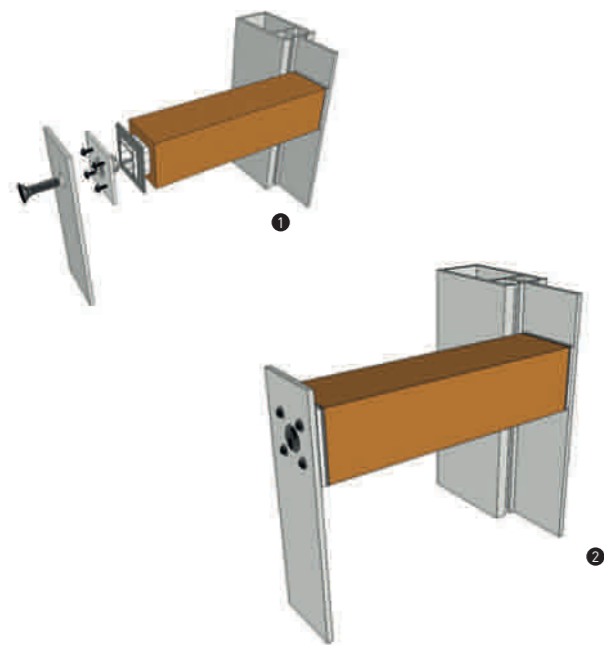

STANDARD SYSTEM

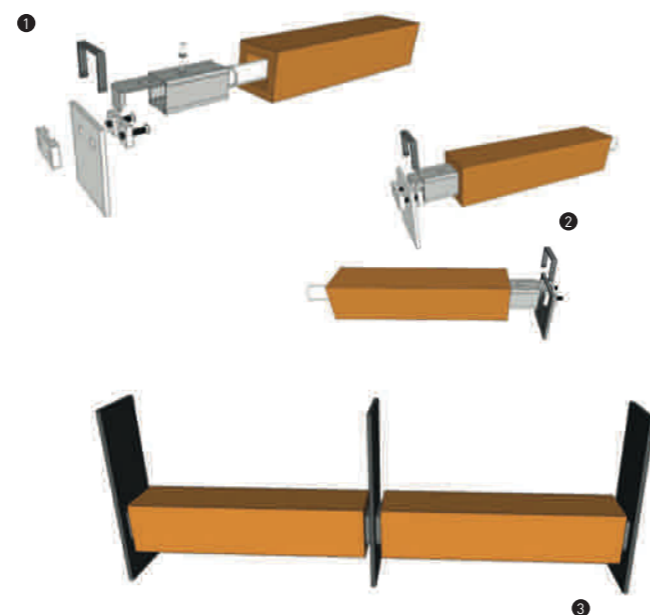

VERTICAL SYSTEMS

POP NUT SYSTEM

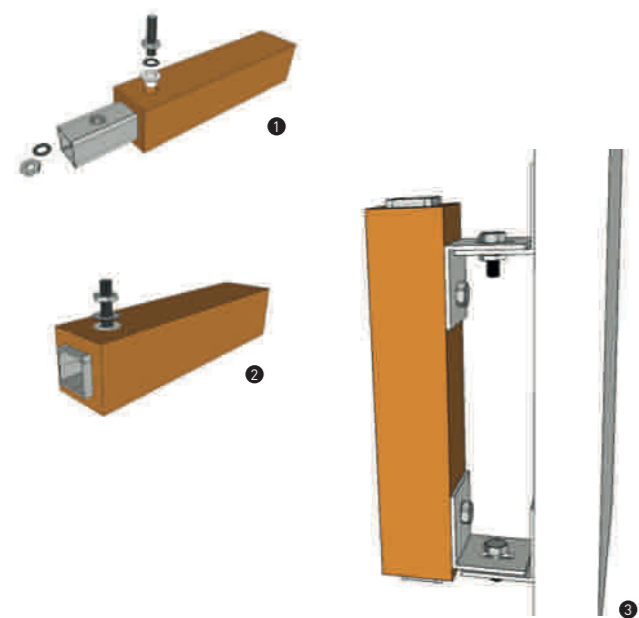

HOOK SYSTEM

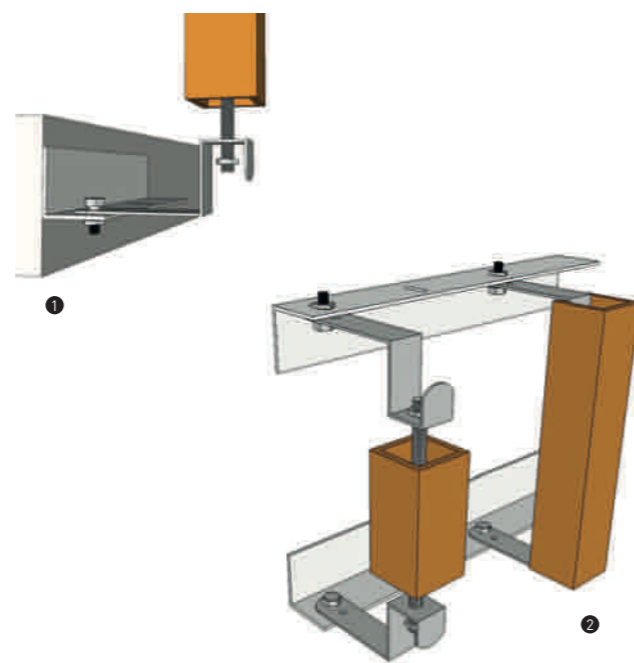

INTERIOR & DESIGN

INTERIORES Y DISEÑO

tempio®

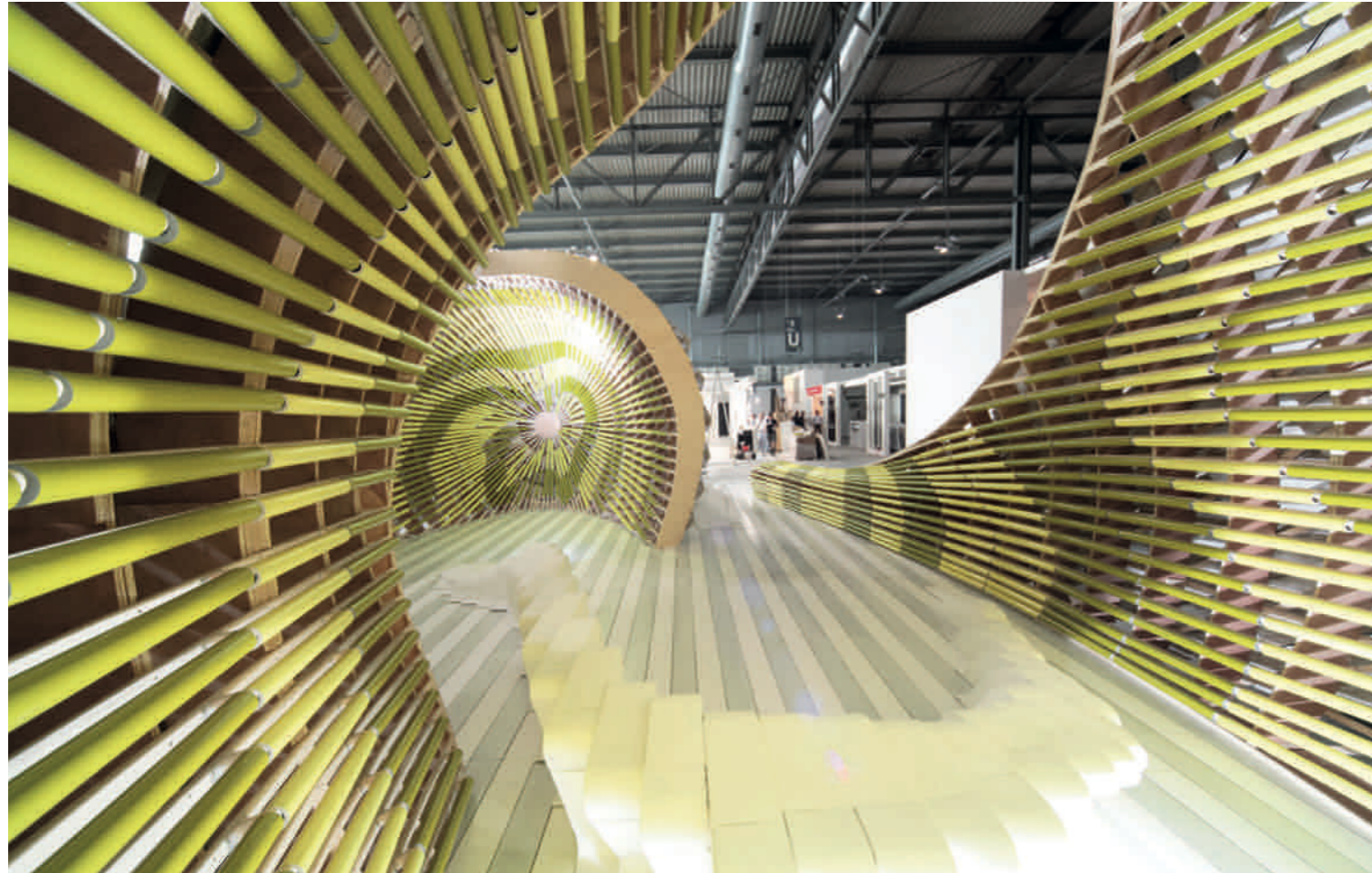

tempio®[projects] Fluidity Exhibition. Valencia, Spain.



tempio®[projects] Primavera Hotel. Benidorm, Spain.

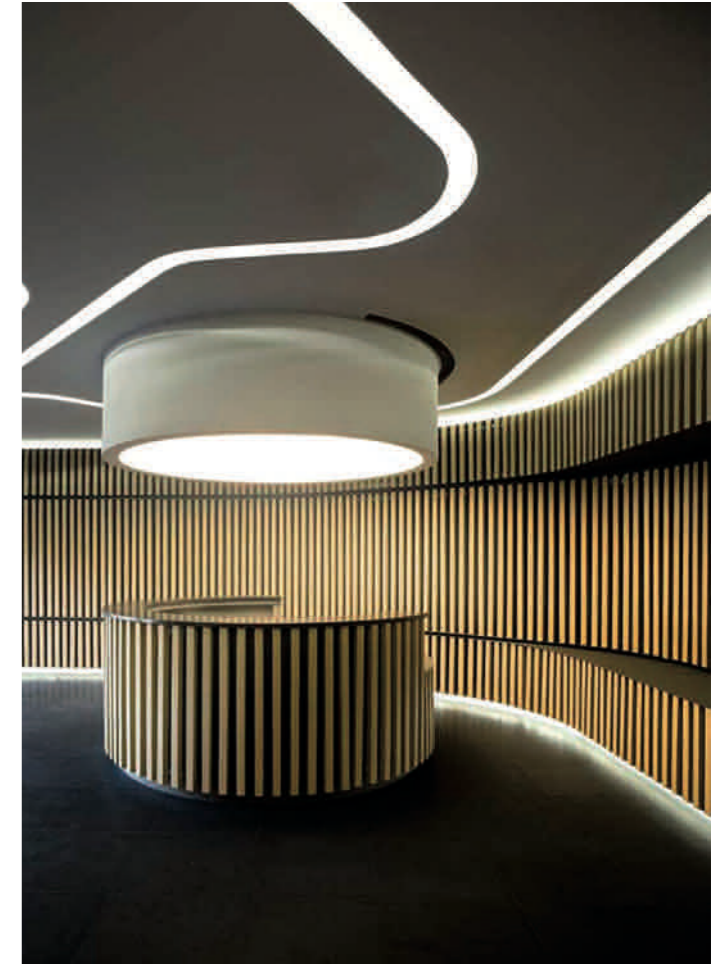

tempio®[projects] Príncipe de Vergara. Madrid, Spain.



Ambient separation
Separación de ambientes

Coating for interior walls and ceilings
Revestimiento de techos y paredes interiores

Ephemeral architecture
Arquitectura efímera



Ambient separation
Separación de ambientes

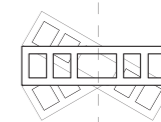

Swing System
Sistema de giro

EDITION - MAR'17

tempio®

CERÁMICA MAYOR, S.A.
Partida Planet, s/n
03510 Callosa d'En Sarrià
(Alicante-España)

T+34 965 881 175
www.ceramicamayor.com

www.tempio.es