

LAYHER SPEEDYSCAF® CATALOGUE



Edition 04.2018
Ref. No. 8102.259

Quality management
certified according
to ISO 9001:2008 20





COMPANY

FROM PAGE 4



| | |
|--------------------------|---|
| Quality "Made by Layher" | 4 |
| More Speed | 5 |
| More Safety | 5 |
| More Proximity | 5 |
| More Simplicity | 5 |
| More Future | 5 |

SCAFFOLDING BASIS

FROM PAGE 8

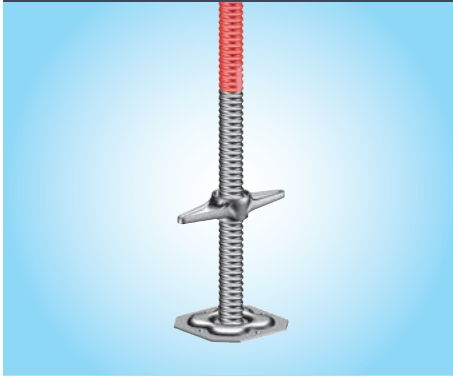

| | |
|---------------------------------------|---|
| Software for scaffolding construction | 8 |
| Base plates | 8 |

BASIC COMPONENTS

FROM PAGE 10

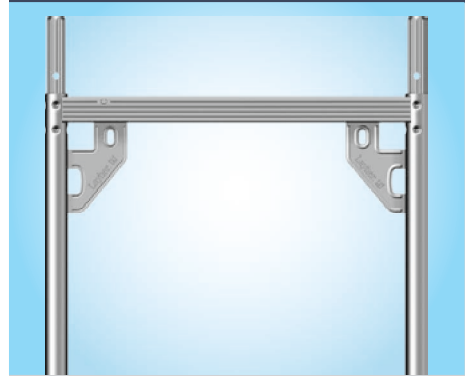

| | |
|-------------------|----|
| Assembly frames | 10 |
| Scaffolding decks | 14 |
| Access decks | 16 |
| Side protection | 18 |
| Diagonal bracing | 20 |



EXTENSION COMPONENTS

FROM PAGE 22



| | |
|----------------------------------------------------------------|----|
| Brackets | 22 |
| Anchoring | 26 |
| Standard brick guard, pedestrian protection, guardrail closure | 28 |
| Stair access, modular stair | 30 |
| System lattice beam, Scaffolding barriers | 32 |
| Accessories | 34 |
| Weather protection, railing clamp | 36 |
| Accessories, tools | 38 |
| Fall protection, scaffolding pallets | 40 |

PRODUCT- PORTFOLIO



| | |
|-------------------------------------------------------|-------------------|
| The Layher product range – all catalogues at a glance | |
| SpeedyScaf system | Ref. No. 8102.259 |
| Allround Scaffolding | Ref. No. 8116.255 |
| System-free Accessories | Ref. No. 8103.257 |
| Protective systems | Ref. No. 8121.257 |
| Event systems | Ref. No. 8111.230 |
| Access Technology | Ref. No. 8118.229 |

NOTICE

All dimensions and weights are guideline values. Subject to technical modification.

Steel components are galvanized according to EN ISO 1461 and DAST guideline 022. Connection parts are galvanized according to EN ISO 4042.

Our deliveries shall be made exclusively in accordance with our currently valid General Terms of Sale. These include the following provisions: The place of performance is Gueglingen-Eibensbach. Title to the delivered goods shall be retained until full payment has been made.

Please request the specific instructions for assembly and use when ordering. Protected by copyright. Not to be reproduced, either in whole or in part. Misprints and errors excepted.

QUALITY MADE BY LAYHER



Headquarters in Eibensbach



Plant 2 in Gueglingen

HERE IS THE BEATING HEART OF LAYHER.

Quality made by Layher comes from Gueglingen-Eibensbach. Our company has set down deep local roots since it was established. Right up until today, development, production, logistics and management are all in one place, where the conditions are best for achieving quality made by Layher: in Gueglingen-Eibensbach. The two locations together cover a surface area of 318,000 m². This includes more than 148,000 m² of covered production and storage areas. This is where our scaffolding systems are created by highly automated production. Short distances and short reaction times mean we can adapt production to suit our customers' requirements, flexibly and at any time.

MORE POSSIBILITIES. THE SCAFFOLDING SYSTEM.

This brand promise made by Layher is the expression of a brand philosophy that we've been living by for over 70 years. More speed, more safety, more proximity, more simplicity and more future: values with which we strengthen our customers' competitiveness in the long term. With our innovative systems and solutions, we're working all the time on making scaffolding construction even simpler, even more economical and, above all, even safer. With comprehensive services, a permanent range of training courses and an ethos of customer focus, more than 1,700 dedicated Layher employees are creating more possibilities for our customers every single day. In more than 40 countries all over the world.



MORE INFORMATION

Discover the world of Layher in its company film at:

yt-image-en.layher.com



MORE SPEED

High level of material availability, effective delivery service and quick assembly and dismantling of the scaffolding systems thanks to 100% fitting accuracy.

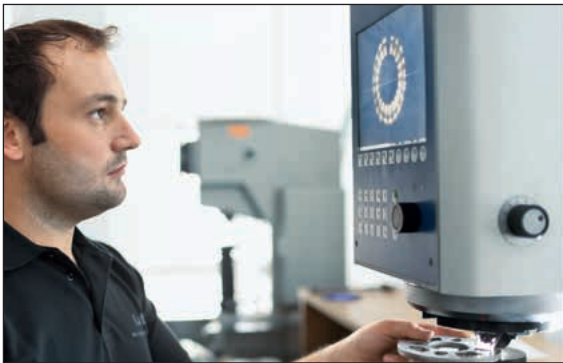

MORE SAFETY

Outstanding quality and precision coupled with a long service life – confirmed internationally through independent certifications, inspections and approvals. Continuity and long-term partnership.

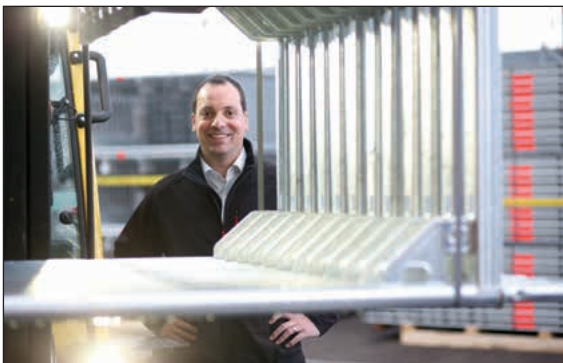

MORE PROXIMITY

Comprehensive personal consultation and close-knit delivery network. Global presence through our own subsidiaries. Family-owned company that works closely with its customers.



MORE SIMPLICITY

Economical scaffolding systems that have been proven in practice, available with an extensive product range. Cross-system combinations for versatile use. Rapid decision making thanks to efficient structures and processes.



MORE FUTURE

Thanks to permanent product innovations and the improvement of existing parts. By opening up new areas of business. With an integrated system to ensure high profitability and retention of investment value. Through an extensive range of training opportunities and seminars to ensure that customers are always right up-to-date with the latest technical and commercial developments.



EASY AND FAST

For decades now, Layher SpeedyScaf equipment has been the recognized leader in insertion-frame systems with the Speedy frame. Modern, fast and robust making it ideal for work on facades. Layher SpeedyScaf is, thanks to its versatile and well thought-out range of parts, equally economical to use in scaffolding construction and in professional trades.

With just six basic elements and a few manual operations, this logically and safely erected scaffolding is very quick because it is assembled without bolts. Numerous expansion parts permit optimum adaptation to existing building geometries – without much extra effort during assembly. SpeedyScaf is available in different scaffolding widths, made of hot-dip galvanized steel or lightweight aluminium, for every application.

This catalogue provides you with an overview of all the basic elements and accessories for the following scaffolding variants:

SpeedyScaf 0.73 m wide, hot-dip galvanized steel,
up to load class 3 as per DIN EN 12811

SpeedyScaf 0.73 m wide, aluminium,
up to load class 3 as per DIN EN 12811

SpeedyScaf 1.09 m wide, hot-dip galvanized steel,
for load classes 4 – 6 as per DIN EN 12811
(depending on deck design and bay length).

The various scaffolding systems of Layher SpeedyScaf are approved with various general building authority approvals:
Z.8.1-16.2 Layher Speedy 70 Steel, Z.8.1-840 Layher Speedy 100 Steel, Z.8.1-844 Layher Speedy 70 Aluminium. Each of these general building authority approvals has its own approval object. The scaffolding components for use in each of the scaffolding systems are derived from the respective general building authority approval.

In addition, there is a type testing for the Layher SpeedyScaf 70 Steel by the test authority of the German Building Authority. This includes 7 assembly variants with platform heights up to 100 m.

YOUR BENEFITS AT A GLANCE

- ▶ Speedy, unlaboured and vertical assembly as well as ergonomic handling thanks to simple insertion technology and lightweight basic elements. Saving in time and cost savings for your success.
- ▶ Uncompromising safety during assembly and maximum stability during assembly and while work thanks to firmly wedged components and non-positively connected.
- ▶ The integrated scaffolding system for easy and complicated applications is fully combinable with all former generations. Maximum investment protection thanks to long durability, purchase availability for decades and continuous enhancements.
- ▶ The comprehensive range of parts and application-oriented accessories are suitable for every trade and application.

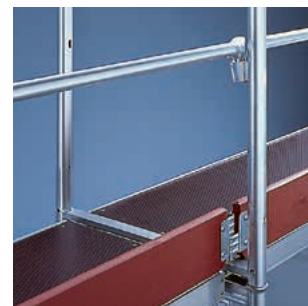

The sum of all advantages cleverly combined: that's the secret behind the success of Layher SpeedyScaf – and hence the secret behind the success of every single user – every single day.

THE INTEGRATED SCAFFOLDING SYSTEM: APPLICATION-ORIENTED ACCESSORIES

Protective Roofs

Layher weather protection roofs can be used in a number of variants depending on their span, the snow load or the wind load. That saves you real money when planning temporary weather protection roofs. For easy use on the site, clearly set-out material and loading capacity tables for snow and wind loads are available for you. Protective roofs are not a one-off solution for Layher, but a standard product – this ensures readiness for immediate delivery.



Protect System

With its Protect System, Layher offers an enclosure system that fits in with Allround Scaffolding and SpeedyScaf. It is used for example for pedestrian protection in combination with the Allround bridging system and also for environmental protection and noise reduction. Highly economical to use thanks to quick and easy assembly in a simple and logical assembly sequence, and the frequent use of a few system components. The Layher Protect System is not a one-off solution for Layher, but a standard product – this ensures readiness for immediate delivery.

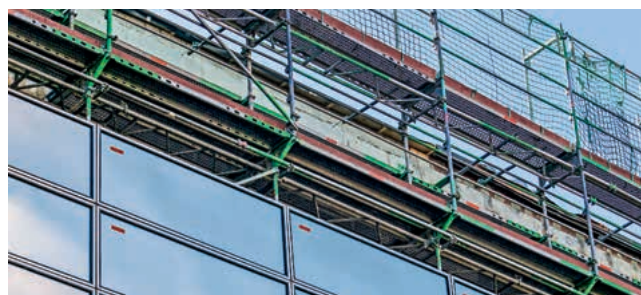

ANTI-THEFT PROTECTION AND ADVERTISING IN ONE

Layher Individual

Assembly frames, Xtra-N-decks, Robust decks, Stalu decks, steel decks can be stamped individually. Wooden toe boards can be printed according to your preferences.



Software for scaffolding construction

Layher LayPLAN

Time and material are crucial factors in scaffolding construction. To make the most efficient use of both, the Layher range includes the practical LayPLAN scaffolding planning software.

With the several software packages LayPLAN CLASSIC and LayPLAN CAD, it is possible to plan scaffolding structures from simple, small facade scaffolding up to complex industrial scaffolding or protective roofs and grandstands.

LayPLAN CLASSIC

With the LayPLAN CLASSIC modules for Allround Scaffolding and SpeedyScaf, individualised scaffolding solutions can be configured quickly and easily: whether they're for circular or facade scaffolding made from SpeedyScaf, for birdcage scaffolding and free-standing towers made from Allround Scaffolding, or for structures with temporary roofs. Once the dimensions and the required assembly variant have been entered, LayPLAN CLASSIC delivers within seconds a scaffolding proposal, including anchoring, bracing and side protection. During the design phase, the overall length, standing heights and areas are continuously calculated and displayed to reflect the current plan. A materials list can also be created at the click of a button and then printed out, together with an assembly sketch for the area to be enclosed in scaffolding plus the total weight. This also helps with the logistics – the required material is guaranteed to be there where it's needed. Scaffolding erectors benefit from more certainty when planning the commercial and technical details, from optimised use of stocks, and from full cost transparency at every stage of the project.

After finalisation of the scaffolding proposal, the LayPLAN Material Manager provides you with complete lists of required parts to ensure you always have precisely the material you need at the site.

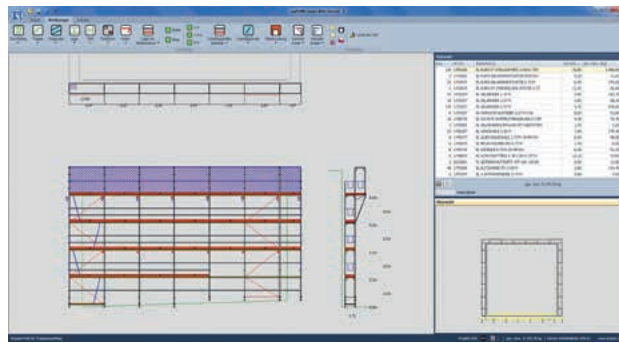

SpeedyScaf facade scaffolding with console bracket surface and brick guard nets

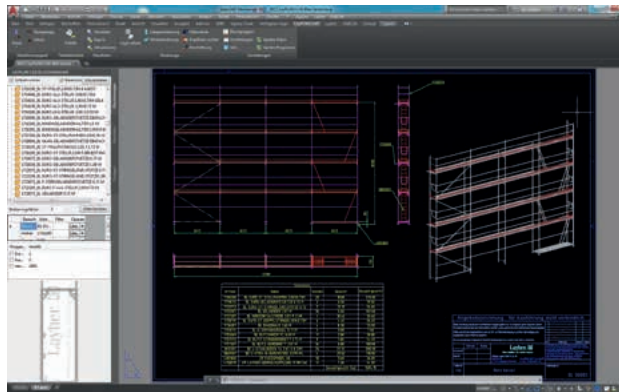

Planning of individualised scaffolding structures in LayPLAN CAD

Base plates

To adjust to the ground, choose between different height-adjustable **base plates** with sturdy and self-cleaning round threads, with colour and notch markings to provide protection against overwinding. Make sure that there are sufficient load-distributing surfaces.

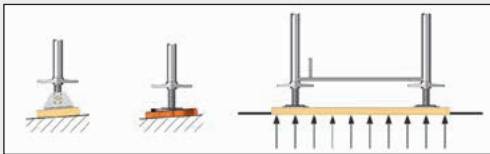

The round threads of all Layher scaffolding spindles have an outside diameter of 38 mm. The wing external dimension of the spindle nut is 205 mm. The dimensions of the foot plate are 150 x 150 mm.

Further information can be found in the catalogue for System-free Accessories.

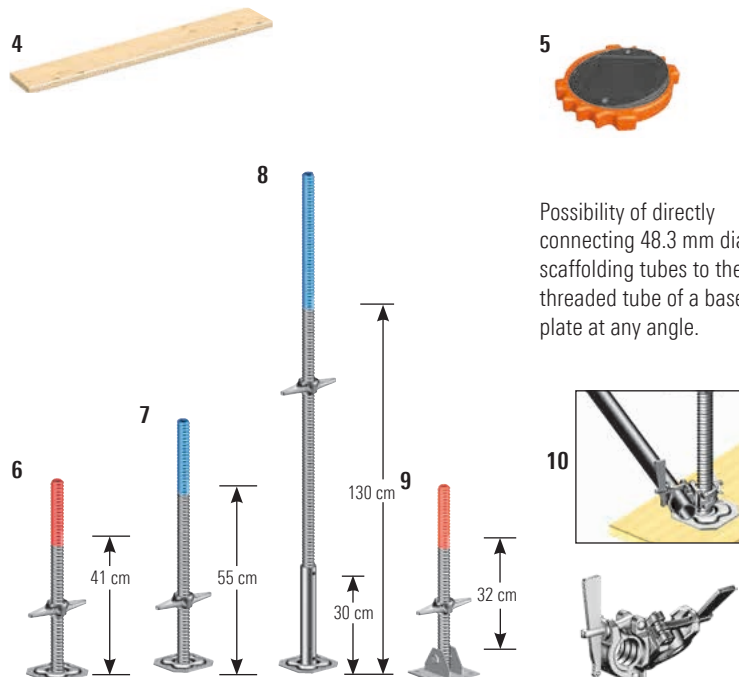

Possibility of directly connecting 48.3 mm dia. scaffolding tubes to the threaded tube of a base plate at any angle.

LayPLAN CAD

For more complex structures, LayPLAN CAD is available. This is a plug-in for Autodesk AutoCAD. It enables 3-dimensional planning of scaffolding structures of all types.

Thanks to integration into the LayPLAN system, the basic planning can be handled in automated form using the proven LayPLAN CLASSIC. Project data can be quickly recorded using input masks, ensuring a time saving for every order. The data are then simply exported into the AutoCAD program, which offers further possibilities for detailed 3D planning. A visual collision check is possible with the aid of volume rendering. Using a convenient search function with preview image, scaffolding planners will find not only an extensive library of individual Layher parts, but also assemblies already prefabricated for even faster design work. The detailed drawings can then be printed out. It is possible to export them as 3D PDFs too (3D PDF exporter only included with LayPLAN CAD OEM version), which brings benefits in the tender phase and also facilitates later assembly. A transfer to visualisation or animation software is also possible without any problem. This allows projects not only to be planned economically and also adapted precisely to actual requirements, but also to be presented professionally to customers.

How can I acquire LayPLAN?

Registration and all the ordering processes can be conveniently accessed at the Layher website: <http://software.layher.com>

A contact form gives you the data to access our software portal, where you can download a 30-day test version and also find the order form for the full version.

The individual software packages can be licensed for a validity of 1 year from our sales partner *Mensch und Maschine Deutschland GmbH*, which also handles the entire sales process and provides continuous hotline support for these packages. The license is extended by a further year if a subscription model is selected, unless it is terminated with two months notice to the end of the contractual year.

| Pos. | Description |
|------|---------------------------------------------------------------------------------------------------------------------------------------------------------------------------------------------------|
| 1 | LayPLAN CLASSIC scaffolding configurator for SpeedyScaf, Allround Scaffolding, weather protection roofs and rolling towers |
| 2 | LayPLAN CAD plug-in for AutoCAD, for designing complex scaffolding in 3D and for developing scaffolding proposals from LayPLAN CLASSIC |
| 3 | LayPLAN CAD OEM AutoCAD 2017 OEM with LayPLAN CAD plug-in for designing complex scaffolding in 3D, incl. 3D PDF exporter, and for developing scaffolding proposals from LayPLAN CLASSIC |

| Pos. | Description | Dimensiones L / H x W [m] | Weight approx. [kg] | PU [pcs.] | Ref. No. |
|------|-------------------------------------------------------------------------------------------------------------------|------------------------------|------------------------|--------------|----------|
| 4 | Scaffolding plank for load distribution 45 mm high, freshly sawn, sorting category S10 | 1.00 x 0.24 | 5.2 | | 3816.100 |
| | | 1.50 x 0.24 | 7.8 | | 3816.150 |
| 5 | Adjustment plate for base plate of glass-fibre-reinforced polyamide plastic, inclination 0 – 16% | Ø 0.30 | 1.3 | 250 | 4000.400 |
| 6 | Base plate 60 (max. spindle travel 41 cm) | 0.60 | 3.6 | 200 | 4001.060 |
| 7 | Base plate 80, reinforced (max. spindle travel 55 cm) | 0.80 | 4.9 | 200 | 4002.080 |
| 8 | Base plate 150, reinforced (max. spindle travel 100 cm), ensure sufficient structural strength | 1.50 | 10.0 | 100 | 4002.130 |
| 9 | Swivelling base plate 60, reinforced (max. spindle travel 32 cm), ensure sufficient structural strength | 0.60 | 6.1 | 100 | 4003.000 |
| 10 | Wedge spindle swivel coupler | | 1.8 | 25 | 4735.000 |

WS = wrench size PU = packaging unit = available ex works = delivery time on request = only available in this packaging unit = the approval process is not yet completed

= Layher Individual possible – see page 7

Assembly frames

Adjustment frames



The scaffolding can be adapted to the lie of the land with 0.66 m, 1.00 m and 1.50 m adjustment frames. Assembly always begins at the highest point. The 1.50 x 1.09 m assembly frame has two guardrail wedge housings, making it suitable for use in bricklayer's scaffolding.

Internal scaffolding access

Our hatch-type access decks conform to the requirements of DIN EN 12811, with a separate or an integrated storey ladder for internal access.

A deck must be fitted using **U-start ledgers** or **SpeedyScaf transoms** as the erection surface for the lowest ladders.

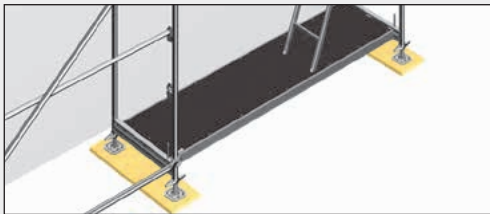



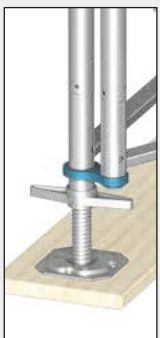

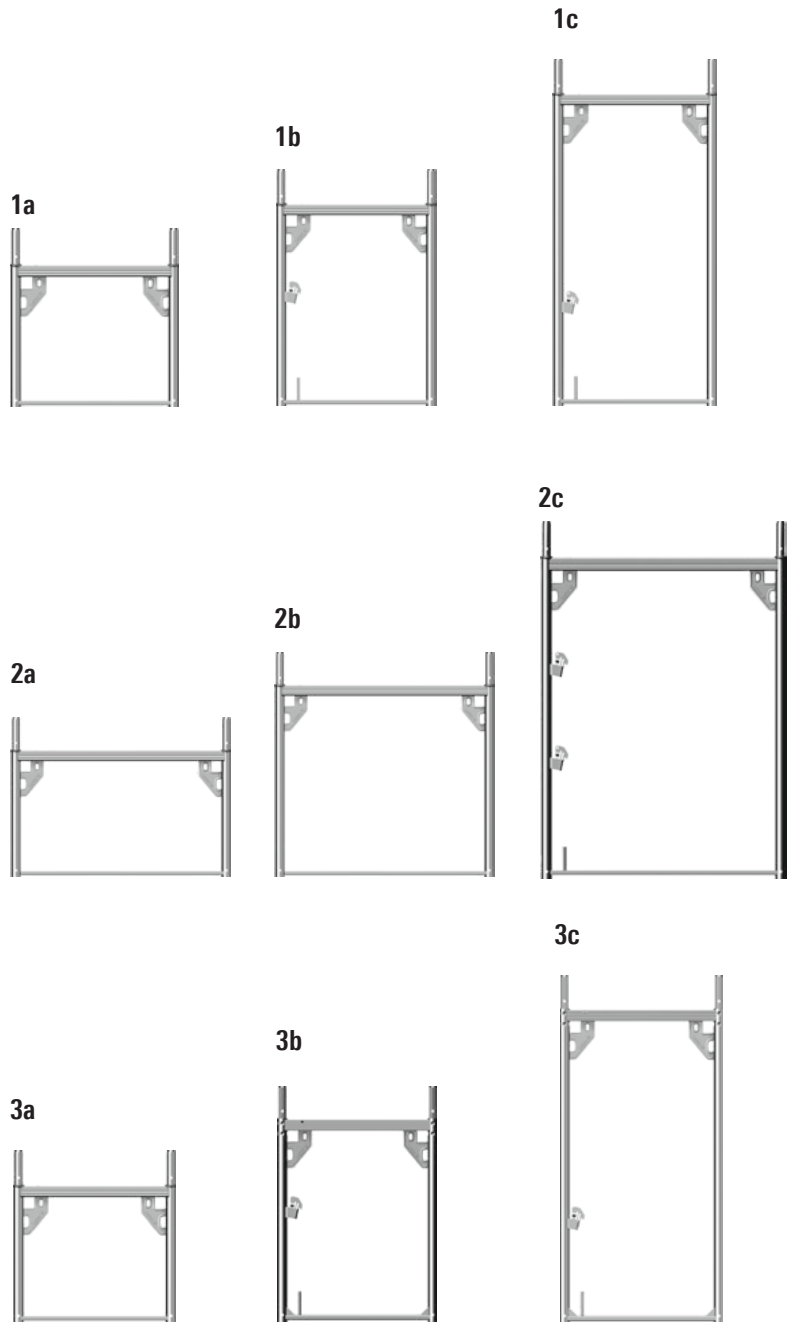

If base ledgers (see page 21, Pos. 6) are mounted and U-base sections are fitted on the above assembly frames, the deck above the adjustment frame can be removed for special uses.



The corner adapter for circular scaffolding and corner solutions considerably simplifies this assembly step. It is fitted onto the base plates before fitting of the bottom assembly frame, and then permits subsequent fitting of two assembly frames next to one another, without attaching a coupler at the bottom. Both assembly frames are automatically aligned at the same height. The axial dimensions of the adaptor is the same as of the swivel coupler.



| Pos. | Description | Dimensions L / H x W [m] | Weight approx. [kg] | PU [pcs.] | Ref. No. |
|------|-----------------------------------------------------------------------------------------------------------------------------------------------------------------------------------------------------------------------------------------------|-----------------------------|------------------------|--------------|-------------------------------------------------------------------------------------------------------|
| 1 | Assembly frame LW, steel, IND a) Adjustment frame 0.66 x 0.73 m b) Adjustment frame 1.00 x 0.73 m* c) Adjustment frame 1.50 x 0.73 m* *with 1 guardrail wedge housing and toe board pin | | | | |
| | | 0.66 x 0.73 | 9.3 | 75 | 1700.066 |
| | | 1.00 x 0.73 | 11.9 | 50 | 1700.101 |
| | | 1.50 x 0.73 | 15.8 | 24 | 1700.150 |
| 2 | Assembly frame LW, steel, IND a) Adjustment frame 0.66 x 1.09 m b) Adjustment frame 1.00 x 1.09 m c) Adjustment frame 1.50 x 1.09 m* *with 2 guardrail wedge housings and toe board pin | | | | |
| | | 0.66 x 1.09 | 11.5 | 75 | 1780.066  |
| | | 1.00 x 1.09 | 13.8 | 50 | 1780.100  |
| | | 1.50 x 1.09 | 14.9 | 24 | 1780.150  |
| 3 | Assembly frame, aluminium, a) Adjustment frame 0.66 x 0.73 m b) Adjustment frame 1.00 x 0.73 m* c) Adjustment frame 1.50 x 0.73 m* *with 1 guardrail wedge housing and toe board pin | | | | |
| | | 0.66 x 0.73 | 4.1 | 75 | 1714.066 |
| | | 1.00 x 0.73 | 5.2 | 50 | 1714.101 |
| | | 1.50 x 0.73 | 6.7 | 24 | 1714.150  |
| 4 | U-base section, steel, galvanized | 0.73 | 2.2 | | 1750.073  |
| | | 1.09 | 3.2 | | on request |
| 5 | Starter U-transom | 0.73 | 3.8 | 42 | 1751.073 |
| | | 1.09 | 5.1 | 42 | 1751.109  |
| 6 | SpeedyScaf corner adapter  Axial dimensions 74 mm | 0.074 | 1.3 | | 1704.074 |

WS = wrench size PU = packaging unit  = available ex works  = delivery time on request  = only available in this packaging unit  = the approval process is not yet completed

IND = Layher Individual possible – see page 7

Assembly frames

Speedy assembly frames Lightweight

The construction principle of the assembly frames ensures speedy, and stable assembly: The upper crosspiece is designed as a channel section into which the decks slide easily during assembly. The corner plate for receiving the diagonal braces and the guardrail wedge housings for dropping in the guardrails require no direct fitting or "aiming"; striking with a hammer blow ensures positive stable connections. The lower rectangular tube secures the decks automatically for further extension and the toe board pin accommodates the toe boards.

Advantages of the assembly frame Lightweight:

- ▶ Low weight
- ▶ Very rapid assembly of internal guardrails
- ▶ Versatile possibilities for anchoring
- ▶ Fast vertical assembly without a spirit level
- ▶ Maximum height clearance

All wall thicknesses are approved for the connection of couplers. The handy Layher assembly frame has no outwardly projecting parts – it runs smoothly through the hands, and is therefore ergonomic. Very low external dimensions save on transportation and storage space.

The **gantry frame LW 6** for safe protection of pedestrians underneath the scaffolding, by rebolting the central spigot for 0.73 m or 1.09 m scaffolding width.









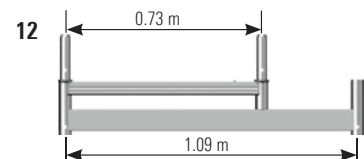
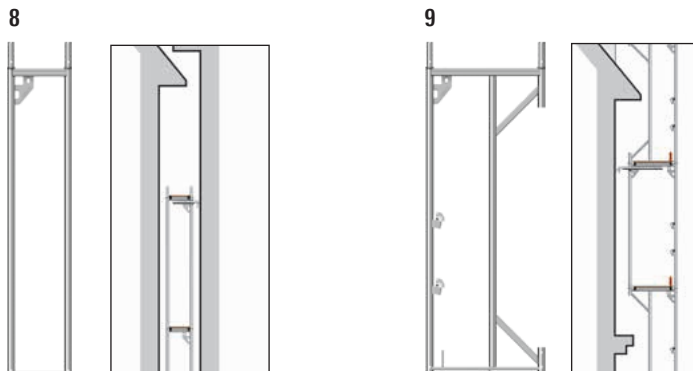
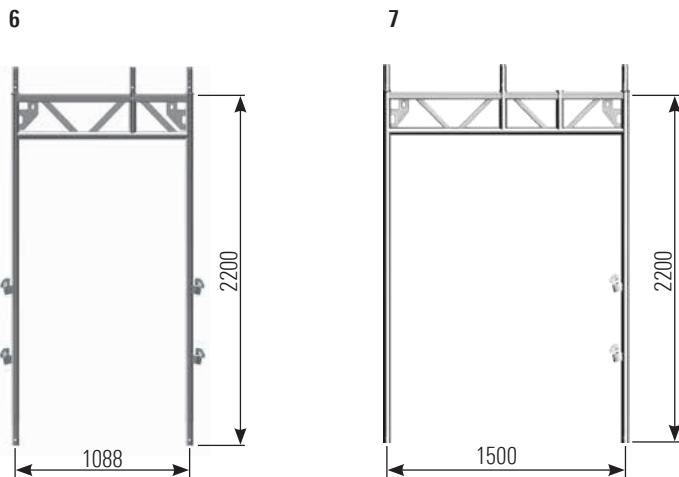
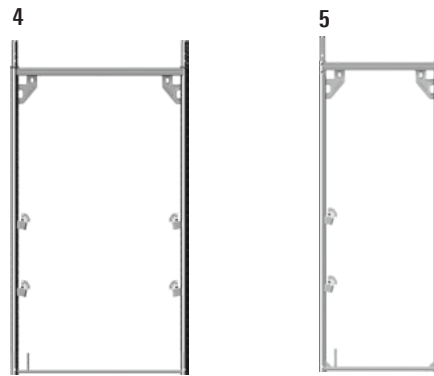
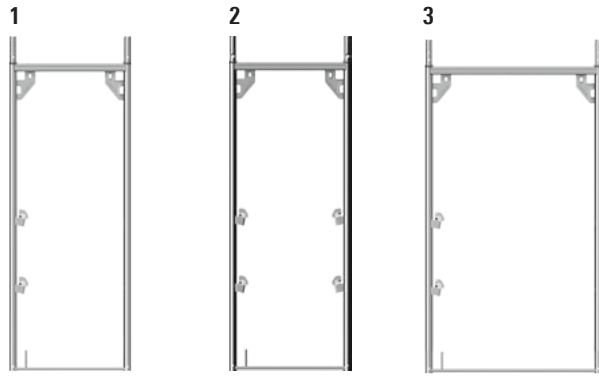

Adapters for continuing with 0.73 m frames (Ref. No. 0732.299) upon request.

The assembly frame lightweight, 2.00 m, for **balustrade 9** is used where a roof projection projects into the scaffolding. Above it, a maximum of four further levels can be constructed using standard assembly frames.

The assembly frame joints are secured with **locking pins 10** in special cases against unintentional lifting off, for example when scaffolding units are moved with a crane, when brick guard supports are used or in particular wind conditions (see assembly instructions).

With the **reducer from 1.09 m to 0.73 m 12**, it is possible to reduce the scaffolding width from 1.09 m to 0.73 m. This can be necessary for example at great heights for structural reasons. This makes it possible to use assembly frames 70 on a substructure of meter-wide scaffolding.



| Pos. | Description | IND | Dimensions L/H x W [m] | Weight approx. [kg] | PU [pcs.] | Ref. No. |
|------|------------------------------------------------------------------------------------------------------------------------------------------------------------|-----|---------------------------|------------------------|------------------------------------------------------------------------------------------|--------------------------------------------------------------------------------------------------------------------------------------------------------------------------------------|
| 1 | Speedy assembly frame LW, steel, Standard frame 2.00 x 0.73 m with 2 guardrail wedge housings (only external guardrails) | IND | 2.00 x 0.73 | 18.8 | 24 | 1700.200 |
| 2 | Speedy assembly frame LW, steel, Standard frame 2.00 x 0.73 m with 4 guardrail wedge housings (external and internal guardrails) | IND | 2.00 x 0.73 | 19.6 | 24 | 1710.200  |
| 3 | Speedy assembly frame LW, steel Standard frame 2.00 x 1.09 m, with 2 guardrail wedge housings (only external guardrails) | IND | 2.00 x 1.09 | 21.5 | 24 | 1780.200 |
| 4 | Speedy assembly frame LW, steel Standard frame 2.00 x 1.09 m, with 2 guardrail wedge housings (only external guardrails) | IND | 2.00 x 1.09 | 22.3 | 24 | 1785.200  |
| 5 | Speedy assembly frame, aluminium Standard frame 2.00 x 0.73 m | | 2.00 x 0.73 | 8.6 | 24 | 1714.200 |
| 6 | Gantry frame LW  steel, hot-dip galvanized | | 2.20 x 1.09 | 28.4 | 24 | 1779.109 |
| 7 | Gantry frame LW steel, hot-dip galvanized | | 2.20 x 1.50 | 31.2 | 24 | 1779.150 |
| 8 | Speedy assembly frame LW, steel narrow assembly frame 2.00 x 0.36 m | | 2.00 x 0.36 | 18.3 | 50 | 1717.200 |
| 9 | Speedy assembly frame LW, 2.00 m, for balustrade steel, hot-dip galvanized | | 2.00 x 0.73 | 22.7 | 25 | 1718.200 |
| 10 | Locking pin, red, dia. 11 mm | | | 0.2 | 4000 | 4000.001 |
| 11 | Guardrail wedge housing cover Polypropylene | | | 0.6 | 10  | 1710.003   |
| 12 | Reducer from 1.09 m to 0.73 m  with welded-on channel section | | 1.09 | 8.3 | 20 | 4027.000  |

WS = wrench size PU = packaging unit  = available ex works  = delivery time on request  = only available in this packaging unit  = the approval process is not yet completed

IND = Layher Individual possible – see page 7

Scaffolding decks

Our scaffolding decks comply with the requirements of DIN EN 12811.

In the Layher system, depending on the type of application and scaffolding group but also in accordance with your working requirements and priorities, choose from decks made of hot-dip galvanized steel, aluminium, wood or an aluminium frame with plywood board. The load-bearing capacity of the overall system must be observed. The claws of the Layher scaffolding decks slide easily during assembly into the U-sections of the assembly frame, ensuring unbeatable speed of assembly.

The **U-Xtra-N deck 4** is identical in construction with the robust deck, but is equipped with a glass-fibre-reinforced plastic plate. It is very weather-resistant: No rotting, no fungus growth, no split-open rivet holes. The breaking load of the plastic plate is about 3 times that of dry plywood. The surface has a proven anti-slip structure, which is very easy to clean. Plaster and dirt can be easily removed by using a high-pressure cleaner or a scraper.

The **U-stalu deck 6-8** is a lightweight and durable aluminium deck with sturdy, riveted steel caps.

Individual stamping

The Layher steel decks can be provided with individual lettering. Conspicuously visible on the side section, they give the Layher steel deck that certain something. Individual stampings offer also a high-class anti-theft protection.



Similar to the steel decks, also the Stalu, Xtra-N and robust decks can be individualized. The stamping is particularly high-quality. The needle stamping process provides fine and very precise lettering.

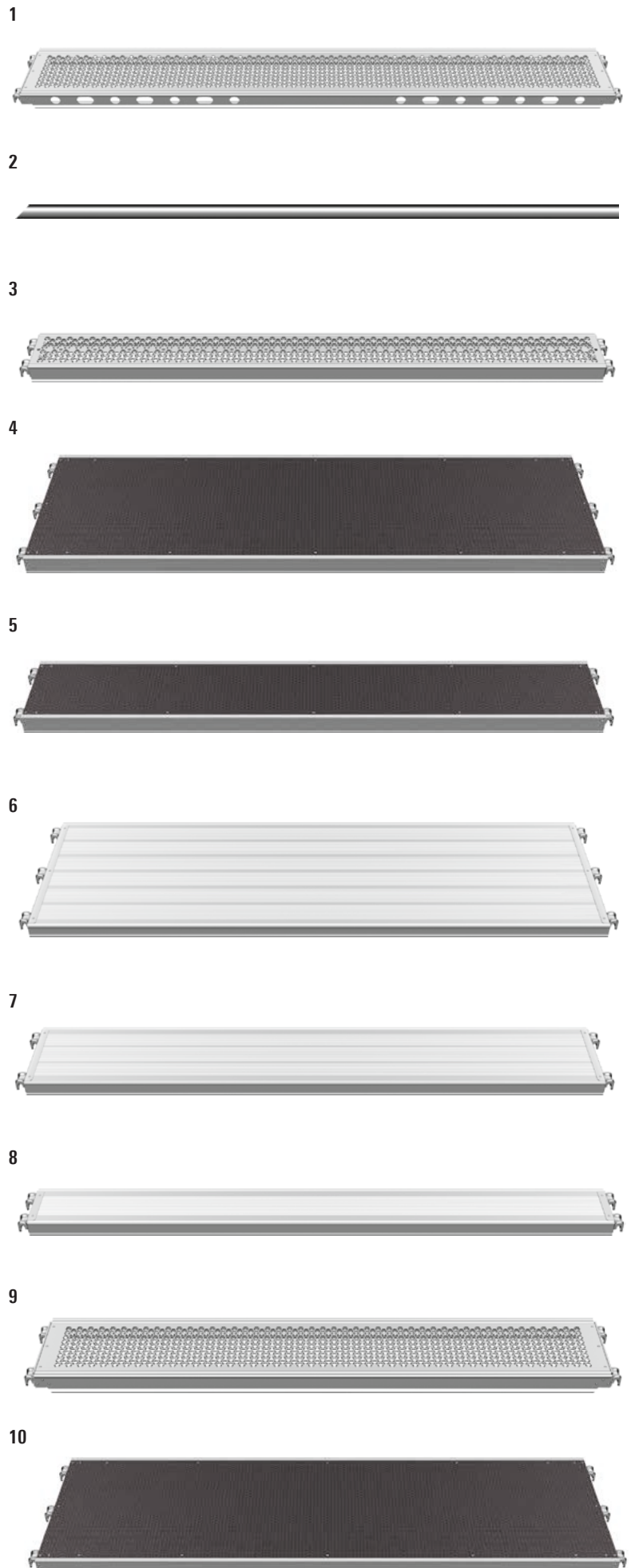

| Pos. | Description | Use up to load class | Dimensions L/H x W [m] | Weight approx. [kg] | PU [pcs.] | Ref. No. |
|------|-------------------------------------------------------------------------------------------------------------------------------------------------------------------------------|----------------------|---------------------------|------------------------|--------------|----------|
| 1 | U-steel deck T4, 0.32 m wide steel, hot-dip galvanized perforated, non-slip working surface | IND | 6 0.73 x 0.32 | 6.0 | 60 | 3812.073 |
| | | | 6 1.09 x 0.32 | 8.4 | 60 | 3812.109 |
| | | | 6 1.29 x 0.32 | 9.8 | 60 | 3802.129 |
| | | | 6 1.40 x 0.32 | 10.6 | 60 | 3802.140 |
| | | | 6 1.57 x 0.32 | 11.9 | 60 | 3812.157 |
| | | | 6 2.07 x 0.32 | 15.0 | 60 | 3812.207 |
| | | | 5 2.57 x 0.32 | 18.2 | 60 | 3812.257 |
| | | | 4 3.07 x 0.32 | 21.5 | 60 | 3812.307 |
| 2 | Steel tube, 33.7 mm , hot-dip galvanized Fits through the edge holes of Ref. No. 3812 | | 1.50 | 3.0 | 100 | 4603.150 |
| | | | | | | |
| 3 | U-steel deck, 0.19 m wide constructed as 3812 as equalizing deck, e.g. for birdcage scaffolding | IND | 6 0.73 x 0.19 | 5.1 | 50 | 3801.073 |
| | | | 6 1.09 x 0.19 | 6.4 | 50 | 3801.109 |
| | | | 6 1.29 x 0.19 | 7.4 | 50 | 3801.129 |
| | | | 6 1.40 x 0.19 | 8.0 | 50 | 3801.140 |
| | | | 6 1.57 x 0.19 | 8.5 | 50 | 3801.157 |
| | | | 6 2.07 x 0.19 | 10.2 | 50 | 3801.207 |
| | | | 5 2.57 x 0.19 | 13.2 | 50 | 3801.257 |
| | | | 4 3.07 x 0.19 | 15.3 | 50 | 3801.307 |
| 4 | U-Xtra-N deck, 0.61 m wide Aluminium stile section, glass-fibre-reinforced plastic plate extremely durable, lightweight, non-slip working surface | IND | 3 0.73 x 0.61 | 7.0 | 60 | 3866.073 |
| | | | 3 1.09 x 0.61 | 9.5 | 60 | 3866.109 |
| | | | 3 1.57 x 0.61 | 13.0 | 40 | 3866.157 |
| | | | 3 2.07 x 0.61 | 16.2 | 40 | 3866.207 |
| | | | 3 2.57 x 0.61 | 19.0 | 40 | 3866.257 |
| | | | 3 3.07 x 0.61 | 23.5 | 40 | 3866.307 |
| 5 | U-Xtra-N deck, 0.32 m wide constructed as Ref. No. 3835 as console or equalizing deck, e.g. for birdcage scaffolding | IND | 6 1.57 x 0.32 | 9.6 | 30 | 3877.157 |
| | | | 5 2.07 x 0.32 | 11.2 | 30 | 3877.207 |
| | | | 4 2.57 x 0.32 | 14.3 | 30 | 3877.257 |
| | | | 3 3.07 x 0.32 | 15.5 | 30 | 3877.307 |
| 6 | U-stalu deck T9, 0.61 m wide extremely lightweight aluminium deck with sturdy, riveted steel caps, stacking height only 54 mm | IND | 6 0.73 x 0.61 | 6.6 | 40 | 3867.073 |
| | | | 6 1.09 x 0.61 | 8.8 | 40 | 3867.109 |
| | | | 6 1.57 x 0.61 | 11.7 | 40 | 3867.157 |
| | | | 6 2.07 x 0.61 | 14.8 | 40 | 3867.207 |
| | | | 5 2.57 x 0.61 | 17.9 | 40 | 3867.257 |
| | | | 4 3.07 x 0.61 | 21.0 | 40 | 3867.307 |
| 7 | U-stalu deck T9, 0.32 m wide constructed as 3867 as equalizing deck, e.g. for birdcage scaffolding | IND | 6 1.57 x 0.32 | 7.4 | 30 | 3856.157 |
| | | | 6 2.07 x 0.32 | 9.2 | 30 | 3856.207 |
| | | | 5 2.57 x 0.32 | 11.0 | 30 | 3856.257 |
| | | | 4 3.07 x 0.32 | 13.3 | 30 | 3856.307 |
| 8 | U-stalu deck T9, 0.19 m wide constructed as 3867 as equalizing deck, e.g. for birdcage scaffolding | | 6 1.57 x 0.19 | 5.6 | 50 | 3857.157 |
| | | | 6 2.07 x 0.19 | 7.2 | 50 | 3857.207 |
| | | | 5 2.57 x 0.19 | 8.7 | 50 | 3857.257 |
| | | | 4 3.07 x 0.19 | 10.2 | 50 | 3857.307 |
| 9 | U-alu deck, perforated, 0.32 m wide Deck and caps of aluminium with robust steel claws perforated, non-slip working surface | | 6 0.73 x 0.32 | 3.1 | 60 | 3803.073 |
| | | | 6 1.09 x 0.32 | 4.4 | 60 | 3803.109 |
| | | | 6 1.57 x 0.32 | 6.5 | 60 | 3803.157 |
| | | | 5 2.07 x 0.32 | 8.0 | 60 | 3803.207 |
| | | | 4 2.57 x 0.32 | 10.0 | 60 | 3803.257 |
| | | | 3 3.07 x 0.32 | 11.5 | 60 | 3803.307 |
| 10 | U-robust deck, 0.61 m wide Aluminium stile section, plywood panel BFU 100G phenolic resin coating and rot protection; lightweight, non-slip, easily stackable | IND | 3 0.73 x 0.61 | 7.2 | 60 | 3835.073 |
| | | | 3 1.09 x 0.61 | 9.7 | 60 | 3835.109 |
| | | | 3 1.57 x 0.61 | 13.1 | 40 | 3835.157 |
| | | | 3 2.07 x 0.61 | 16.4 | 40 | 3835.207 |
| | | | 3 2.57 x 0.61 | 19.3 | 40 | 3835.257 |
| | | | 3 3.07 x 0.61 | 24.2 | 40 | 3835.307 |

WS = wrench size PU = packaging unit  = available ex works  = delivery time on request  = only available in this packaging unit  = the approval process is not yet completed

IND = Layher Individual possible – see page 7

Access decks, steel planks, gap decks

Internal scaffolding access

Our hatch-type access decks conform to the requirements of DIN EN 12811, with a separate or an integrated storey ladder for internal access

A deck must be fitted using **U-start ledgers** or **SpeedyScaf transoms** as the erection surface for the lowest ladders (see page 10/11).

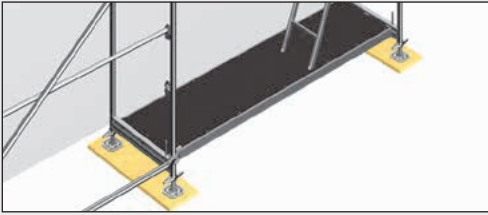

External scaffolding access

Aluminium platform stairs with guardrails for convenient external access allowing the transportation of materials (see page 30).

Corner deck, adjustable 6

In the case of adjoining frame bays in 0.73 m wide scaffolding, the corners are covered with corner decks. System-conforming covers are therefore no longer a problem and you have a continuous deck surface with no risks of tripping or stumbling.

Hatch-type access with offset hatch 10/11/12/13

The offset hatch can be opened and closed even when bridging decks are placed on top.

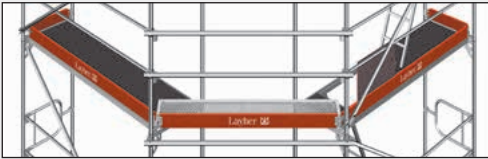

The **steel plank 15** is a safe bridging element capable of bearing high loads for all scaffolding systems. It is preferred to wooden planks for use in areas with stringent fire protection requirements.

- ▶ Long service life, reusable
- ▶ Lower weight compared with wood plank
- ▶ Non-slip and non-inflammable
- ▶ If at least 2 steel planks are adjacent to one another, they may also be used in brick guards

The support length must be at least 10 cm at every support.

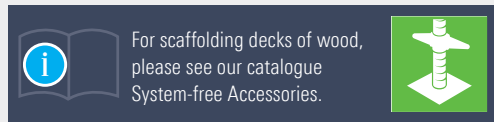

Secure the planks with locking pins, 2 self securing steel bolts or 1 securing screw for each end.



For closing of system-caused gaps, **gap covers 14** or the **telescopic gap deck 18** can be used.

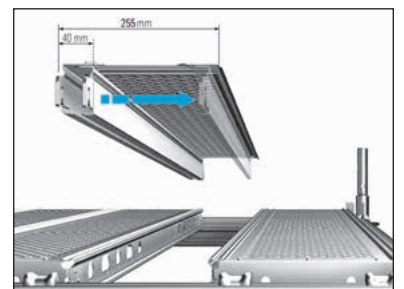
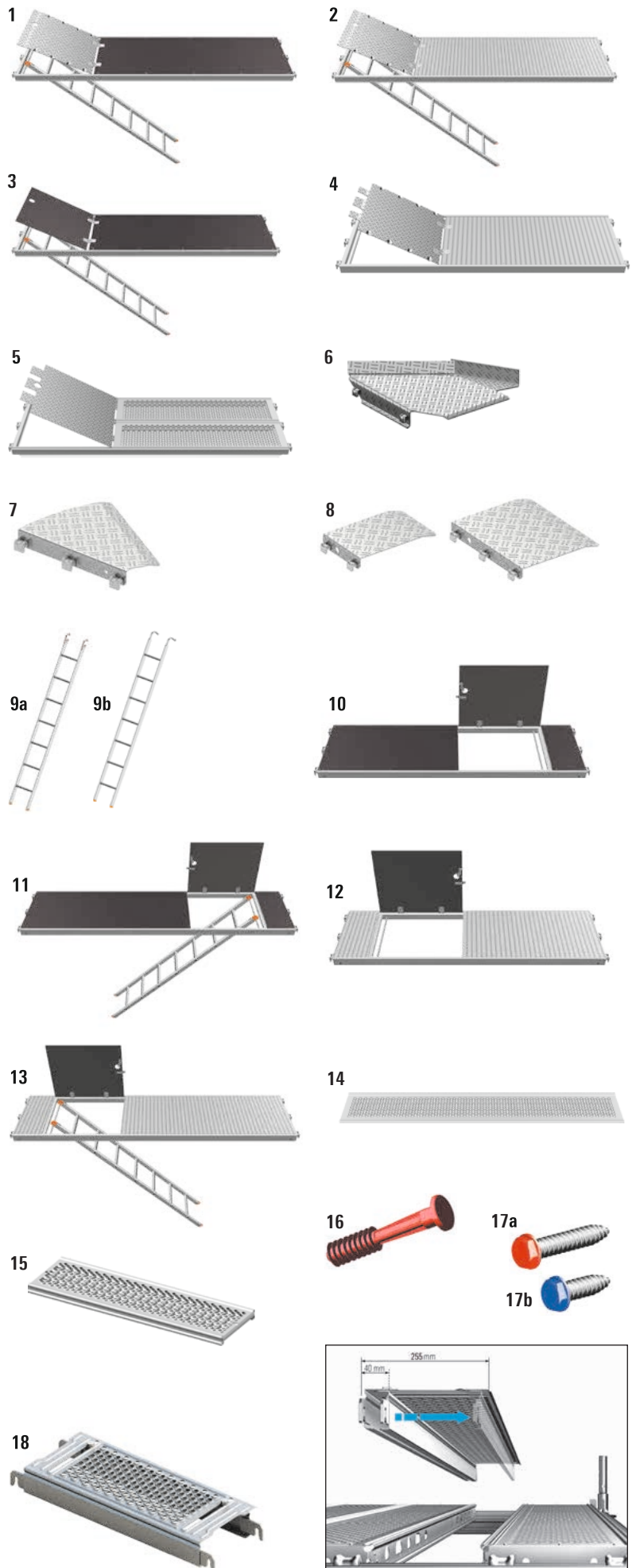

| Pos. | Description | Use to load class | Dimensions L/H x W [m] | Weight approx. [kg] | PU [pcs.] | Ref. No. | |
|------|-----------------------------------------------------------------------------------------------------------------------------------------------------------------|-------------------|---------------------------|------------------------|--------------|----------|-------------------|
| 1 | U-Xtra-N deck, 0.61 m wide, with integrated access ladder Deck surface of glass-fibre-reinforced plastic, aluminium access hatch | IND | 3 | 2.57 x 0.61 | 25.4 | 40 | 3869.257 |
| | | | 3 | 3.07 x 0.61 | 29.5 | 40 | 3869.307 |
| 2 | U-aluminium hatch-type access deck, 0.61 m wide, with integrated access ladder easy access with aluminium deck surface and aluminium access hatch | IND | 3 | 2.57 x 0.61 | 24.0 | 40 | 3852.257 |
| | | | 3 | 3.07 x 0.61 | 28.0 | 40 | 3852.307 |
| 3 | U-robust hatch-type access deck, 0.61 m wide, with integrated access ladder | IND | 3 | 2.57 x 0.61 | 24.0 | 40 | 3838.257 |
| | | | 3 | 3.07 x 0.61 | 27.4 | 40 | 3838.307 |
| 4 | U-aluminium access deck, 0.61 m wide easy access with aluminium deck surface and aluminium access hatch | IND | 3 | 1.57 x 0.61 | 15.1 | 40 | 3851.157 |
| | | | 3 | 2.07 x 0.61 | 17.0 | 40 | 3851.207 |
| | | | 3 | 2.57 x 0.61 | 20.0 | 40 | 3851.257 |
| | | | 3 | 3.07 x 0.61 | 24.5 | 40 | 3851.307 |
| 5 | U-hatch-type steel access deck, 0.64 m wide aluminium access hatch | | 4 | 2.07 x 0.64 | 28.9 | 30 | 3813.207 |
| | | | 4 | 2.57 x 0.64 | 38.0 | 30 | 3813.257 |
| 6 | Corner deck, adjustable for angles from 45° – 90°, with toe board in steel | | 3 | 0.61 | 21.5 | 30 | 3819.000 |
| 7 | U-corner deck for circular scaffolding 30°, steel | | | 0.73 | 8.2 | 120 | 3868.000 |
| | | | | 1.09 | 12.1 | 120 | on request |
| 8 | U-deck for equalisation for steel assembly frames | | | 0.50 x 0.32 | 7.2 | | 3868.032 |
| | | | | 0.50 x 0.61 | 13.8 | | 3868.061 |
| 9a | Access ladder T15 , steel, 7 rungs for Allround Scaffolding System and SpeedyScaf System | | | 2.15 x 0.35 | 7.6 | 70 | 4008.007 |
| 9b | Access ladder , steel, 7 rungs for SpeedyScaf System | | | 2.15 x 0.35 | 7.8 | 70 | 4005.007 |
| 10 | U-robust hatch-type access , 0.61 m, hatch offset without ladder. For use with 4005.007 | IND | 3 | 1.57 x 0.61 | 14.2 | 40 | 3858.157 |
| | | | 3 | 2.07 x 0.61 | 17.2 | 40 | 3858.207 |
| 11 | U-robust hatch-type access , 0.61 m, hatch offset, with integrated access ladder | IND | 3 | 2.57 x 0.61 | 25.2 | 40 | 3859.257 |
| | | | 3 | 3.07 x 0.61 | 28.4 | 40 | 3859.307 |
| 12 | U-aluminium access deck , 0.61 m wide, hatch offset without ladder. For use with 4008.007 | IND | 3 | 2.07 x 0.61 | 17.6 | 40 | 3875.207 |
| 13 | U-aluminium access deck , 0.61 m wide, hatch offset with intergrated access ladder | IND | 3 | 2.57 x 0.61 | 27.0 | 40 | 3875.257 |
| | | | 3 | 3.07 x 0.61 | 31.0 | 40 | 3875.307 |
| 14 | Steel-gap cover, 0.32 m wide Construction height only 10 mm Use up to load class 6 with maximum gap widths of 20 cm | | 6 | 0.73 x 0.32 | 2.6 | 150 | 3881.000 |
| | | | 6 | 1.09 x 0.32 | 3.8 | 150 | 3881.001 |
| | | | 6 | 1.57 x 0.32 | 4.2 | 100 | 3881.002 |
| | | | 6 | 2.07 x 0.32 | 6.3 | 100 | 3881.003 |
| | | | 6 | 2.57 x 0.32 | 8.5 | 100 | 3881.004 |
| | | | 6 | 3.07 x 0.32 | 12.0 | 100 | 3881.005 |
| 15 | Steel plank, 0.30 m completely made of hot-dip galvanized steel | | 6 | 1.00 x 0.30 | 6.5 | 60 | 3880.100 |
| | | | 6 | 1.50 x 0.30 | 10.3 | 60 | 3880.150 |
| | | | 5 | 2.00 x 0.30 | 12.8 | 30 | 3880.200 |
| | | | 3 | 2.50 x 0.30 | 15.3 | 30 | 3880.250 |
| | Steel plank, 0.20 m constructed as 3880 | | 6 | 1.00 x 0.20 | 4.8 | 100 | 3878.100 |
| | | | 6 | 1.50 x 0.20 | 7.2 | 100 | 3878.150 |
| | | | 5 | 2.00 x 0.20 | 9.5 | 100 | 3878.200 |
| | | | 3 | 2.50 x 0.20 | 11.8 | 100 | 3878.250 |
| 16 | Locking pin , plastic, dia. 11 mm | | | | 0.1 | 100 | 3800.006 |
| 17a | Securing screw , long (red), steel hot-dip galvanized For securing of steel planks on steel decks | | WS 19 | 0.08 x 0.03 | 4.0 | 50 | 3800.009 |
| | | | WS 22 | 0.08 x 0.03 | 3.9 | 50 | 3800.010 |
| 17b | Securing screw , short (blue), steel hot-dip galvanized For securing of steel gap covers on steel decks | | WS 19 | 0.04 x 0.02 | 2.3 | 50 | 3800.011 |
| | | | WS 22 | 0.04 x 0.02 | 2.3 | 50 | 3800.012 |
| 18 | Telescopic U-gap deck closes gaps between 40 and 255 mm | | 6 | 0.73 | 5.2 | 40 | 3881.073 |
| | | | 6 | 1.09 | 7.8 | 40 | 3881.109 |
| | | | 6 | 1.40 | 10.1 | 40 | 3881.140 |
| | | | 6 | 1.57 | 11.4 | 40 | 3881.157 |
| | | | 6 | 2.07 | 14.9 | 40 | 3881.207 |
| | | | 5 | 2.57 | 18.6 | 40 | 3881.257 |
| | | | 4 | 3.07 | 22.3 | 40 | 3881.307 |

WS = wrench size PU = packaging unit = available ex works = delivery time on request = only available in this packaging unit = the approval process is not yet completed

IND = Layher Individual possible – see page 7

Side protection

You can choose between **single 1** and **double guardrails 2/3** in steel or double guardrails in aluminium. All guardrails are dropped into the guardrail wedge housings of the assembly frames and engaged on the wedge with a hammer blow to provide a positive and stable connection.

The **end guardrails 4/5** are wedged to the vertical tube with the half-coupler.

The **double end guardrails 6/7** are wedged to the guardrail boxes.

The **adjustable guardrail 8** is suitable for inner and outer corners and for non-system bays. A pivoted guardrail connecting lug is provided.

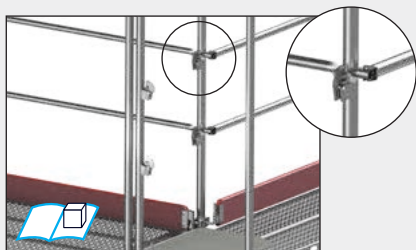

Internal guardrail fixing device 9

Speedy fitting of internal guardrails to the assembly frame LW. Guardrail boxes are attached simply by inserting and then turning them.







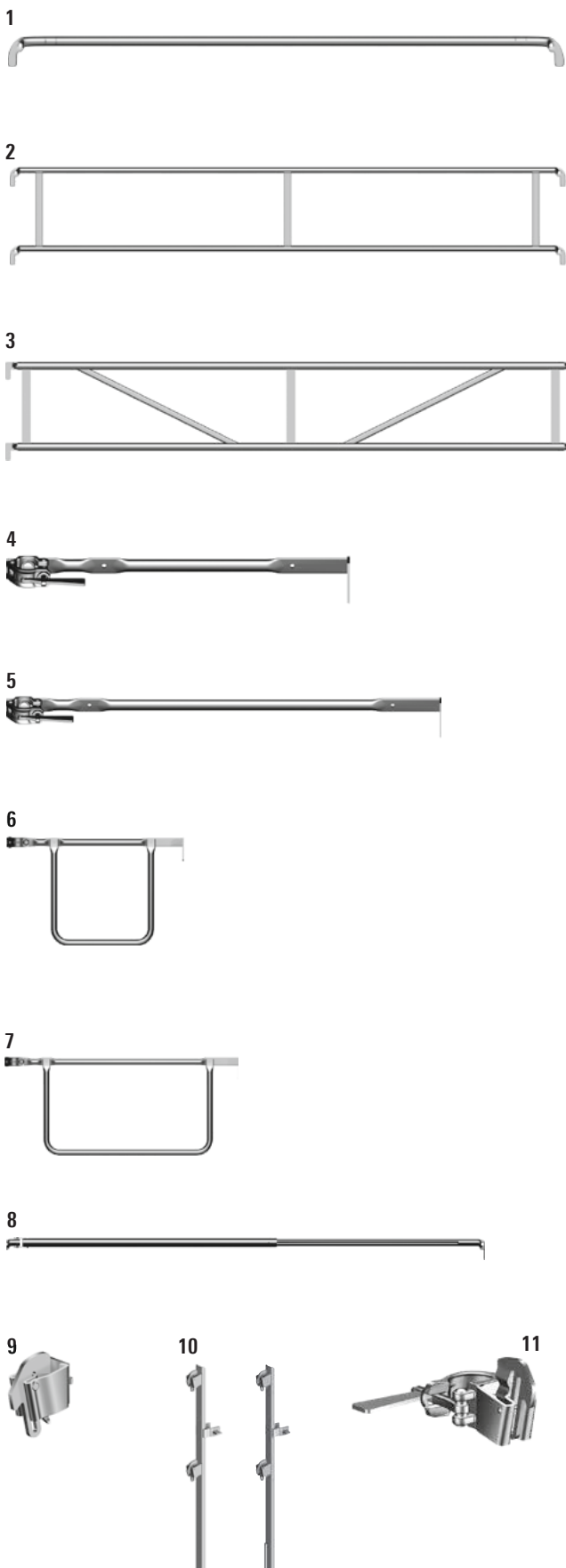

Guardrail box for Speedy frame 10

Quick fixing of internal guardrails (also on older speedy assembly frames) by wedging the U-profile to the assembly frame standard.

Guardrail coupler 11

For connecting guardrails outside the standard dimensions, and also for fitting wall-side guardrails to older assembly fra



| Pos. | Description | Dimensions L/H x W [m] | Weight approx. [kg] | PU [pcs.] | Ref. No. |
|------|----------------------------------------------------------------------------------------------------------------------------------------------------------|---------------------------|------------------------|--------------|-------------------------------------------------------------------------------------------------------|
| 1 | Single guardrail steel | 0.73 | 1.6 | 50 | 1724.073 |
| | | 1.09 | 2.0 | 50 | 1724.109 |
| | | 1.57 | 2.9 | 140 | 1725.157 |
| | | 2.07 | 3.8 | 140 | 1725.207 |
| | | 2.57 | 4.7 | 140 | 1725.257 |
| | | 3.07 | 5.6 | 140 | 1725.307 |
| 2 | Double guardrail steel | 1.57 x 0.50 | 7.9 | 70 | 1728.157 |
| | | 2.07 x 0.50 | 10.5 | 70 | 1728.207 |
| | | 2.57 x 0.50 | 12.4 | 70 | 1728.257 |
| | | 3.07 x 0.50 | 14.1 | 70 | 1728.307 |
| | | 4.14 x 0.50 | 21.0 | 70 | 1728.414  |
| 3 | Double guardrail aluminium | 1.57 x 0.50 | 3.5 | 50 | 1732.157 |
| | | 2.07 x 0.50 | 4.6 | 50 | 1732.207 |
| | | 2.57 x 0.50 | 5.8 | 50 | 1732.257 |
| | | 3.07 x 0.50 | 6.7 | 50 | 1732.307 |
| 4 | Single end guardrail, 0.73 m | 0.73 | 2.2 | 200 | 1725.073 |
| 5 | Single end guardrail, 1.09 m | 1.09 | 3.5 | 200 | 1725.109  |
| 6 | Double end guardrail, 0.73 m | WS 19 0.73 | 4.4 | 100 | 1728.719 |
| | | WS 22 0.73 | 4.4 | 100 | 1728.722 |
| 7 | Double end guardrail, 1.09 m | WS 19 1.09 | 5.6 | 50 | 1728.119 |
| | | WS 22 1.09 | 5.6 | 50 | 1728.122 |
| 8 | Guardrail, adjustable  Adjustment range 1.57 m – 2.57 m | | 6.9 | 50 | 1726.000 |
| 9 | Guardrail box for Speedy frame | | 0.5 | 450 | 1735.100 |
| 10 | Speedy Internal guardrail fixing device without toe board pin  | 1.00 | 3.1 | 160 | 1716.300 |
| | Speedy Internal guardrail fixing device with toe board pin  | 1.00 | 3.3 | 160 | 1716.301  |
| 11 | Guardrail coupler with box | | 1.3 | 450 | 1735.000 |

WS = wrench size PU = packaging unit  = available ex works  = delivery time on request  = only available in this packaging unit  = the approval process is not yet completed

 = Layher Individual possible – see page 7

Side protection

Toe boards 1/2

Easy fitting into the toe board pins, for complete three-part side protection. Wood, reddish-brown in colour.

Individual toe boards

The toe boards can be individually designed in printing and painting.



Half-coupler with toe board pin 3

Toe board connection to inner corners and SpeedyScaf rolling towers, for example.

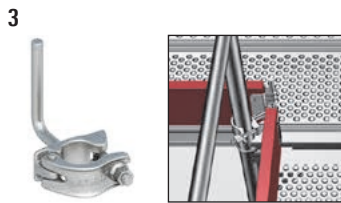

Diagonal bracing

Diagonal braces 4

for vertically bracing the scaffolding parallel and vertical to the facade, tube diametre 42.4 mm.

Diagonal guidance for regular assembly is specified in the approval notification. The diagonal braces are inserted into the corner plate at the top end of the assembly frame. Wedged to the lower diagonal point with the approved wedge half-coupler, they provide an absolutely positive and stable bracing with easy correctability during assembly.

The horizontal strut must be installed in the foot area of the diagonal bay.

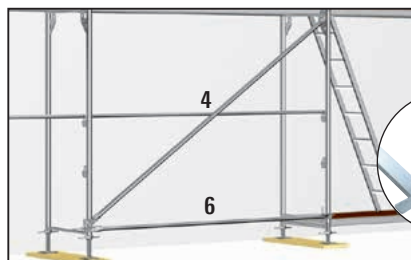
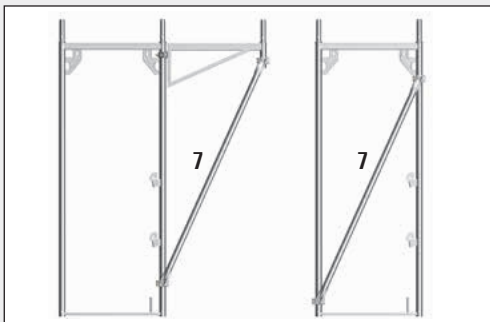

When the cover of the wedge half-coupler is directly underneath the hole marking, the scaffolding bay is vertically aligned.

| Pos. | Description | | Dimensions L / H x W [m] | Weight approx. [kg] | PU [pcs.] | Ref. No. |
|------|-------------------------------------------|-------|-----------------------------|------------------------|--------------|----------------------------------------------------------------------------------------------|
| 1 | Toe board for longitudinal side | IND | 0.73 x 0.15 | 1.6 | 140 | 1756.073 |
| | | | 1.09 x 0.15 | 2.4 | 140 | 1756.109 |
| | | | 1.57 x 0.15 | 3.1 | 140 | 1757.157 |
| | | | 2.07 x 0.15 | 4.7 | 140 | 1757.207 |
| | | | 2.57 x 0.15 | 5.6 | 140 | 1757.257 |
| | | | 3.07 x 0.15 | 6.8 | 140 | 1757.307 |
| | | | 4.14 x 0.15 | 10.3 | 140 | 1757.414 |
| 2 | End toe board for end side | IND | 0.73 x 0.15 | 1.8 | 250 | 1757.073 |
| | | | 1.09 x 0.15 | 2.3 | 140 | 1757.109  |
| 3 | Half-coupler with toe board pin | WS 19 | | 1.0 | 450 | 4708.019 |
| | | WS 22 | | 1.0 | 450 | 4708.022 |

| Pos. | Description | | Dimensions L / H x W [m] | Weight approx. [kg] | PU [pcs.] | Ref. No. |
|------|-------------------------------------------------------------------------------------------------------------------------------------------------------------------------------------------------------------------------------|-------|-----------------------------|------------------------|--------------|------------------------------------------------------------------------------------------------|
| 4 | Diagonal brace with wedge half-coupler for 2.07 m bay length, 2.00 m bay height for 2.57 m bay length, 2.00 m bay height for 3.07 m bay length, 2.00 m bay height for 2.57 m bay length, 1.50 m bay height | | 2.80 | 7.0 | 50 | 1736.207 |
| | | | 3.20 | 7.8 | 50 | 1736.257 |
| | | | 3.60 | 8.3 | 50 | 1736.307 |
| | | | 2.97 | 7.3 | 50 | 1737.257  |
| 5 | Diagonal brace with 2 half-couplers for 1.57 m bay length, 2.00 m bay height | WS 19 | 2.25 | 6.5 | 50 | 1736.157 |
| 6 | Base ledger with 2 wedge half-couplers for 2.07 m bay length for 2.57 m bay length for 3.07 m bay length | | 2.07 | 6.9 | 50 | 1727.207 |
| | | | 2.57 | 8.6 | 50 | 1727.257 |
| | | | 3.07 | 10.4 | 50 | 1727.307 |
| 7 | Section brace with 2 half-couplers for supporting the bracket 0.73 m and in assembly frame 0.73 m | WS 19 | 1.80 | 6.0 | 50 | 1740.177 |
| | | WS 22 | 1.80 | 6.0 | 50 | 1741.177 |
| | for supporting the bracket 1.09 m and in assembly frame 1.09 m | WS 19 | 1.95 | 6.4 | 50 | 1740.195 |
| | | WS 22 | 1.95 | 6.4 | 50 | 1741.195 |

WS = wrench size PU = packaging unit  = available ex works  = delivery time on request  = only available in this packaging unit  = the approval process is not yet completed

IND = Layher Individual possible – see page 7

Brackets

SpeedyScaf can be quickly widened inwards or outwards: the **console brackets** are secured with the welded-on half-coupler in the corner plate of the assembly frame to form a deck level with the main scaffolding.

The **combi-brackets 3** allow the use of **plug-in console brackets 5/6** on a console bracket, if a scaffolding width 0.90 m is necessary or if offsets of the building must be adjusted.

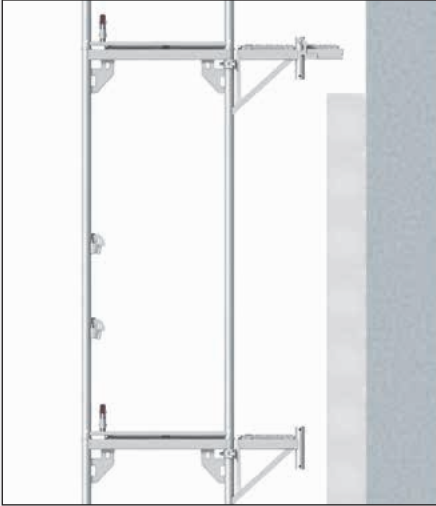

The **plug-in console bracket 0.22 m 5** and **0.36 m 6** is used for quick modifications while building construction, when external thermal insulation compound systems will be fitted to the façade. Thus the required maximum distance between scaffolding and façade is ensured any time, without using internal guardrails. It is only fitted into the locking pin hole. There's no need for alignment or screwing. The plug-in console bracket cannot be used in combination with roof guard supports.

The **console bracket, 0.50 m 7** is used to lengthen or shorten scaffolding bays. When used for widening on the 0.73 m assembly frame, two **decks, 0.61 m** can be installed without gaps.

The **console bracket, 0.73 m 8** may only be installed with a bracket support (**section brace**) (page 24).

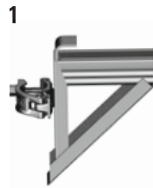

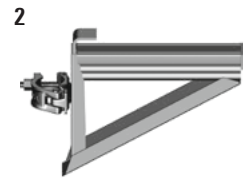

The **console bracket, 0.22 m** for decks, 0.19 m



The **console bracket, 0.36 m** for decks, 0.32 m



| Pos. | Description | | Dimensions L/H x W [m] | Weight approx. [kg] | PU [pcs.] | Ref. No. |
|------|----------------------------------------------------------------------------------------------------------------|-------|---------------------------|------------------------|--------------|-----------------------------------------------------------------------------------------------------|
| 1 | Console bracket, 0.22 m without spigot with integrated lift-off preventer | WS 19 | 0.22 | 2.8 | 100 | 1744.019 |
| | | WS 22 | 0.22 | 2.8 | 100 | 1744.022 |
| 2 | Console bracket, 0.36 m without spigot with integrated lift-off preventer | WS 19 | 0.36 | 3.3 | 125 | 1743.319 |
| | | WS 22 | 0.36 | 3.3 | 125 | 1743.322 |
| 3 | Combi-bracket, 0.36 m  | WS 19 | 0.36 | 4.8 | 100 | 1746.319  |
| | | WS 22 | 0.36 | 4.8 | 100 | 1746.322  |
| 4 | Console bracket, 0.36 m with integrated lift-off preventer | WS 19 | 0.36 | 3.5 | 125 | 1745.319 |
| | | WS 22 | 0.36 | 3.5 | 125 | 1745.322 |
| 5 | Plug-in console bracket, 0.22 m without spigot | | 0.22 | 1.3 | 250 | 1746.022 |
| 6 | Plug-in console bracket, 0.36 m without spigot | | 0.36 | 1.6 | 250 | 1746.036 |
| 7 | Console bracket, 0.50 m | WS 19 | 0.50 | 5.8 | 50 | 1744.519 |
| | | WS 22 | 0.50 | 5.8 | 50 | 1744.522 |
| 8 | Console bracket, 0.73 m | WS 19 | 0.73 | 6.4 | 100 | 1744.719 |
| | | WS 22 | 0.73 | 6.4 | 100 | 1744.722 |

WS = wrench size PU = packaging unit  = available ex works  = delivery time on request  = only available in this packaging unit  = the approval process is not yet completed

IND = Layher Individual possible – see page 7

Brackets

The **console bracket, 0.73 m, swivelling 1** is placed on the spigot of the assembly frame and can be swung clear after removal of the deck. A further advantage is its use for corner solutions, since a 0.73 m bracket can be fitted at the same height. It may also only be used with a bracket support.

The **console bracket, 0.73 m, reinforced 2** can be used in SpeedyScaf 70 in steel up to 3.07 m bay length (up to load class 3) and in brick guards. In this case, it is possible to dispense with the bracket support with SpeedyScaf 70 in steel. The advantages of the **console bracket, 0.73 m, reinforced 2:**

- ▶ No need for section brace
- ▶ Less material needed
- ▶ Lower overall costs
- ▶ Coupler connection to frame possible at bracket level

The **console bracket, 1.09 m 3** may only be installed with a bracket support (**section brace 6**).

The **eaves bracket, 1.00 m 4** meets workplace requirements for painters, plasterers, plumbers and roofers. It obviates the need for structures requiring much time and material. The deck in the main scaffolding must be secured using the lift-off preventer. The toe board can be suspended in the eaves bracket.

Bracket decks too must be secured against inadvertent lifting off, therefore either the single guardrail support or the **lock against lift-off 5** is essential. The lift-off preventer is secured by means of locking pins.

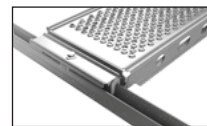
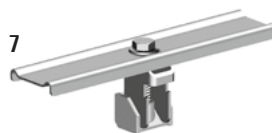
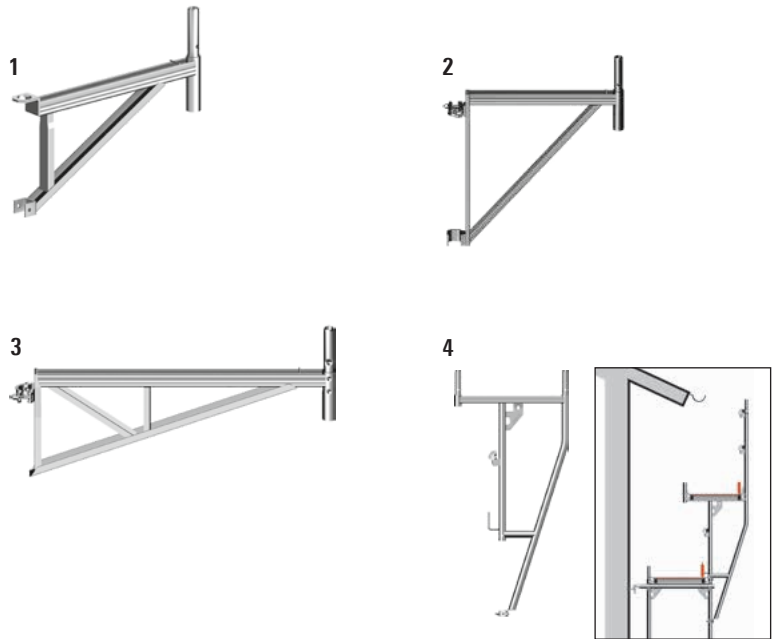

Securing of one deck

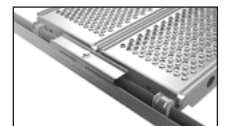

Securing of two decks

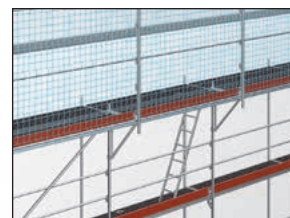

| Pos. | Description | | Dimensions L/H x W [m] | Weight approx. [kg] | PU [pcs.] | Ref. No. |
|------|------------------------------------------------------------------------------------------------------------------------------------------|-------|---------------------------|------------------------|--------------|-----------------|
| 1 | Console bracket, 0.73 m, swivelling | | 0.73 | 7.0 | 80 | 1744.073 |
| 2 | Console bracket, 0.73 m, reinforced | WS 19 | 0.73 | 8.8 | 40 | 1745.719 |
| | | WS 22 | 0.73 | 8.8 | 40 | 1745.722 |
| 3 | Console bracket, 1.09 m | WS 19 | 1.09 | 9.6 | 30 | 1745.119 |
| | | WS 22 | 1.09 | 9.6 | 30 | 1745.122 |
| 4 | Eaves bracket, 1.00 m steel, hot-dip galvanized | | 1.00 x 0.73 | 14.8 | 50 | 1718.100 |
| 5 | Lock against lift-off for bracket 0.36 m wide for bracket 0.50 m wide for bracket 0.73 m wide for bracket 1.09 m wide | | 0.36 | 0.9 | 250 | 1743.036 |
| | | | 0.50 | 1.3 | 250 | 1743.050 |
| | | | 0.73 | 1.5 | 500 | 1743.073 |
| | | | 1.09 | 2.3 | 50 | 1743.109 |
| 6 | Section brace with 2 half-couplers for supporting the bracket 0.73 m | WS 19 | 1.80 | 6.0 | 50 | 1740.177 |
| | | WS 22 | 1.80 | 6.0 | 50 | 1741.177 |
| | for supporting the bracket 1.09 m | WS 19 | 1.95 | 6.4 | 50 | 1740.195 |
| | | WS 22 | 1.95 | 6.4 | 50 | 1741.195 |
| 7 | Universal U-Lift-off preventer | WS 19 | | 1.0 | 500 | 2635.000 |

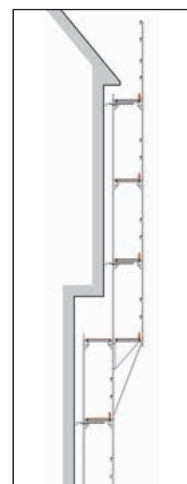
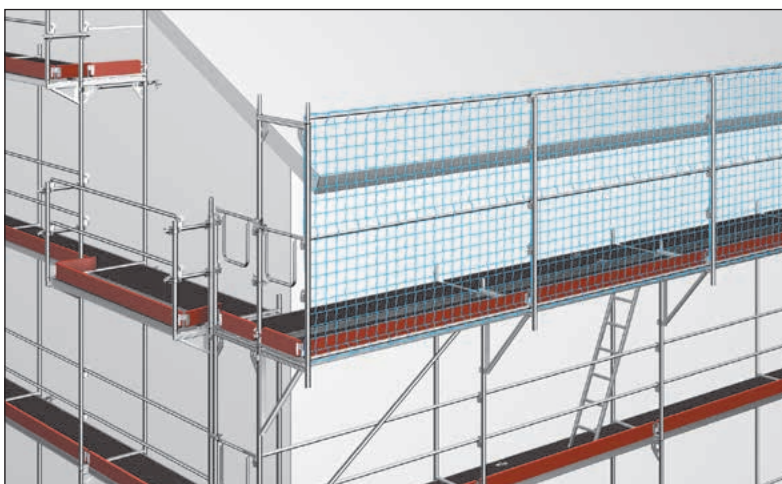

The maximum assembly height on brackets is dependent on the decks, bay lengths and assembly frames used. The appropriate structural strength specifications must be observed. Further information can be found in our SpeedyScaf Technical Brochure.

WS = wrench size PU = packaging unit = available ex works = delivery time on request = only available in this packaging unit = the approval process is not yet completed

IND = Layher Individual possible – see page 7



Anchoring

The scaffolding must be anchored vertically to and parallel with the façade with resistance to both tensile and compressive stress. Layher offers speedy and safe solutions:

- ▶ **The SpeedyScaf wall tie 1**, which is fastened with a **double coupler** in the corner plate of the assembly frame and is supported with the fork plate on the channel section of the assembly frame.
- ▶ **The wall tie 2**, which is connected with two double or corner plate couplers to both upright tubes.
- ▶ **SpeedyScaf corner plate coupler 3**
For outside and inside brackets too, continuous anchoring directly on the corner plate of the **assembly frame LW** is possible and ensures a greater height clearance.

The anchoring forces in accordance with the approval or individual verification of structural strength can vary widely. The loading capacity of the anchoring, in particular of the anchoring foundation, must be carefully checked and verified (see instructions for assembly and use).

For double couplers see page 38. For insert testing instrument see catalogue System-free Accessories.

The **ETICS-tie** is constructed for carrying high loads, parallel to the façade, in use together with external thermal insulation compound systems.

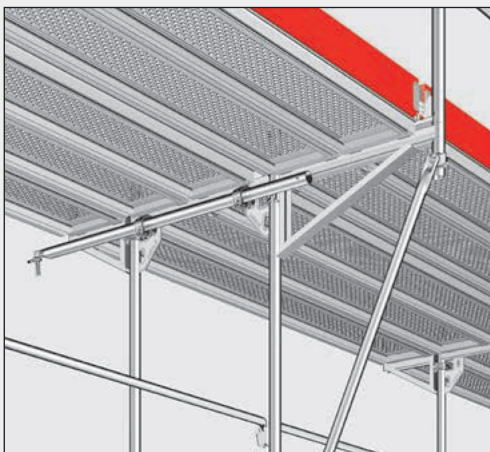
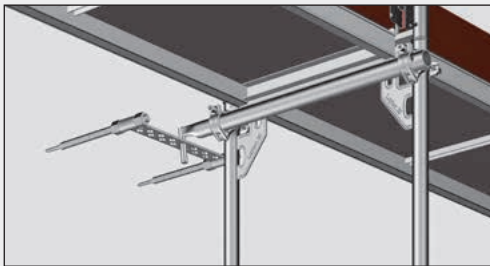

Wall tie with two plate couplers



SpeedyScaf wall tie with double coupler



2 wall ties connected in a V-shape with one double coupler each to the inner standard.

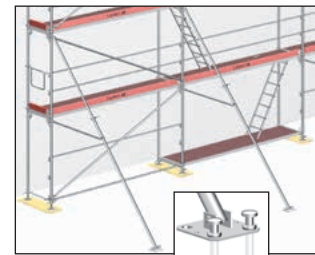
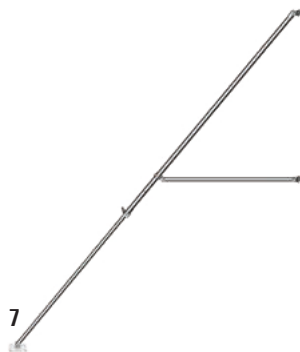

10

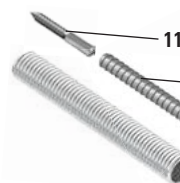

11



12



13



Cross-piece 600 resp. cross-piece 800

15



14

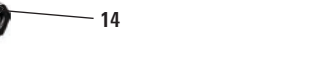

| Pos. | Description | Dimensions L/H x W [m] | Weight approx. [kg] | PU [pcs.] | Ref. No. |
|------|-----------------------------------------------------------------------------------------------------------------|---------------------------|------------------------|--------------|----------|
| 1 | SpeedyScaf wall tie | 0.69 | 2.8 | 100 | 1755.069 |
| 2 | Wall tie | 0.38 | 1.6 | 250 | 1754.038 |
| | | 0.69 | 2.8 | 50 | 1754.069 |
| | | 0.95 | 3.7 | 50 | 1754.095 |
| | | 1.45 | 5.7 | 50 | 1754.145 |
| | | 1.75 | 5.8 | 50 | 1754.175 |
| 3 | Gusset coupler | WS 19 | 0.9 | 450 | 1735.019 |
| 4 | Plastic wall insert, plastic drilled hole dia. 14 mm | 70 mm | 0.3 | 25 | 4008.071 |
| | | 100 mm | 0.3 | 25 | 4008.101 |
| | | 135 mm | 0.3 | 25 | 4008.136 |
| 5 | Ring screw, steel, galvanized, dia. 12 mm, for expanding plug | 95 mm | 1.6 | 10 | 4009.096 |
| | | 120 mm | 1.8 | 10 | 4009.121 |
| | | 190 mm | 2.5 | 10 | 4009.191 |
| | | 230 mm | 3.0 | 10 | 4009.231 |
| | | 300 mm | 3.5 | 10 | 4009.301 |
| | | 350 mm | 5.0 | 10 | 4009.351 |
| 6 | Cap, 12 mm, white, for expanding plug Ref. No. 4008 | 12 mm | 1.0 | 100 | 4007.006 |
| 7 | Telescopic stabilizer, steel, 3.30 – 6.00 m | 3.30 | 28.4 | 20 | 4032.600 |
| 8 | Peg solid, dia. 24 mm | 470 mm | 1.8 | 500 | 4032.100 |
| 9 | Peg extraction device | | 8.0 | 40 | 4032.200 |
| 10 | ETICS-tie 600 complete, up to approx. 200 mm insulation | 0.68 | 5.5 | 180 | 4000.600 |
| | ETICS-tie 800 complete, up to approx. 300 mm insulation comprising items 11, 12 (2 x), 13 (2 x) and 15 (4 x) | 0.88 | 6.9 | 120 | 4000.800 |
| 11 | ETICS hanger bolt, M12 x 125 | 125 mm | 2.0 | 25 | 4000.126 |
| 12 | ETICS-tie rod 380, up to approx. 200 mm insulation | 0.38 | 10.0 | 10 | 4000.121 |
| | ETICS-tie rod 480, up to approx. 300 mm insulation | 0.48 | 13.0 | 10 | 4000.481 |
| 13 | Plastic pipe, 50 m | | 5.0 | | 4000.050 |
| 14 | Lock nut, WS 36 x 30 | | 4.0 | 20 | 2671.131 |
| 15 | Open ended wrench, WS 36 | | 0.5 | 5 | 2671.135 |

WS = wrench size PU = packaging unit = available ex works = delivery time on request = only available in this packaging unit = the approval process is not yet completed

= Layher Individual possible – see page 7

Standard brick guard, pedestrian protection, guardrail closure

Roofer's guard system

The heightened side protection specified for roofing work is swiftly assembled in SpeedyScaf scaffolding: at the top level, attach the **brick guard support 1** instead of a guardrail support, drop in two brick guards for each bay (locking element determines how they are installed), knock in wedges, insert toe boards and locking pins – done!

Speedy assembly frames LW are used to close off roofer's guard system levels at the ends.

Side protection net 6/7

The nets are attached at the bottom (at scaffolding deck height) and at the top (2 m above the scaffolding deck) to a tube



With quick strap fasteners, the protection net is attached to the tubes at every 750 mm. A toe board and a handrail are required in any event.

Protection net 10.00 x 2.00 m, specification: Mesh width 100 mm, blue, made of PPM 4.5 mm, knotless, as per DIN EN 1263-1, type U

Fan support 9

Protection against falling objects. The surfaces must be covered with system decks. Two decks 0.61 m wide are dropped in horizontally, and one deck 0.61 m and one deck 0.32 m at an angle.

Guardrail closure, top

Speedy intermediate frames 10 with welded-on wedge housings secure the top work deck. Guardrails are dropped in and wedged as on the assembly frame.

The **top end frames 11** for securing the scaffolding end sides are already provided using end guardrails. Only the toe board still has to be fitted.

Alternatively, it is possible to use 1.00 m high assembly frames with guardrail wedge housings on the end side. An end guardrail acting as a knee rail is also required here. For fastening reasons, only **double guardrails** can then be installed on the longitudinal side. One guardrail lug of the hand rail is inserted into the channel section of the assembly frame on the end side. The other three guardrail lugs are wedged as usual. Securing of the top scaffolding level with **locking pins** is recommended (see page 12).

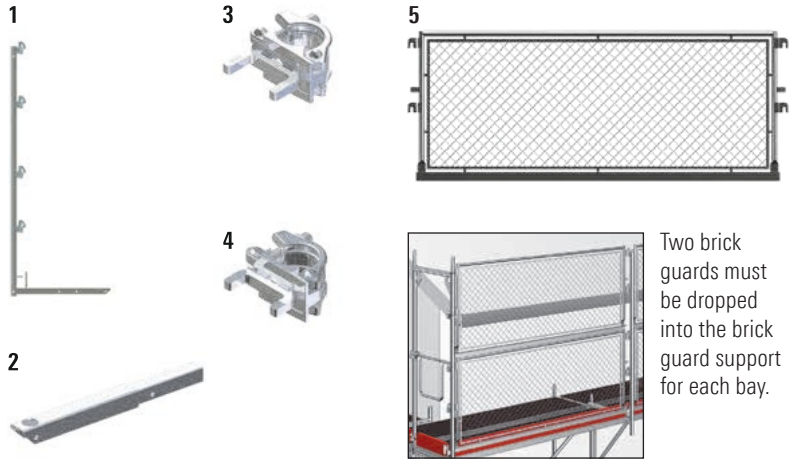



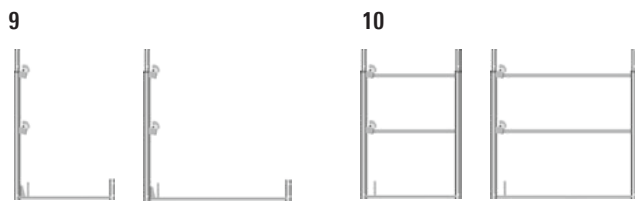
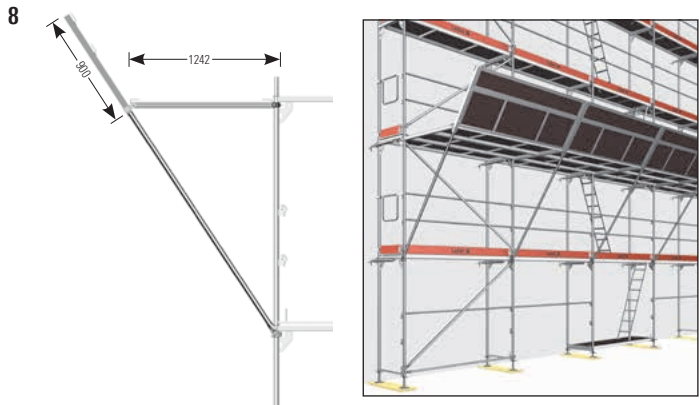
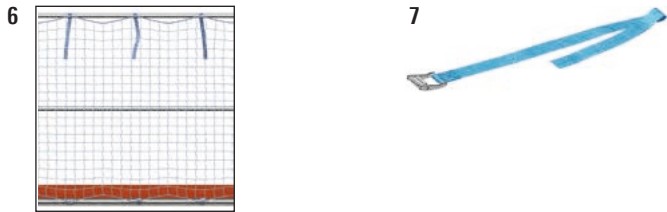



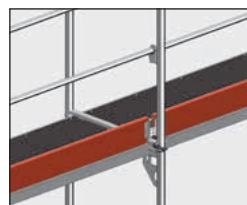













Two brick guards must be dropped into the brick guard support for each bay.



The **guardrail post** is used for 0.36 m brackets. The guardrail is closed at the end sides with tubes and couplers. An end toe board must be fitted by the customer.



By using the **scaffolding lock**, you can secure your scaffolding against unauthorized alteration or dismantling. Use in topmost level instead of locking pins.

| Pos. | Description | Dimensions L/H x W [m] | Weight approx. [kg] | PU [pcs.] | Ref. No. |
|------|----------------------------------------------------------------------------------------------------------------------------------------------------------------------------------------------------------------------------------|---------------------------|------------------------|------------------------------------------------------------------------------------------|------------------------------------------------------------------------------------------------|
| 1 | Brick guard support, 0.36/0.50/0.73 m (Use on Speedy frames LW 0.73 m and brackets 0.36 m, 0.50 m and 0.73 m) | 2.00 x 0.73 | 12.1 | 20 | 1748.003 |
| 2 | Adapter for brick guard support  for use with bay width of 1.09 m | 0.68 | 2.3 | 200 | 1748.002  |
| 3 | Double-pin coupler SGS for brick guard support for combining the new and old variants | WS 19 | 0.9 | 450 | 4702.219 |
| | | WS 22 | 0.9 | 450 | 4702.222 |
| 4 | Double-pin coupler SR for Speedy assembly frames for use at end of bay | WS 19 | 0.9 | 450 | 4702.319 |
| | | WS 22 | 0.9 | 450 | 4702.322 |
| 5 | SpeedyScaf roof guard | 1.00 x 1.57 | 15.5 | 30 | 1749.157  |
| | | 1.00 x 2.07 | 17.7 | 30 | 1749.207  |
| | | 1.00 x 2.57 | 21.1 | 30 | 1749.257  |
| | | 1.00 x 3.07 | 24.4 | 30 | 1749.307  |
| 6 | Protection net without quick belt | 10.00 x 2.00 | 5.9 | 40 | 6232.002 |
| 7 | Quick belt | 0.50 | 1.5 | 50  | 6235.001 |
| 8 | Fan support | 2.10 | 18.9 | 20 | 1773.019  |
| 9 | Speedy intermediate frame, 0.73 m, steel Speedy intermediate frame, 0.73 m, aluminium, without spigot Speedy intermediate frame, 1.09 m, steel | 1.00 x 0.73 | 6.5 | 50 | 1719.073 |
| | | 1.00 x 0.73 | 2.7 | 50 | 1769.073 |
| | | 1.00 x 1.09 | 8.5 | 50 | 1719.109  |
| 10 | Speedy intermediate frame, 0.73 m, steel Speedy intermediate frame, 0.73 m, aluminium, without spigot Speedy top end frame, 1.09 m, steel | 1.00 x 0.73 | 13.3 | 50 | 1722.073 |
| | | 1.00 x 0.73 | 4.6 | 25 | 1770.073 |
| | | 1.00 x 1.09 | 14.9 | 50 | 1722.109  |
| 11 | Speedy guardrail post, single, with guardrail wedge head housing, for bracket 0.36 m wide in steel in aluminium | 1.00 | 5.5 | 100 | 1716.000 |
| | | 1.00 | 2.4 | 100 | 1768.000 |
| 12 | Scaffolding lock basic set, 2 keys and code card basic set, 2 keys and code card basic set, 4 keys and code card Expansion set with same locking as basic set Expansion set with same locking as basic set | | 2.20 | 10  | 4000.003  |
| | | | 4.20 | 20  | 4000.004  |
| | | | 10.50 | 50  | 4000.005  |
| | | | 4.20 | 20  | 4000.006  |
| | | | 10.50 | 50  | 4000.007  |

WS = wrench size PU = packaging unit  = available ex works  = delivery time on request  = only available in this packaging unit  = the approval process is not yet completed

 = Layher Individual possible – see page 7

Stair access

Scaffolding access, outside

The **Aluminium platform stairs 2** offers increased safety, convenience and speed when ascending the tower. Material transport is facilitated by the additional use of the work decks as allround walkways. The platform stair is covered by the approval in its regular version (up to 24 m).

The platform stairtower will be connected to the work scaffolding using the **U-distance coupler 6**. The 0.19 m wide "gap-deck" bears in the U-profile of the coupler. Alternatively the stairtower can be connected directly to work scaffolding. The gap will be closed using the **telescopic gap deck** (see page 16).

Starter U-transom for 4:

- ▶ Scaffolding access with platform stairs, at the entrance for dropping into the stair;
- ▶ Ladder access to the 0.73 m wide scaffolding, accommodates at the lowest level of an access bay the deck that may be required for setting up the ladder.

The **Comfort stair 3** bases on the platform stair and has reinforced stringers and step sections. The 175 mm wide grooved steps guarantee more comfort when ascending the stairs, especially for high stair heights. Guardrails, internal guardrails and stairwell guardrail can be used from the platform stair.

Outer platform stair access

(stairs in identical direction)

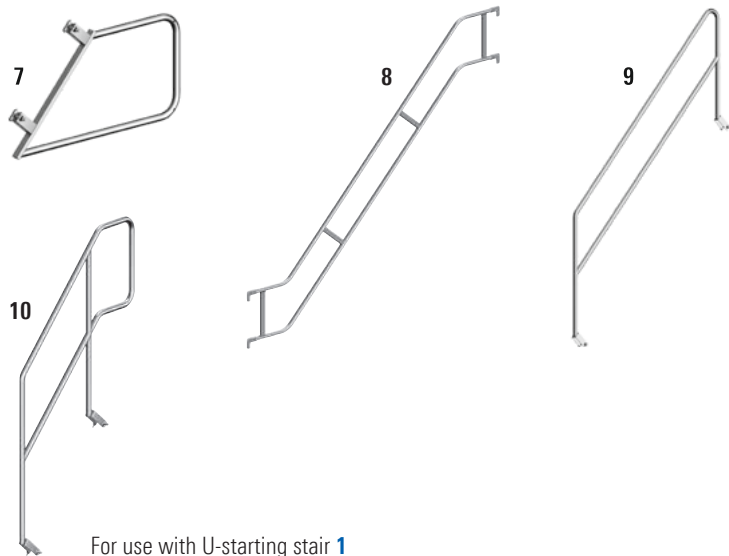
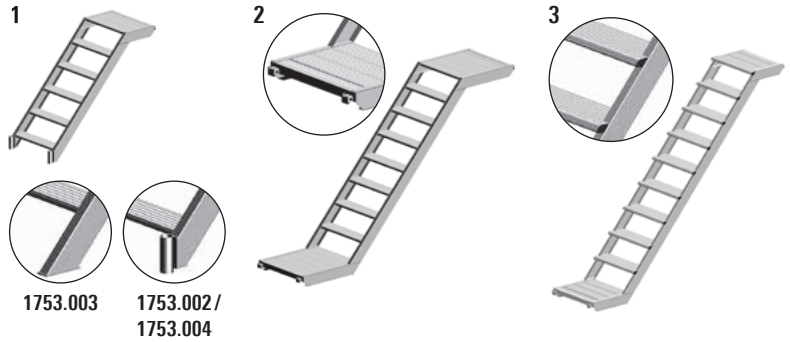

Modular stair

With the **modular stair**, accesses that always fit and that match the system can be constructed. Any intermediate dimension can be achieved simply by fitting together the individual stair parts. The stair rises 20 cm from step to step, and the bottom element with spindles is used for precise levelling. A wide variety of applications thanks to modular design. Little space needed for transport and assembly.



Height differences from 0.60 m to 1.60 m can be bridged. Load-bearing capacity: 3.0 kN/m². Design: steel, hot-dip galvanized. Connection of elements with bolt, dia. 12 x 55 mm and safety clip 2.8 mm (2 per joint). They are already included in the scope of delivery.

| Pos. | Description | | Dimensions L/H x W [m] | Weight approx. [kg] | PU [pcs.] | Ref. No. |
|------|-------------------------------------------------------------------------------------------------------------------------------------------------------------------------------------------------------------------------------------------------------------------------------------------------------------|-------|---------------------------|------------------------|--------------|-----------------|
| 1 | U-starting stair, 0.64 m wide, aluminium 1.00 m high, Load-bearing cap. 2.5 kN/m ² ; Step height 0.20 m 1.20 m high, Load-bearing cap. 2.5 kN/m ² ; Step height 0.20 m 1.70 m high, Load-bearing cap. 2.5 kN/m ² ; Step height 0.19 m | | 1.00 x 0.64 | 11.5 | 10 | 1753.003 |
| | | | 1.20 x 0.64 | 13.5 | 10 | 1753.002 |
| | | | 1.70 x 0.64 | 18.3 | 10 | 1753.004 |
| 2 | U-platform stair, 0.64 m wide, aluminium Load-bearing cap. 2.5 kN/m ² , Stair class A acc. to EN 12811-1 for 2.57 m bay length, Step height 0.20 m, 2.00 m high for 3.07 m bay length, Step height 0.20 m, 2.00 m high for 2.57 m bay length, Step height 0.20 m, 1.50 m high | | 2.57 x 0.64 | 21.9 | 10 | 1753.257 |
| | | | 3.07 x 0.64 | 26.3 | 10 | 1753.307 |
| | | | 2.57 x 0.64 | 21.5 | 10 | 1753.251 |
| 3 | U-comfort stair, 0.64 m wide, aluminium Load-bearing cap. 2.5 kN/m ² , Stair class B acc. to EN 12811-1 for 2.57 m bay length, Step height 0.22 m, 2.00 m high for 3.07 m bay length, Step height 0.22 m, 2.00 m high | | 2.57 x 0.64 | 27.0 | 10 | 1755.257 |
| | | | 3.07 x 0.64 | 32.0 | 10 | 1755.307 |
| 4 | Starter U-transom | | 0.73 | 3.8 | 42 | 1751.073 |
| | | | 1.09 | 5.1 | 42 | 1751.109 |
| 5 | Stair-guardrail post for stairwell at the top level | WS 19 | 1.10 | 5.1 | 50 | 1752.006 |
| 6 | U-distance coupler for connecting stairtower to the work scaffolding | WS 19 | | 2.0 | 250 | 1752.019 |
| | | WS 22 | | 2.0 | 250 | 1752.022 |
| 7 | Stairwell guardrail | WS 19 | | 6.2 | 40 | 1752.004 |
| | | WS 22 | | 6.2 | 40 | 1752.014 |
| 8 | Stair guardrail for 2.57 m bay length, 2.00 m bay height for 3.07 m bay length, 2.00 m bay height for 2.57 m bay length, 1.50 m bay height | | 2.57 x 2.00 | 16.1 | 30 | 1752.257 |
| | | | 3.07 x 2.00 | 17.6 | 30 | 1752.307 |
| | | | 2.57 x 1.50 | 14.6 | 30 | 1752.003 |
| 9 | Stair guardrail for 2.57 m bay length, 2.00 m bay height for 3.07 m bay length, 2.00 m bay height for 2.57 m bay length, 1.50 m bay height Mandatory for opposite-direction stairs | WS 19 | 2.00 | 13.5 | 20 | 1752.007 |
| | | WS 22 | 2.00 | 13.5 | 20 | 1752.008 |
| | | WS 19 | 1.50 | 11.5 | 20 | 1752.012 |
| | Internal guardrail for U-starting stair | WS 19 | 1.00 | 7.8 | 20 | 1752.011 |
| 10 | Initial stair guardrail | WS 19 | 0.90 x 1.70 m | 9.9 | 20 | 1752.009 |
| | | WS 22 | 0.90 x 1.70 m | 9.9 | 20 | 1752.013 |

| Pos. | Description | | Dimensions L/H x W [m] | Weight approx. [kg] | PU [pcs.] | Ref. No. |
|------|----------------------------------------------------------------------------|--|---------------------------|------------------------|--------------|-----------------|
| 11 | Stair foot section, 0.60 m Stair foot section, 0.95 m | | 0.60 | 6.8 | 15 | 2639.060 |
| | | | 0.95 | 7.8 | 50 | 2639.095 |
| 12 | Stair middle section, 0.60 m Stair middle section, 0.95 m | | 0.60 | 9.2 | 15 | 2638.060 |
| | | | 0.95 | 10.2 | 50 | 2638.095 |
| 13 | Stair head section, 0.60 m Stair head section, 0.95 m | | 0.60 | 10.7 | 15 | 2637.060 |
| | | | 0.95 | 11.7 | 50 | 2637.095 |

WS = wrench size PU = packaging unit = available ex works = delivery time on request = only available in this packaging unit = the approval process is not yet completed

= Layher Individual possible – see page 7

System lattice beam

SpeedyScaf lattice beam LW 1

The top chord with engagement lugs at both ends and spigots for further construction in the standard dimension is dropped into the spigots of the assembly frame, while the bottom chord must be connected with **lattice beam couplers 2** to the upright tube. The use of the SpeedyScaf lattice beams is governed by the approval notification, which must be complied with. If the aluminium SpeedyScaf lattice beam is used, bear in mind the reduced load-bearing capacities! For bridging of up to 4.14 m distances with steel or aluminium decks in the standard SpeedyScaf assembly.

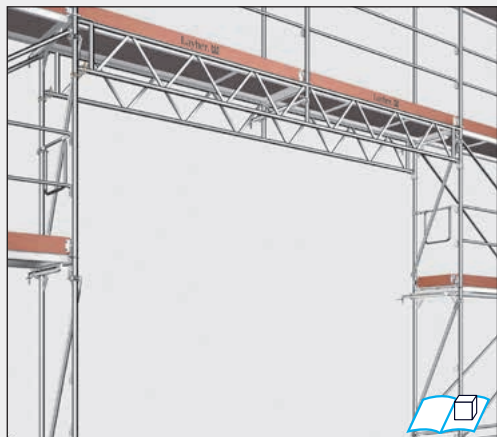

Example: SpeedyScaf lattice beam 5.14 m, covered scaffolding (special diagonal guidance)

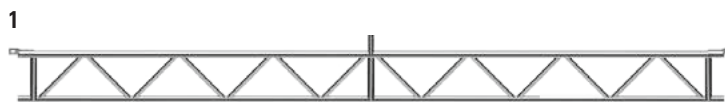

Use of the lattice beam coupler

3a/b



For accommodating scaffolding decks when bridging with SpeedyScaf lattice beams

4



5



When placed on non-system lattice beams for bridging, it is also possible to continue construction in the standard system dimensions with 0.73 m wide assembly frames.

6

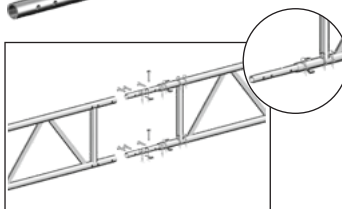

7



Further lattice beams you'll find in the catalogue System-free Accessories.



Scaffolding barriers

In accordance with the German RSA guidelines for safeguarding work areas on roads, scaffolding must be provided with clearly visible barriers to separate it from public traffic routes such as walkways and cycle paths. Depending on local conditions, a reduced headroom – for example in pedestrian tunnels underneath scaffolding – may make a passageway marking necessary. To meet the requirements as set forth in RSA (Part A) for securing scaffolding and pedestrian walkways, Layher has designed for SpeedyScaf quick-to-fit components, made of steel and with red / white retro-reflecting film of reflection class RA 2. They are simply suspended from the guardrail wedge housings of the SpeedyScaf assembly frame. **Passageway markings with half-couplers 10** are available for fitting at the ends.

Thanks to the galvanised surfaces of the components, they also offer a persuasive combination of long life and reusability.

8 and 9a/b

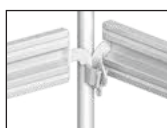

10

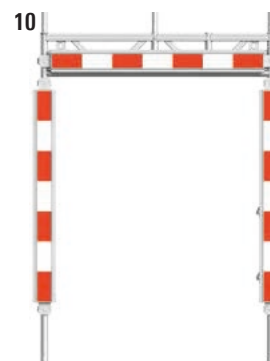

| Pos. | Description | Dimensions L/H x W [m] | Weight approx. [kg] | PU [pcs.] | Ref. No. |
|------|-----------------------------------------------------------------------------------------------------------------------------------------------|---------------------------|------------------------|--------------|-----------------|
| 1 | SpeedyScaf lattice beam LW, steel 5.14 m (2 x 2.57 m bay) 6.14 m (2 x 3.07 m bay) 7.71 m (3 x 2.57 m bay) | 5.14 x 0.45 | 46.4 | 20 | 1781.514 |
| | | 6.14 x 0.45 | 53.9 | 20 | 1781.614 |
| | | 7.71 x 0.45 | 67.2 | 20 | 1781.771 |
| | SpeedyScaf lattice beam, aluminium 5.14 m (2 x 2.57 m bay) 6.14 m (2 x 3.07 m bay) | 5.14 x 0.45 | 22.5 | 20 | 1767.514 |
| | | 6.14 x 0.45 | 26.4 | 20 | 1767.614 |
| | | | | | |
| 2 | Lattice beam coupler for SpeedyScaf lattice beam | WS 19 | 1.6 | 450 | 4720.019 |
| | | WS 22 | 1.6 | 450 | 4720.022 |
| 3 | U-ledger for lattice beam for accommodating scaffolding decks when bridging with SpeedyScaf lattice beams a) 0.73 m b) 1.09 m | | | | |
| | | 0.73 | 3.1 | 42 | 4923.073 |
| | | 1.09 | 7.8 | 42 | 4923.109 |
| 4 | Steel lattice beam 450 LW, 45 cm high 2.25 m long 3.25 m long 4.25 m long 5.25 m long 6.25 m long | 2.25 x 0.45 | 21.8 | 40 | 4925.225 |
| | | 3.25 x 0.45 | 30.9 | 40 | 4925.325 |
| | | 4.25 x 0.45 | 40.0 | 40 | 4925.425 |
| | | 5.32 x 0.45 | 49.5 | 40 | 4925.532 |
| | | 6.32 x 0.45 | 59.0 | 40 | 4925.632 |
| | | | | | |
| 5 | Intermediate transom for lattice beam, 0.73 m incl. 4 bolts, for lattice beams 4912 and 4922 Supplement for lattice beam | | 6.5 | 50 | 4924.073 |
| 6 | Unit beam spigot T16, dia. 38 mm for straight extension of lattice beam Ref. Nos. 4912, 4922, 4902, 4903, 4925 | 0.54 | 2.4 | 350 | 4925.000 |
| 7 | Special bolt M12 x 60, with nut | Required: 4 pcs. each | 4.0 | 50 | 4905.061 |

| Pos. | Description | Dimensions L/H x W [m] | Weight approx. [kg] | PU [pcs.] | Ref. No. |
|------|------------------------------------------------------------------|---------------------------|------------------------|--------------|-----------------|
| 8 | Longitudinal barrier | 0.73 | 2.0 | 70 | 1787.073 |
| | | 1.09 | 2.7 | 70 | 1787.109 |
| | | 1.57 | 3.6 | 70 | 1787.157 |
| | | 2.07 | 4.6 | 70 | 1787.207 |
| | | 2.57 | 5.6 | 70 | 1787.257 |
| | | 3.07 | 6.5 | 70 | 1787.307 |
| 9a | Transverse barrier 0.73 m right | 0.73 | 2.1 | 70 | 1788.073 |
| 9b | Transverse barrier 0.73 m left | 0.73 | 2.1 | 70 | 1788.074 |
| 10 | Passageway marking 1.50 m with rotating half-couplers | 1.50 | 5.3 | 70 | 1788.150 |

WS = wrench size PU = packaging unit = available ex works = delivery time on request = only available in this packaging unit = the approval process is not yet completed

IND = Layher Individual possible – see page 7

Accessories

The **SpeedyScaf transom 1** is used for constructing intermediate levels.

Many other parts for non-standard scaffolding applications are available on request.

For large roof overhangs, use the installation of **aluminium bridging ledgers 3**. **Spigots 4** on aluminium bridging ledgers hold the assembly frames above them and permit a 0.50 m or 1.00 m reduction of the bay width.

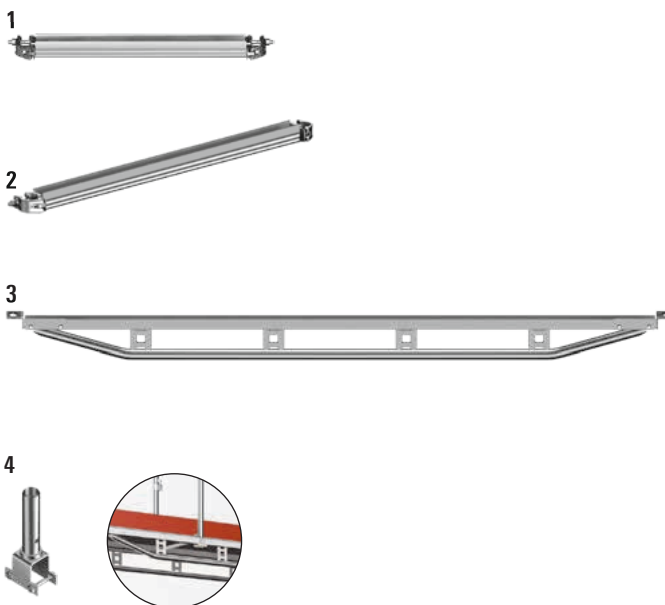

Castors 5

The mobile solution for birdcage, bridge or suspended scaffolding is often the best alternative in terms of technical suitability, scheduling and price. In this field too, the choice, the delivery capability and not least the experience of the manufacturer point to Layher. If scaffolding is made mobile using castors, DIN 4420-3 applies. For these rolling towers, verification of structural strength is required.

Robust castors with twin brake (it brakes wheel and slewing ring) for various loads, offer a safer mobility of the scaffolding – without high effort.

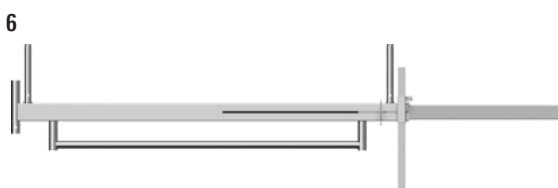









The telescopic device: width max. 3.20 m, min. 2.30 m. The mobile beam can be used for all scaffolding systems (rolling towers, frame, modular and other scaffolding, tube-and-coupler) with a tube diameter of 48.3 mm.



Further castors you'll find in the catalogue System-free Accessories.



| Pos. | Description | Dimensions L / H x B [m] | Weight approx. [kg] | PU [pcs.] | Ref. No. | |
|------|-----------------------------------------------------------------------------------------------------------------------------------------------------------------------------------------------------------------------------------------------------------------|-----------------------------|------------------------|--------------|-----------------------------------------------------------------------------------------------------|-----------------------------------------------------------------------------------------------------|
| 1 | Intermediate transom, 0.73 m with half-coupler, for intermediate layers | WS 19 | 0.73 | 3.9 | 100 | 1742.719 |
| | | WS 22 | 0.73 | 4.0 | 100 | 1742.722 |
| 2 | Intermediate transom, 1.09 m with half-coupler, for intermediate layers | WS 19 | 1.09 | 5.1 | 450 | 1742.119  |
| | | WS 22 | 1.09 | 5.1 | 450 | 1742.122  |
| 3 | Aluminium bridging ledger, 2.57 m Aluminium bridging ledger, 3.07 m for mounting on spigot, for reduction of bay length. | 2.57 | 8.5 | 40 | 1775.257  | |
| | | 3.07 | 9.7 | 90 | 1775.307  | |
| 4 | Spigot incl. 2 bolts for further construction on aluminium bridging ledger Ref. No. 1775 | 0.20 | 1.8 | 250 | 1775.000  | |
| 5 | Castor 700 Plastic wheel, dia. 200 mm. With base plate, adjustment range 0.30 – 0.60 m, spindle nut with lock, castor with twinbrake lever and load centering when braked. Wheel and slewing ring can be locked. Permissible load: 7.0 kN | Ø 0.20 | 6.8 | 70 | 1259.201 | |
| 6 | Mobile beam with bar, 3.20 m, adjustable Steel rectangular tube, hot-dip galvanized. For base widening in special rolling tower structures. | 3.20 | 42.6 | 20 | 1338.320 | |
| 7 | Spigot, adjustable Steel, hot-dip galvanized. For use with mobile beam Ref. No. 4106.032 | 0.46 | 2.1 | 200 | 1337.000 | |

WS = wrench size PU = packaging unit  = available ex works  = delivery time on request  = only available in this packaging unit  = the approval process is not yet completed

IND = Layher Individual possible – see page 7

Weather protection

The **weather protection support 1** is used for tarpaulin coverings against exposure to the weather at the top level of SpeedyScaf structures.

At the top scaffolding level, all assembly frames to which the weather protection support is attached must be anchored to the building for resistance to tension and compression.

The weather protection support must be attached to the guardrail support and to the assembly frame using two swivel couplers, Ref. No. 4702, and additionally braced as shown in the sketch using a steel scaffolding tube (length = 1.50 m). On the outside, tilting pins are used for suspension of the tarpaulins, and at the top there are two guardrail wedge housings for bracing using guardrails.

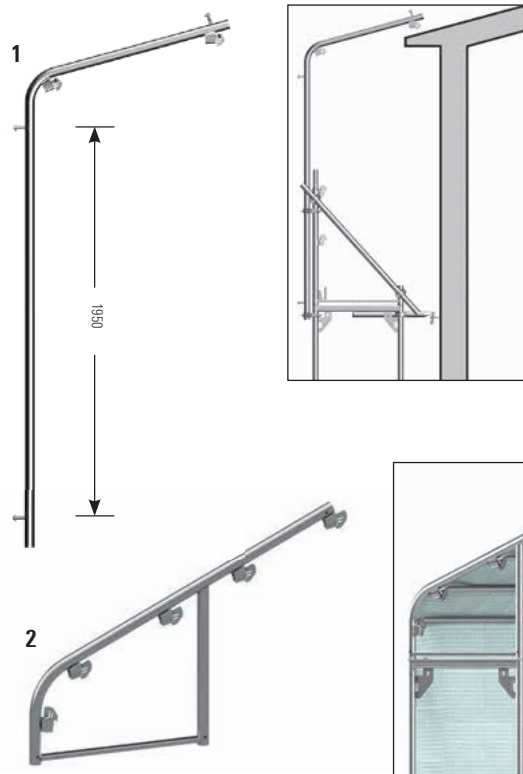
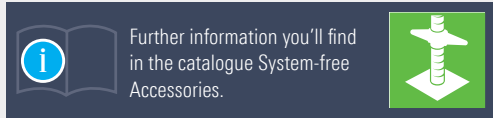



Railing clamp

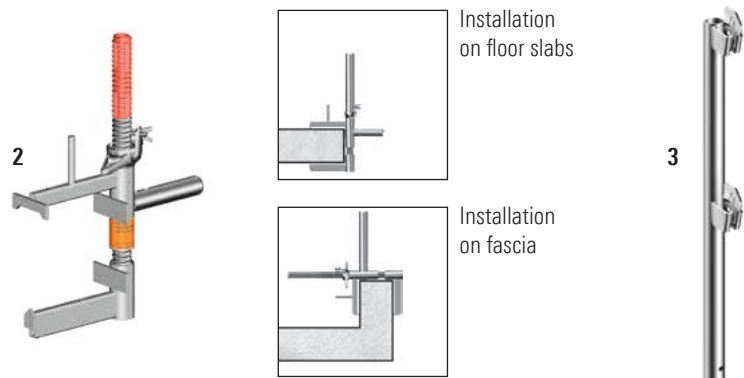

Railing clamp 2

According to German regulations BGV C22 relating to construction work, a fall protection system must be provided for work areas and walkways on roofs and intermediate levels where the height of the fall is more than 2.00 m. The Layher railing clamp satisfies these requirements for securing concrete floor slabs or fascias of 16 – 33 cm in height and flat roofs.

The brick guard must be built in accordance with applicable regulations. The bay widths can be freely selected, max. 3.07 m long. The **guardrail standard 3** is attached to the railing clamp and receives the guardrail. When installing on floor slabs, toe boards must be provided; these can be omitted in installation on fascias.



| Pos. | Description | Dimensions L / H x W [m] | Weight approx. [kg] | PU [pcs.] | Ref. No. |
|------|-----------------------------------------------------------------------------------------------------------------------------------------------------------------------------------|-----------------------------|------------------------|--------------|----------------------------------------------------------------------------------------------|
| 1 | Weather protection support On the outside, tilting pins for suspension of the tarpaulin, at the top there are two guardrail wedge housings for bracing using guardrails | 2.00 | 13.2 | 20 | 1746.000  |
| 2 | Uni weather protection bracket with 5 guardrail boxes for stiffening with single or double guardrails | 0.73 | 12.4 | 20 | 1746.001 |

| Pos. | Description | Dimensions L / H x W [m] | Weight approx. [kg] | PU [pcs.] | Ref. No. |
|------|---------------------------|-----------------------------|------------------------|--------------|------------------------------------------------------------------------------------------------|
| 2 | Railing clamp | 0.58 | 7.0 | 40 | 4015.100  |
| 3 | Guardrail standard | 0.88 | 4.7 | 50 | 4015.101  |

Example for use of the railing clamp on floor slab:

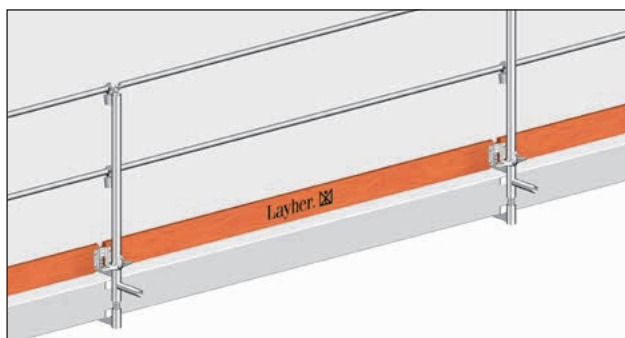

Example for use of the railing clamp on fascia:

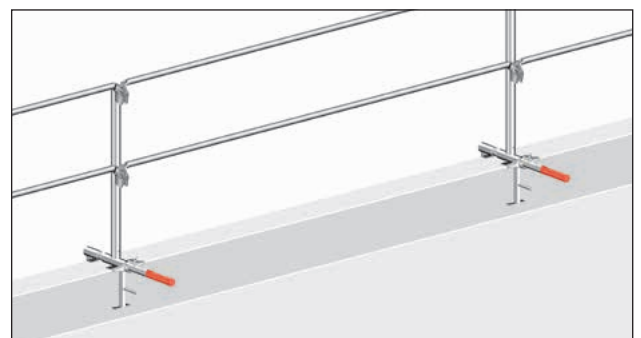

WS = wrench size PU = packaging unit  = available ex works  = delivery time on request  = only available in this packaging unit  = the approval process is not yet completed

IND = Layher Individual possible – see page 7

Accessoires

Scaffolding couplers 1/2 connections, in steel, drop-forged; as per DIN EN 74 and general building authority approval from the DIBt (German Civil Engineering Institute). Tightening torque of collar nuts 50 Nm.

Standardised **scaffolding tubes 3** in steel (hot-dip galvanized) or aluminium permit, in conjunction with scaffolding couplers, special assembly and extension outside the regular version.



Further scaffolding couplers can be found in the catalogue for System-free Accessories.



For right-angled connection of tubes with dia. 48.3 mm

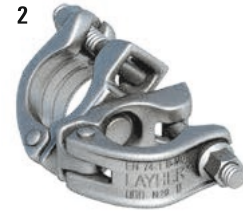

For connection at any angle of tubes with dia. 48.3 mm





Tools

Identification and prohibition signs for work scaffolding as per DIN EN 12811-1. Suitable **see-through pocket 8** made of transparent plastic for weather protection. The three-piece **scaffolding identification pad 6** with carbon copy developed to tag work scaffolding. The right part is the inspection record for your files. Your client gets the carbon. On the back side of the carbon, important application notes are listed.

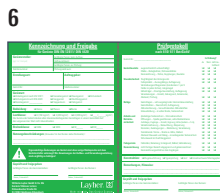
The **high-quality scabbling pick 7** on the hammer head ensures a consistently safe use. The additional hardened inner tube provides a standard breaking strength. In addition, the reinforced scabbling pick has a patented head-stem-connection, which also forgives failures. The orange handle provides good handling, good cushioning and low-fatigue working.



| Pos. | Description | | Dimensions L / H x W [m] | Weight approx. [kg] | PU [pcs.] | Ref. No |
|------|--------------------------------------------------------------------------------------------------------------------------------------|-------|-----------------------------|------------------------|--------------|----------|
| 1a | Double coupler Class BB, EN 74-1 RA BB C3 M quality-monitored, for use in class B and BB on steel and aluminium tube | WS 19 | | 1.3 | 450 | 4700.019 |
| | | WS 22 | | 1.3 | 450 | 4700.022 |
| 1b | Double coupler with coarse thread Description as Pos. 1a acc. to approval Z-8.331-947 | WS 19 | | 1.3 | 450 | 4777.019 |
| | | WS 22 | | 1.3 | 450 | 4777.022 |
| 2a | Swivel coupler Class B, EN 74-1 SW B C3 M, quality-monitored, for use in class B on steel and aluminium tube | WS 19 | | 1.5 | 450 | 4702.019 |
| | | WS 22 | | 1.5 | 450 | 4702.022 |
| 2b | Swivel coupler with coarse thread Description as Pos. 2a acc. to approval Z-8.331-947 | WS 19 | | 1.5 | 450 | 4778.019 |
| | | WS 22 | | 1.5 | 450 | 4778.022 |
| 3 | Scaffolding tube , steel, hot-dip galvanized Scaffolding tubes dia. 48.3 x 4.0 mm, as per DIN EN 39 | | 1.00 | 4.5 | 61 | 4600.100 |
| | | | 2.00 | 9.0 | 61 | 4600.200 |
| | | | 3.00 | 13.5 | 61 | 4600.300 |
| | | | 4.00 | 16.7 | 61 | 4600.400 |
| | | | 5.00 | 22.7 | 61 | 4600.500 |
| | | | 6.00 | 25.0 | 61 | 4600.600 |

| Pos. | Description | | Dimensions L / H x W [m] | Weight approx. [kg] | PU [pcs.] | Ref. No. |
|------|----------------------------------------------------------------------------------------------------------------------------------------------|-------|-----------------------------|------------------------|------------------------------------------------------------------------------------------|------------------------------------------------------------------------------------------------|
| 4 | Ratchet spanner with reinforced head | WS 19 | 0.32 | 0.7 | 600 | 4740.019 |
| | | WS 22 | 0.32 | 0.7 | 600 | 4740.022 |
| 5 | Magnetic spirit level | | | 0.4 | 50 | 4006.666 |
| 6 | Scaffolding identification pad Pad with 50 + 50 pieces (Original + Carbon) with centre perforation and foldover as carbon-block | | DIN A4 | 0.5 | | 6344.500  |
| 7 | Scabbling pick, 600 g reinforced | | 0.32 | 0.8 | 300 | 4421.051  |
| 8 | See-through pocket for Ref. No. 6344.201 and 6344.500 with lock flag when inspection record is not inserted | | 0.30 x 0.17 | 0.4 | 10  | 6344.010 |

WS = wrench size PU = packaging unit  = available ex works  = delivery time on request  = only available in this packaging unit  = the approval process is not yet completed

 = Layher Individual possible – see page 7

Fall protection

According to German DGUV 38 regulations, equipment to prevent falls by personnel must be provided for work areas and walkways where the height of the fall is more than 2.0 m.

The **PSA-safety harness AX 60 C 1** has impressive features:

- ▶ Comfortable, padded and ergonomic back support
- ▶ Convenient tool holders and click-locks for easy fastening
- ▶ High operational dependability and absolute freedom from maintenance, plus very simple fastening
- ▶ Operating errors are not possible, as the equipment operates in any position
- ▶ Excellent running even under gruelling working conditions
- ▶ Enormous distribution of forces in the event of a fall

Before use, visual checks must be performed regularly to ensure correct working order. In accordance with German BGR 198 regulations, all personal safety equipment must be inspected at least once a year by an expert. The maximum permissible period of use for the equipment must not be exceeded.

The **advance guardrail post 4/5**, the **advance telescopic guardrail 1.57/2.07 m**, the **advance telescopic guardrail 2.57/3.07 m 6** and the **End-AGS 7** are used for temporary protection against falls during assembly of scaffolding parts on the uppermost, unsecured scaffolding level.

Extension lengths

| Article | L min. | L max. |
|--------------------------------|--------|--------|
| Assembly guardrail 1.57/2.07 m | 1.57 m | 2.90 m |
| Assembly guardrail 2.57/3.07 m | 2.20 m | 3.70 m |



Scaffolding pallets

Tube pallets

in square shape (85) or in rectangular shape (125). The pallets are open on all sides. Tubes, standards, guardrails, diagonal braces, toe boards are transported and stored with this pallet. The empty pallets, stored permanently in the base frame using pallet posts, can be transported and stored in a space-saving way.

Tube pallet 125 11

The following can be transported, for example: 13 Frames, 0.73 m or 11 Robust decks 0.61 m or 15 Stalu decks 0.61 m or 24 Steel decks 0.32 m.

Modular pallet and skeleton box 13/14

The palette or the skeleton box can be stacked with Euro pallets. Crane eyelets at top; an opening allows stacked material to be removed even if several pallets are stacked one above the other. The integrated timber base plate is 30 mm thick and it's nailed onto 50 x 50 mm square timbers.

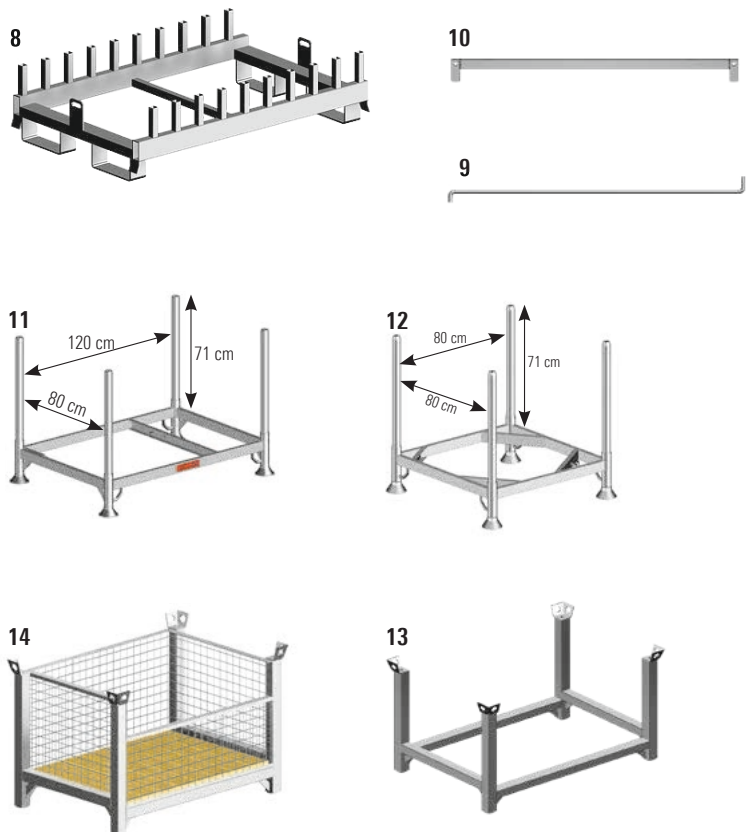

More pallets you'll find in the catalogue System-free Accessories.



| Pos. | Description | Dimensions L / H x W [m] | Weight approx. [kg] | PU [pcs.] | Ref. No. |
|------|--------------------------------------------------------------------------------------------------------------------------------------------------------|-----------------------------|------------------------|--------------|----------|
| 1 | PSA-safety harness AX 60 C with extension, 0.50 m conforms EN 361 | | 1.8 | 5 | 5969.160 |
| 2 | PSA-Flex safety rope, 2.00 m with fall arrester and snap hook FS 90; as per EN 354 / EN 355 self-shortening to reduce tripping hazards | 2.00 m | 1.1 | 20 | 5969.501 |
| 3 | PSA scaffolding construction set Pos. 1 and 2 safety harness, safety rope 2.00 m, backpack (Use only in scaffolding construction) | | 3.5 | 50 | 5969.170 |
| 4 | Advance guardrail post Aluminium for one advance guardrail (1.00 m high); rapid attachment of guardrails with tilting pins | | 4.2 | 50 | 4031.001 |
| 5 | Advance guardrail post Aluminium for two advance guardrails (0.50 m and 1.00 m high); rapid attachment of guardrails with tilting pins | | 4.2 | 50 | 4031.002 |
| 6 | Assembly guardrail, 1.57 / 2.07 m, Aluminium Assembly guardrail, 2.57 / 3.07 m, Aluminium | 1.70 | 3.2 | 50 | 4031.207 |
| | | 2.30 | 4.0 | 50 | 4031.307 |
| 7 | Advance guardrail system (AGS) for scaffolding end Aluminium, single-part | 2.20 x 0.70 | 9.8 | 5 | 4031.000 |

| Pos. | Description | Dimensions L / H x W [m] | Weight approx. [kg] | PU [pcs.] | Ref. No. |
|------|--------------------------------------------------------------------------------------------------------------------------------------------------------------------------------------------------------------------------------------------------------|-----------------------------|------------------------|--------------|----------|
| 8 | Assembly frame pin pallet 0.73 m 1.09 m | | | | |
| | | 1.20 x 0.77 | 34.0 | 10 | 5113.073 |
| | | 1.20 x 1.13 | 36.2 | 10 | 5113.109 |
| 9 | Retaining rod 1 retaining rod necessary per pallet | 1.20 | 2.1 | 500 | 5113.120 |
| 10 | Retaining bar | 1.12 | 3.1 | 500 | 5110.112 |
| 11 | Tube pallet 125 Steel, hot-dip galvanized, length of pallet posts: 0.86 m, load 1500 kg | 1.37 x 0.97 | 32.0 | 10 | 5105.125 |
| 12 | Tube pallet 85 Steel, hot-dip galvanized, length of pallet posts: 0.86 m, load 1500 kg | 0.97 x 0.97 | 30.8 | 10 | 5105.085 |
| 13 | Modular pallet Steel, hot-dip galvanized, fill height 0.74 m, load 2000 kg, external dimensions 1.26 x 0.86 m | 1.20 x 0.80 | 45.0 | 5 | 5101.061 |
| 14 | Modular skeleton box Steel, hot-dip galvanized, fill height at front 0.53 m, fill height at rear 0.74 m, load 2000 kg, external dimensions 1.26 x 0.86 m consisting of 5113.000 Modular skeleton box and 6494.514 timber base plate | 1.20 x 0.80 | 85.8 | | 5113.002 |

WS = wrench size PU = packaging unit = available ex works = delivery time on request = only available in this packaging unit = the approval process is not yet completed

= Layher Individual possible – see page 7

Index

| | | | | | |
|---------------------------------|------------|-------------------------------------|--------|----------------------------------|----------------|
| A | | | | | |
| Access deck | 16 | Diagonal brace | 20 | Intermediate frame | 28 |
| Access ladder | 17 | with 2 half-couplers | 21 | aluminium | |
| T15 | 17 | with wedge half-coupler | 21 | 0.73 m | 29 |
| Accessories | 34 | Diagonale | 20 | steel | |
| Adapter for brick guard support | | Double coupler | 26, 39 | 0.73 m | 29 |
| 0.36/0.50/0.73 m | 29 | with coarse thread | 39 | 1.09 m | 29 |
| Adjustable guardrail | 18 | Double end guardrail | 18 | Intermediate transom | |
| Adjustment frame | 10 | 0.73 m | 19 | 0.73 m | 35 |
| Adjustment plate for base plate | 9 | Double guardrail | 18, 28 | 1.09 m | 35 |
| Advance guardrail post | 40, 41 | aluminium | 19 | for lattice beam | 33 |
| Advance guardrail system (AGS) | 41 | steel | 19 | Internal guardrail | 31 |
| Advance telescopic guardrail | | Double-pin coupler | | Internal guardrail fixing device | 18 |
| 1.57/2.07 m | 40 | SGS | 29 | Internal scaffolding access | 10, 16 |
| 2.57/3.07 m | 40 | SR | 29 | | |
| Aluminium bridging ledger | 34 | E | | L | |
| 2.57 m | 35 | Eaves bracket | | Lattice beam coupler | 32, 33 |
| 3.07 m | 35 | 1.00 m | 24, 25 | LayPLAN | 8 |
| Aluminium platform stair | 30 | End-AGS | 40 | Lock against lift-off | 24, 25 |
| Assembly frame | 10, 12, 26 | End guardrail | 18 | Locking pin | 12, 13, 17, 28 |
| aluminium | | End toe board | 21 | Lock nut | 27 |
| 1 guardrail wedge housing | 11 | ETICS hanger bolt | 27 | Longitudinal barrier | 33 |
| Assembly frame LW | | ETICS-tie | 26 | | |
| steel | | 800 complete | 27 | M | |
| 1 guardrail wedge housing | 11 | ETICS-tie rod | | Magnetic spirit level | 39 |
| 2 guardrail wedge housing | 11 | 380 | 27 | Mobile beam with bar | 35 |
| Assembly frame pin pallet | 41 | 480 | 27 | Modular pallet | 40, 41 |
| Assembly guardrail | | F | | Modular skeleton box | 40, 41 |
| 1.57/2.07 m | 41 | Fan support | 28, 29 | Modular stair | 30 |
| 2.57/3.07 m | 41 | | | | |
| | | G | | O | |
| B | | Gantry frame LW | 12, 13 | Open ended wrench | 27 |
| Base ledger | 21 | Gap covers | 16 | Outer platform stair access | 30 |
| Base plate | 8 | Gap deck | 16 | | |
| 60 | 9 | Guardrail, adjustable | 19 | P | |
| 80, reinforced | 9 | Guardrail box for Speedy frame | 18, 19 | Passageway marking | 33 |
| 150, reinforced | 9 | Guardrail closure | 28 | Pedestrian protection | 28 |
| Brick guard support | 28 | Guardrail closure, top | 28 | Peg extraction device | 27 |
| | | Guardrail coupler | 18 | Plastic pipe | 27 |
| | | with box | 19 | Plastic wall insert | 27 |
| C | | Guardrail post | 28, 29 | Plug-in console bracket | |
| Cap | 27 | Guardrail standard | 36 | 0.22 m | 22, 23 |
| Castor | 34 | Guardrail wedge housing cover | 13 | 0.36 m | 22, 23 |
| 700 | 35 | Gusset coupler | 27 | Protection net | |
| Combi-bracket | 23 | | | without quick belt | 29 |
| 0,36 m | 23 | H | | PSA-Flex safety rope | 41 |
| Comfort stair | 30 | Half-coupler with toe board pin | 20, 21 | PSA-safety harness AX 60 C | 40, 41 |
| Console bracket | 22 | Hatch-type access with offset hatch | 16 | PSA scaffolding construction set | 41 |
| 0.22 m | 22, 23 | | | | |
| 0.36 m | 22, 23 | I | | Q | |
| 0.50 m | 22, 23 | Individual stamping | 14 | Quick belt | 29 |
| 0.73 m | 22, 23 | Individual toe board | 20 | | |
| 0.73 m, reinforced | 24, 25 | Initial stair guardrail | 31 | R | |
| 0.73 m, swivelling | 24, 25 | | | Railing clamp | 36, 37 |
| 1.09 m | 24, 25 | | | Ratchet spanner | 39 |
| Corner deck, adjustable | 16, 17 | | | Reducer | 12, 13 |
| | | | | Retaining bar | 41 |
| D | | | | Retaining rod | 41 |
| Deck, 0.61 m | 22 | | | | |

| | | | | | |
|-----------------------------------------|----------------|----------------------------------------------------|------------|----------------------------------------------|--------------|
| Ring screw | 27 | Stairwell guardrail | 31 | U-starting stair aluminium 0.64 m wide | 31 |
| Roofer's guard system | 28 | Standard brick guard | 28 | U-start ledgers | 10, 16 |
| S | | Starter U-transom | 11, 30, 31 | U-steel deck, 0.19 m wide | 15 |
| Scabbling pick, 600 g | 39 | Steel-gap cover, 0.32 m wide | 17 | U-steel deck T4, 0.32 m wide | 15 |
| Scaffolding access | | Steel lattice beam 450 | 33 | U-Xtra-N deck 0.61 m wide | 14 15, 17 |
| external | 16 | Steel plank | 16 | | |
| internal | 16 | 0.20 m | 17 | | |
| Scaffolding access, outside | 30 | 0.30 m | 17 | | |
| Scaffolding barriers | 32 | Steel tube, 33.70 mm | 15 | W | |
| Scaffolding couplers | 38 | Swivel coupler | 39 | Wall tie | 26 |
| Scaffolding identification pad | 38, 39 | with coarse thread | 39 | Weather protection support | 36, 37 |
| Scaffolding lock | 28, 29 | Swivelling base plate 60, reinforced | 9 | Wedge spindle swivel coupler | 9 |
| Scaffolding plank | 9 | System lattice beam | 32 | | |
| Scaffolding tube | 38, 39 | T | | | |
| Section brace | 21, 22, 24, 25 | Telescopic gap deck | 16, 30 | | |
| Securing screw | 17 | Telescopic U-gap deck | 17 | | |
| See-through pocket | 38, 39 | Toe board | 20, 21 | | |
| Single end guardrail | | Tools | 38 | | |
| 0.73 m | 19 | Top end frame | 28 | | |
| Single guardrail | 18, 19 | Transverse barrier | 33 | | |
| Software for scaffolding construction | 8 | Tube pallet | 40 | | |
| Special bolt | | 85 | 41 | | |
| M12 x 60 | 33 | 125 | 40, 41 | | |
| Speedy assembly frame | | U | | | |
| aluminium | 13 | U-alu deck, perforated, 0.32 m wide | 15 | | |
| Speedy assembly frame LW | | U-aluminium access deck, 0.61 m wide | 17 | | |
| 2.00 m, for balustrade | 13 | U-aluminium hatch-type access deck | 17 | | |
| steel | 13 | U-base section | 11 | | |
| 2 guardrail wedge housings | 13 | U-comfort stair aluminium 0.64 m wide | 31 | | |
| 4 guardrail wedge housings | 13 | U-corner deck | 17 | | |
| Speedy Internal guardrail fixing device | | U-deck for equalisation | 17 | | |
| without toe board pin | 19 | U-distance coupler | 30, 31 | | |
| with toe board pin | 19 | U-hatch-type steel access deck | 17 | | |
| SpeedyScaf corner adapter | 11 | U-ledger for lattice beam | 33 | | |
| SpeedyScaf corner plate coupler | 26 | Unit beam spigot T16 | 33 | | |
| SpeedyScaf lattice beam | | Universal U-Lift-off preventer | 25 | | |
| aluminium | 33 | Uni weather protection bracket | 37 | | |
| SpeedyScaf lattice beam LW | 32 | U-platform stair aluminium 0.64 m wide | 31 | | |
| Stahl | 33 | U-robust deck 0.61 m wide | 15 | | |
| SpeedyScaf roof guard | 29 | U-robust hatch-type access 0.61 m, hatch offset | 17 | | |
| SpeedyScaf roof guard support | | U-robust hatch-type access deck 0.61 m wide | 17 | | |
| 0.36/0.50/0.73 m | 29 | U-stalu deck | 14 | | |
| SpeedyScaf transom | 10, 16, 34 | U-stalu deck T9 0.19 m wide | 15 | | |
| SpeedyScaf wall tie | 26, 27 | 0.32 m wide | 15 | | |
| Spigot | 34, 35 | 0.61 m wide | 15 | | |
| adjustable | 35 | | | | |
| Stair access | 30 | | | | |
| Stair foot section | | | | | |
| 0.60 m | 31 | | | | |
| 0.95 m | 31 | | | | |
| Stair guardrail | 31 | | | | |
| Stair-guardrail post | 31 | | | | |
| Stair head section | | | | | |
| 0.60 m | 31 | | | | |
| 0.95 m | 31 | | | | |
| Stair middle section | | | | | |
| 0.60 m | 31 | | | | |
| 0.95 m | 31 | | | | |

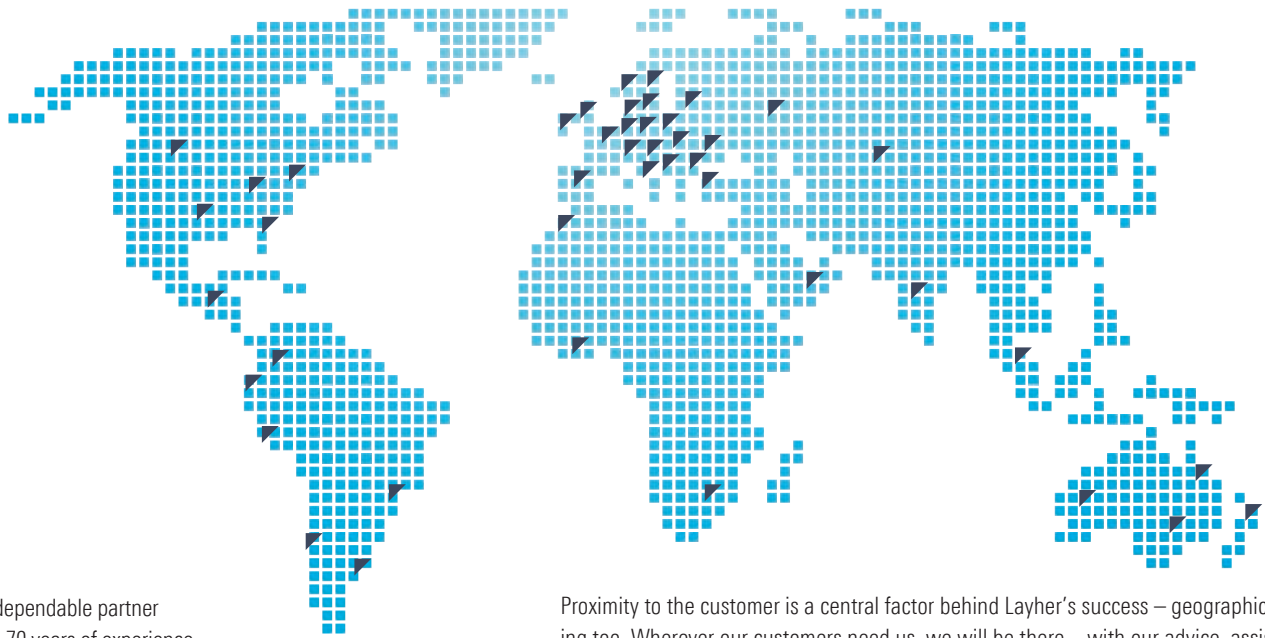

Layher is your dependable partner with more than 70 years of experience. "Made by Layher" always means "Made in Germany" too – and that goes for the entire product range. Superb quality – and all from one source.

Proximity to the customer is a central factor behind Layher's success – geographically speaking too. Wherever our customers need us, we will be there – with our advice, assistance and solutions.

-  **SpeedyScaf**
-  **Allround Scaffolding**
-  **System-free Accessories**
-  **Protective Systems**
-  **Shoring**
-  **Event Systems**
-  **Rolling Towers**
-  **Ladders**



Headquarters in Eibensbach



Plant 2 in Gueglingen

Layher 

More Possibilities. The Scaffolding System.

Wilhelm Layher GmbH & Co KG
Scaffolding Grandstands Ladders

Ochsenbacher Strasse 56
74363 Gueglingen-Eibensbach
Germany

Post Box 40
74361 Gueglingen-Eibensbach
Germany
Telephone +49 (0) 71 35 70-0
Telefax +49 (0) 71 35 70-2 65
E-mail export@layher.com
www.layher.com

