

## LAYHER ACCESS TECHNOLOGY CATALOGUE

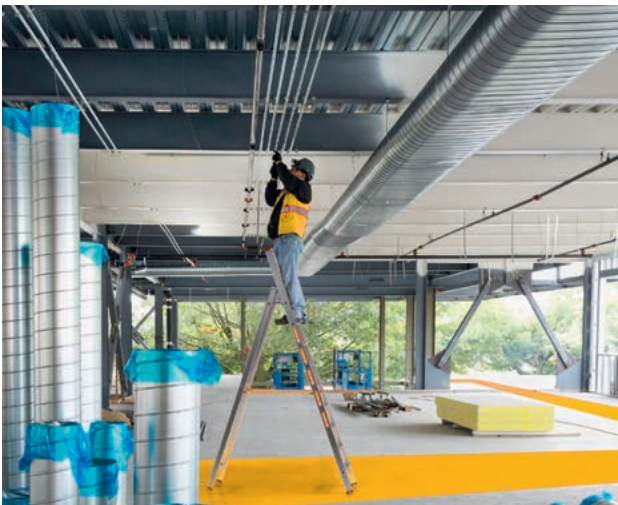

Edition 04.2018  
Ref. No. 8118.229

Quality management  
certified according  
to ISO 9001:2008



# Contents

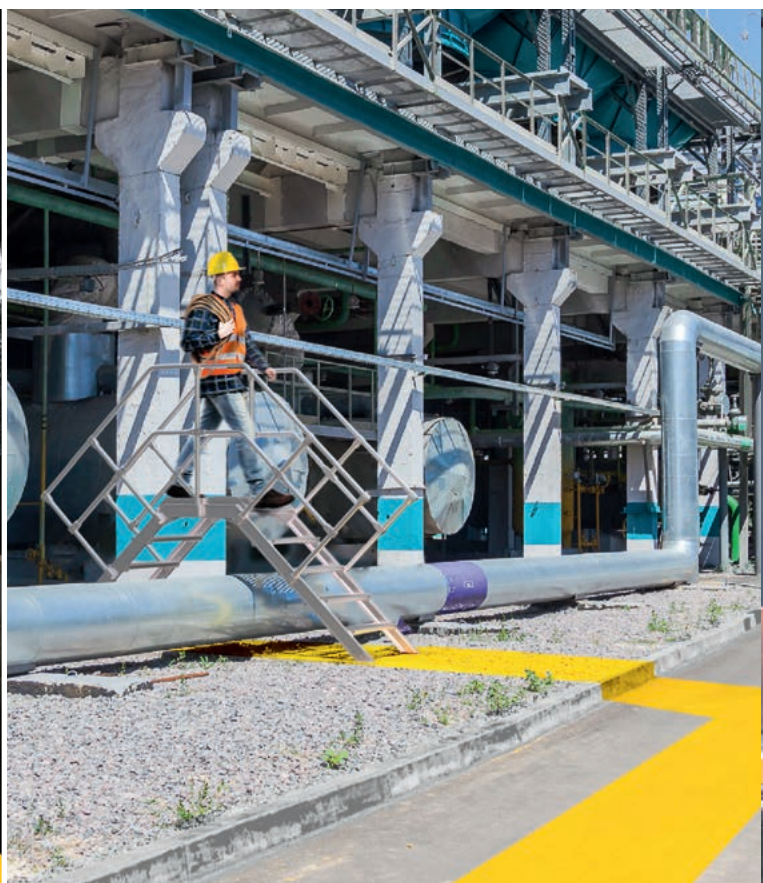

## LADDERS FROM PAGE 8



Single ladders	8
Double ladders	12
Multifunction ladders	15
Alu telescopic stage	17
Platform ladder	18
Work trestles, wooden steps	19
Aluminium steps	19
Accessories	20
Spare parts	22
Roof ladders	24

## ALU-BOXES FROM PAGE 26



Alu all-purpose boxes	26
-----------------------	----

## ACCESSES FROM PAGE 27



Start-stairway	28
Stairways	29
Stairways with platform	30
Maintenance platforms	31
Bridging stairways	32



## ROLLING TOWERS FROM PAGE 34



Rolling tower configurator	36
Safety structure P2	38
Zifa tower	40
Uni light rolling tower	46
Uni compact rolling tower	52
Uni standard rolling tower	58
Uni wide rolling tower	64
Uni Comfort	70
Staro rolling tower	74
Extension and spare parts	82

## ALU BRIDGING BEAM FROM PAGE 24

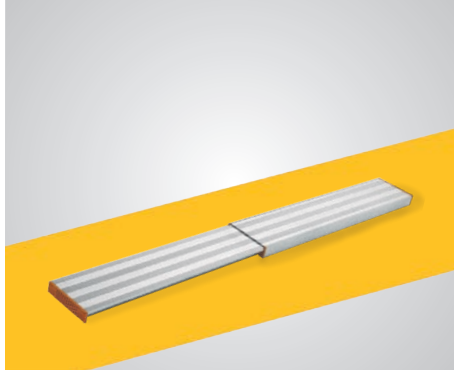

Telescopic Stages	17 or 76
Alu bridging beam	76

## NOTICE

All dimensions and weights are guideline values. Subject to technical modification.

Our deliveries shall be made exclusively in accordance with our currently valid General Terms of Sale. These include the following provisions:

- ▶ The place of performance is Gueglingen-Eibensbach.
- ▶ Title to the delivered goods shall be retained until full payment has been made.

Steel components are galvanized according to EN ISO 1461 and DAST guideline 022. Connection parts are galvanized according to EN ISO 4042.

Please request the specific instructions for assembly and use when ordering. Protected by copyright. Not to be reproduced, either in whole or in part. Misprints and errors excepted.

Layher

# MADE IN GERMANY – MADE BY LAYHER



Headquarters in Eibensbach



Plant 2 in Gueglingen

## HERE IS THE BEATING HEART OF LAYHER.

Quality made by Layher comes from Gueglingen-Eibensbach. Our company has set down deep local roots since it was established. Right up until today, development, production, logistics and management are all in one place. Proximity to development, logistics and administration creates benefits to our customers around the world: short ways, short response times, controlled quality and manufacturing. The production can be adapted to the requirements at short notice and to the needs of the customers.

## SIMPLY SAFE. THE ACCESS TECHNOLOGY.

This brand promise made by Layher is the expression of a brand philosophy that we've been living by for over 70 years. Quality assurance, future-proofing, delivery-securing, operational safety and long-lasting partnership are advantages that can be used to extend or increase your business opportunities and success in the long term. With comprehensive services, a permanent range of training courses and an ethos of customer focus, more than 1,700 dedicated Layher employees are creating more possibilities for our customers every single day. In more than 40 countries all over the world.

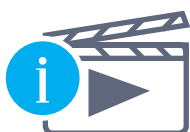

### MORE INFORMATION

Discover the world of Layher  
in its company film at:  
[yt-image-en.layher.com](http://yt-image-en.layher.com)



## QUALITY ASSURANCE

- ▶ Our products are only "made in Germany".
- ▶ The comprehensive quality assurance from goods receiving to shipping guarantees constant product quality according to ISO 9001.
- ▶ We use modern manufacturing processes.
- ▶ Our products comply with the very latest security standards and possess German TÜV approval and many other certifications.
- ▶ Our products are famous for their quality and economics.



## FUTURE-PROOFING

- ▶ Layher acts as family-owned company in third generation in long-term and customer orientated.
- ▶ We are a long-term thinking and acting partner.
- ▶ We are pioneers in development and market launching of new products and solutions for access technologies.
- ▶ For qualification of your technical or commercial employees, we offer a comprehensive seminar program.
- ▶ We stand for a long-term deliverability of spare-parts or accessories.



## DELIVERY-SECURING

- ▶ We offer a well-assorted product range in 30 service centers near you in Germany.
- ▶ As part of our 3-stage distribution channel, we ensure fast, short-term supply of the material to specialist dealers or users on site.
- ▶ Thanks to flexible production capacities, we are able to produce also large quantities in a short term.
- ▶ Short ways and personal contact persons in the internal and external service and in technical departments ensure fast and uncomplicated support.

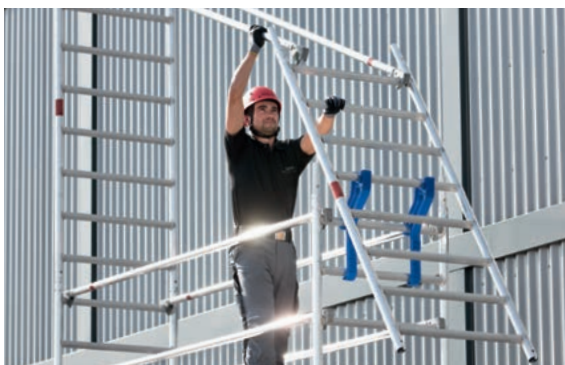

## OPERATIONAL SAFETY

- ▶ Our ladders and rolling towers comply with the valid safety regulations and regulations for occupational safety.
- ▶ This gives the user a high level of occupational safety.
- ▶ Practical seminars and technical documents increase the safety during use.



## PARTNERSHIP

- ▶ For good advice and intensive support for specialist retailers or users on site 10 Layher access technology area sales managers are in the field.
- ▶ Layher Steigtechnik stands for short distances and personal advice.
- ▶ We invest a lot in trustful cooperation and maintain customer relationships at all levels. Partnership simply safe.

## Ladders

## LAYHER LADDERS

THE QUALITY IS IN THE DETAILS

**Plastic-sheathed steel joints**

- ▶ Play-free screw connection for long life.

**Stile section**

- ▶ Torsion stiff stile section for high loads at low weight.
- ▶ Beading along the outer stile face prevents damage to the rung flanges, for example when they are slid over the edges of the truck loading area.

**Quadruple folding**

- ▶ Increased contact area by rung folding on the inner stile face.
- ▶ Higher forces can be transmitted.
- ▶ Optimal stile-rung-connection.

**Triangular rungs and grooving**

- ▶ Sure footing by heavily grooved rungs and steps.
- ▶ Increased turning protection within the stiles thanks to triangular rung shape.

**Combigrip ladder foot**

- ▶ Optimal hold with good slipping prevention.
- ▶ Easy and fast retrofitting of ladder cross-pieces for single ladders.

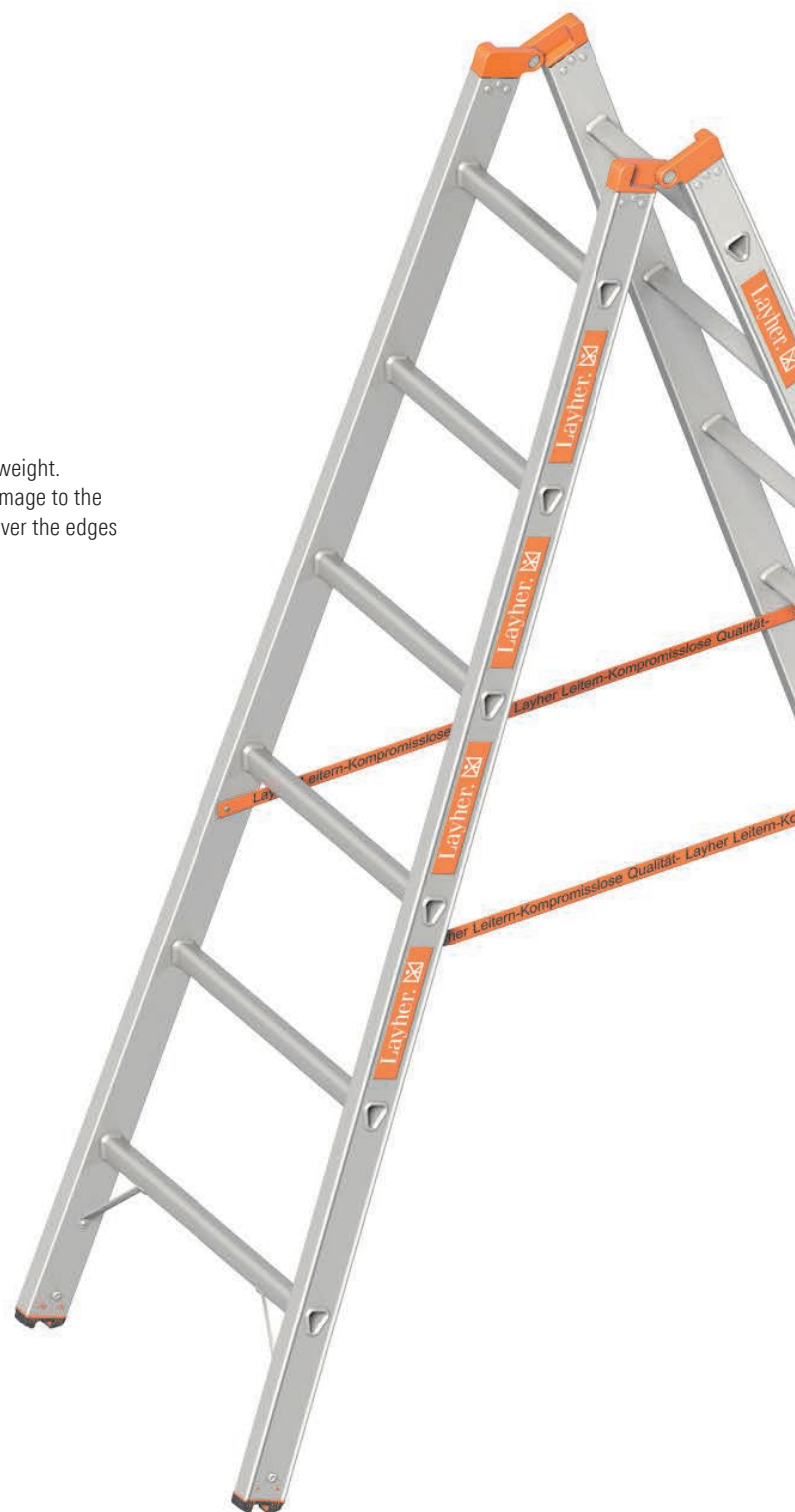

With Layher ladders you don't just get the statutory warranty, but benefit from a 5-year Layher warranty. It covers material and workmanship flaws in all aluminium and steel parts. It starts from the purchase date of the product, as printed on your receipt.

The claims arising from this warranty will be processed at the location of one of our many branches or delivery warehouses in Germany or at our head office.

**Documented safety:** Layher products can be measured by these quality and safety standards:



# WITH EFFECT FROM 1 JANUARY 2018 – IMPORTANT INFORMATION ON AMENDMENT OF STANDARD DIN EN 131

## DIN EN 131-1

**What is being changed?** With effect from 1 January 2018, extensive amendments to the standard will come into force for ladders used in the commercial field as simple ladders and will require a cross-piece for simple ladders with a length of 3 metres and above. This also includes multi-function ladders usable as simple ladders. The width of the cross-piece is proportionate to the ladder length and to the external width of the ladder, widening as the ladder length increases.

**What does that mean for dealers?** As a general principle your warehouse stocks are protected. You can still sell the ladders you purchased prior to 1 January 2018 without cross-pieces.

- ▶ Layher recommends however that simple ladders be immediately modified to comply with the current standard in accordance with DIN EN 131-1.

**What does that mean for end users?** Commercial users can use their simple ladders without cross-pieces until the next scheduled ladder inspection. After that, the ladders must be upgraded to conform to the new standard (i.e. with cross-pieces).

- ▶ Layher ladders are, thanks to the Combigrip ladder foot, simple to equip with cross-pieces so that they conform to the valid standard.

## DIN EN 131-2

**What is being changed?** All ladders will be categorised as commercial-use or private-use-only ladders. This categorisation is based on a differing basic load during individual tests on the ladders (2250 N to 2700 N). Furthermore, 'durability test for double ladders', 'slip resistance test on floors for simple ladders', 'stability test of simple ladders with lateral stabilisation devices' and 'twisting test for simple ladders' have been added. The purpose of these additional tests is to improve the stability and safety of the products when in use. Ladders approved for commercial use may be used in private households too.

**What does that mean for dealers?** When selling the ladders, the intended use (private or commercial purposes) must be borne in mind. The approved application is identified by the following pictograms.



- ▶ All Layher ladders meet, without exception, the requirements for commercial use and hence also for private use.

**What does that mean for end users?** In the commercial field, only ladders approved for that purpose and identified by appropriate pictograms may be used.

- ▶ All Layher ladders meet, without exception, the requirements for commercial use and hence also for private use.

## DIN EN 131-3

**What is being changed?** Starting in mid-2018, user information (instructions for assembly and use) must be supplied in printed form with every ladder. The label must now show the precisely specified DIN pictograms.

**What does that mean for dealers?** Starting in mid-2018, instructions for assembly and use must be supplied with every ladder sold.

- ▶ Layher will implement this requirement starting on the date specified to do so. Instructions for assembly and use will then be enclosed ex works in the ladder packaging. Alternatively, they can be downloaded for printout in the 'Mediathek' at [downloads.layher.com](https://downloads.layher.com) free of charge.

**What does that mean for end users?** The instructions for assembly and use must be kept to hand during use of the ladder.

- ▶ With effect from 1 April 2018, the instructions for assembly and use will be enclosed in the ladder packaging.

## LADDER EXAMINATION

- ▶ Every Layher ladder will be examined before leaving the plant.
- ▶ Please note the date the next examination on the ladder label (depending on the quantity of uses).
- ▶ Layher recommends an annual examination.
- ▶ The examination must be documented and archived and must be performed by a qualified person.

## SAFETY INCLUDED – WE GLADLY SUPPORT YOU

You will find the right ladder control book as well as further information and our instructions for assembly and use at [www.layher.com](http://www.layher.com). If you do not want to check yourself, contact one of our competent specialist retailers with confidence. On the above mentioned website you will find the competent contact person in your area.

## Single ladders

### Single ladder wide TOPIC 1054

The wide single ladder for even more comfortable standing – increased stability and improved lateral stability. Slip-resistant plastic shoes for sure footing.

Clear width: **390 mm**  
Outer width: **450 mm**  
Rung spacing: **280 mm**  
Cross-piece width (from 12 rungs): **1130 mm**

**TIP:**  
With the Layher Combigrip ladder foot, you automatically comply with the new requirements of DIN EN 131-1, which will specify a cross-piece for simple ladders of 3 metres and more length. The Layher Combigrip ladder foot can be quickly and easily retrofitted in TOPIC ladders of earlier generations. Retrofit kits see page 22.

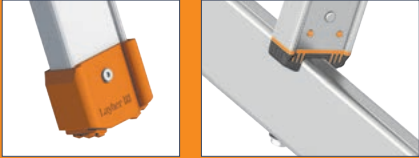

TOPIC 1054

Length [m]	Number of rungs	Standing height [m]	Stile height [mm]	Weight approx. [kg]	Ref. No.	
1.70	6	0.70	64	4.0	1054.006	
2.25	8	1.25	64	5.0	1054.008	
2.80	10	1.75	64	6.0	1054.010	
3.40	12	2.30	64	9.5	1054.012	ⓘ
3.95	14	2.80	64	11.0	1054.014	ⓘ
4.50	16	3.30	64	12.5	1054.016	ⓘ
5.10	18	3.85	64	13.5	1054.018	ⓘ
5.65	20	4.40	76	15.5	1054.020	ⓘ
6.20	22	4.90	76	16.5	1054.022	ⓘ
6.75	24	5.45	100	18.0	1054.024	ⓘ

ⓘ Ladders, highlighted with ⓘ will be delivered ex works with cross-piece.

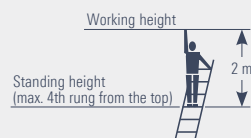

### Single step ladder TOPIC 1042

Single ladder with steps for a wider standing area. Easy to use, maximum safety thanks to slip-resistant plastic shoes.



Clear width: **390 mm**  
Outer width: **450 mm**  
Step spacing: **250 mm**  
Step width: **80 mm**  
Stile height: **76 mm**  
Cross-piece width (from 12 rungs): **1130 mm**

**TIP:**  
With the Layher Combigrip ladder foot, you automatically comply with the new requirements of DIN EN 131-1, which will specify a cross-piece for simple ladders of 3 metres and more length. The Layher Combigrip ladder foot can be quickly and easily retrofitted in TOPIC ladders of earlier generations. Retrofit kits see page 22.

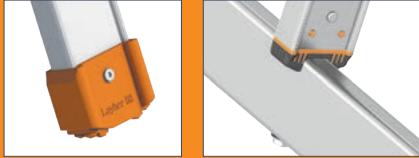

TOPIC 1042

Length [m]	Number of rungs	Standing height [m]	Stile height [mm]	Weight approx. [kg]	Ref. No.	
1.60	6	0.60	300	5.0	1042.006	ⓘ
1.85	7	0.85	300	5.6	1042.007	ⓘ
2.10	8	1.10	300	6.2	1042.008	ⓘ
2.35	9	1.30	300	7.0	1042.009	ⓘ
2.60	10	1.55	300	7.6	1042.010	ⓘ
3.15	12	2.00	300	12.4	1042.012	ⓘ ⓘ
3.65	14	2.50	300	13.4	1042.014	ⓘ ⓘ
4.15	16	2.95	225	14.3	1042.016	ⓘ ⓘ

ⓘ Ladders, highlighted with ⓘ will be delivered ex works with cross-piece.

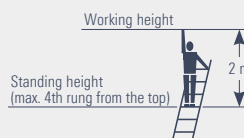



## Truck ladder 1060

Ultra-light simple ladder made of aluminium. Ideal for accessing the truck loading surface.

Optimum stability and functionality from soft rubber shoes around the stile ends. This means that the ladder is suitable not only for access to the loading surface, but also for leaning up against the cab to clean its windscreen without damaging the vehicle paintwork.

Clear width: **300 mm**  
Outer width: **350 mm**  
Rung spacing: **280 mm**



Truck ladder 1060

Length [m]	Number of rungs	Standing height [m]	Weight approx. [kg]	Ref. No.
2.13	7	1.10	3.3	1060.007 

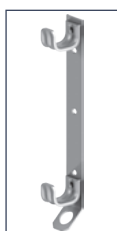

A matching holder is available for optimum attachment of truck ladder 1060 to the vehicle.  
**Ref. No. 1060.001**

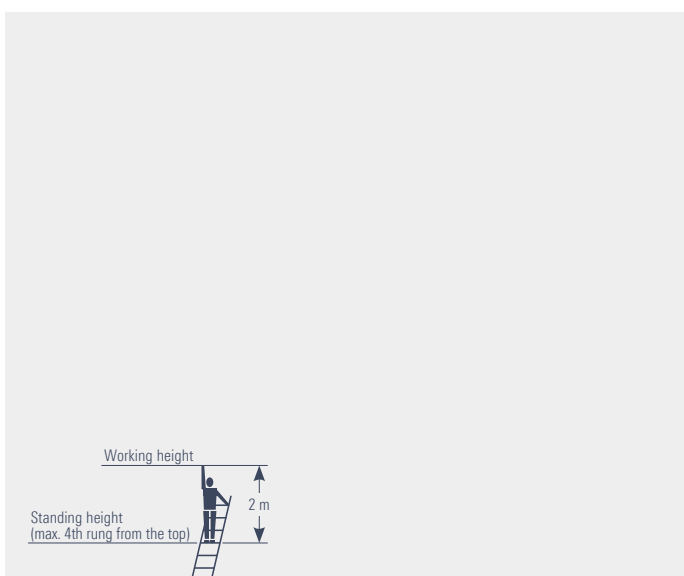

## Wooden single ladder 1052

The wooden single ladder is a simple, sturdy yet high-quality ladder. The stiles are made of solid red pine. The rungs are made from sturdy beechwood.

Thanks to the special square-section studs and a special gluing process, a durable and permanent connection between stile and rung is achieved.

Clear width: **350 mm**  
Outer width: **400 mm**  
Rung spacing: **280 mm**

**Accessories:** see page 20



Wooden single ladder 1052

Length [m]	Number of rungs	Standing height [m]	Stile height [mm]	Weight approx. [kg]	Ref. No.
1.90	6	0.80	65	5.5	1052.206 
2.45	8	1.35	65	7.5	1052.208 
2.99	10	1.85	65	9.5	1052.210 



### Ladder shoe for wooden ladder

DIY-assembly, fits onto ladders 1052 and 1038/1059 up to 10 rungs and onto wallpaperer's trestles 1045

**Ref. No. 1016.052** 

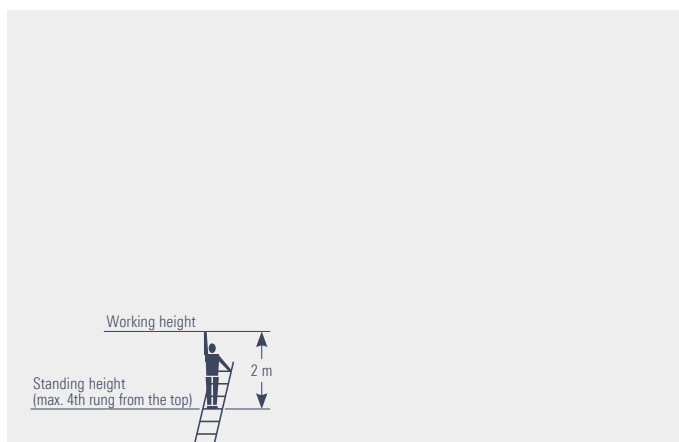

PU = packaging unit  = available ex works  = delivery time on request  = only available in this packaging unit

## Single ladders

### Wooden single ladder for builders 1036

The classic wooden single ladder is ideal for many applications, e.g. rugged use on construction sites.

Stiles and rungs made of narrow-ringed spruce.

Clear width: min. **305 mm**, max. **375 mm**

Outer width at top: **375 mm**

Rung spacing: **280 mm**

Due to its conical design with pointed bar ends, the builder's ladder 1036 does not correspond to a ladder within the meaning of DIN EN 131 and is therefore not subject to cross-piece obligation..



Wooden single ladder for builders 1036

Length [m]	Number of rungs	Standing height [m]	Stile height [mm]	Outer width at bottom [m]	Weight approx. [kg]	Ref. No.
3.00	10	1.85	85	430	11.9	<b>1036.010</b>
4.00	14	2.90	90	450	16.6	<b>1036.014</b>
5.00	17	3.70	95	470	20.2	<b>1036.017</b>
6.00	21	4.75	100	490	25.0	<b>1036.021</b>

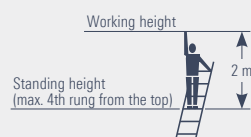

### Combination single ladder 1029

The classic single ladder has remarkable weight advantages thanks to the aluminium rungs which are suitable for regular and continuous use. Ideal for electricians and craftsmen as the ladder is electrically non-conductive. Information on the insulation resistance, in accordance with **VDE 0100**, is available.

Clear width: **300 mm**

Outer width: **354 mm**

Rung spacing: **280 mm**

From a length of 3 m the ladder 1029 does not correspond to the newest version of the DIN EN 131.



Combination single ladder 1029

Length [m]	Number of rungs	Standing height [m]	Stile height [mm]	Weight approx. [kg]	Ref. No.
2.40	8	1.30	75	5.8	<b>1029.008</b>
2.95	10	1.85	75	6.8	<b>1029.010</b>
3.50	12	2.35	75	8.6	<b>1029.012</b>
4.05	14	2.90	75	9.6	<b>1029.014</b>
4.35	15	3.15	75	10.2	<b>1029.015</b>
4.90	17	3.70	75	11.8	<b>1029.017</b>

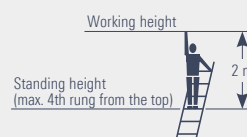

### Extension ladder **TOPIC 1035**

Two-part extension ladder for greater heights, with short transport and storage dimensions. Manual length adjustment rung by rung using engaging hook, secured against lifting out and sliding out of position on transport and use.

- Clear width: **300/377 mm**
- Outer width: **440 mm**
- Rung spacing: **280 mm**
- Cross-piece width: **1130 mm** (to 10 rungs)  
**1360 mm** (from 12 rungs)

The TOPIC 1035 can optionally be equipped with rollers. See page 20.

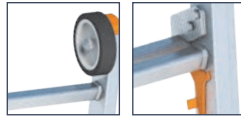

**TIP:**  
With the Layher Combigrip ladder foot, you automatically comply with the new requirements of DIN EN 131-1, which will specify a cross-piece for simple ladders of 3 metres and more length. The Layher Combigrip ladder foot can be quickly and easily retrofitted in TOPIC ladders of earlier generations. Retrofit kits see page 22.



### Rope extension ladder **TOPIC 1037**

For great heights. Always achieve the right working height thanks to rung-by-rung extension. Easy to use rope control, long-life plastic rope, releasing, lowering and securing with automatic drop catch. Rollers with rubber tyre to prevent damage when running up and down walls.



- Clear width: **300/377 mm**
- Outer width: **440 mm**
- Rung spacing: **280 mm**
- Cross-piece width: **1360 mm**

**TIP:**  
With the Layher Combigrip ladder foot, you automatically comply with the new requirements of DIN EN 131-1, which will specify a cross-piece for simple ladders of 3 metres and more length. The Layher Combigrip ladder foot can be quickly and easily retrofitted in TOPIC ladders of earlier generations. Retrofit kits see page 22.

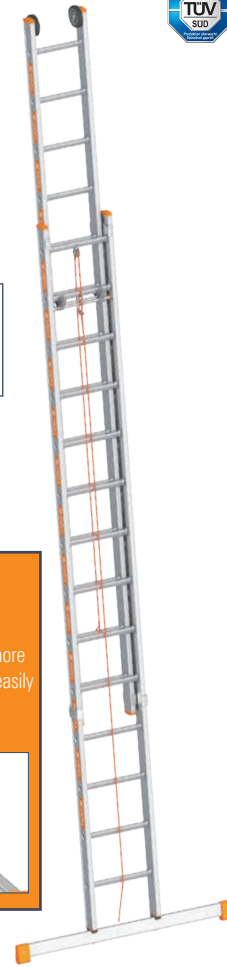

**TOPIC 1035**

Length extend. [m]	Length contr. [m]	Number of rungs	Standing height [m]	Stile height [mm]	Weight approx. [kg]	Ref. No.	
2.95	1.75	2 x 6	1.95	64	7.6	<b>1035.006</b>	
4.05	2.30	2 x 8	3.05	64	12.5	<b>1035.008</b>	ⓘ
5.15	2.85	2 x 10	4.20	76	14.6	<b>1035.010</b>	ⓘ
6.00	3.40	2 x 12	5.05	76	18.4	<b>1035.012</b>	ⓘ
7.10	4.00	2 x 14	6.15	100	22.2	<b>1035.014</b>	ⓘ
8.25	4.55	2 x 16	7.25	100	24.6	<b>1035.016</b>	ⓘ
9.35	5.10	2 x 18	8.40	100v	28.8	<b>1035.018</b>	ⓘ

ⓘ Ladders, highlighted with ⓘ will be delivered ex works with cross-piece.

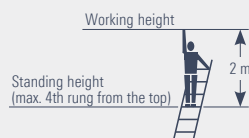

**TOPIC 1037**

Length extend. [m]	Length contr. [m]	Number of rungs	Standing height [m]	Stile height [mm]	Weight approx. [kg]	Ref. No.	
7.10	4.00	2 x 14	6.05	100	23.6	<b>1037.014</b>	ⓘ
8.20	4.55	2 x 16	7.40	100	26.2	<b>1037.016</b>	ⓘ
9.30	5.10	2 x 18	8.05	100	31.0	<b>1037.018</b>	ⓘ
10.15	5.65	2 x 20	9.20	100	34.4	<b>1037.020</b>	ⓘ
11.30	6.20	2 x 22	10.30	100v	37.6	<b>1037.022</b>	ⓘ
12.40	6.80	2 x 24	11.40	100v	41.2	<b>1037.024</b>	ⓘ

ⓘ Ladders, highlighted with ⓘ will be delivered ex works with cross-piece.

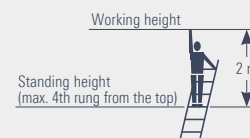

PU = packaging unit   📦 = available ex works   ⓘ = delivery time on request   📦 = only available in this packaging unit

## Double ladders

### Double rung ladder **TOPIC 1039**



The traditional double ladder with a wide range of safety features: **Plastic-sheathed steel hinges**, tear-proof polyester straps to prevent over-spreading, slip-resistant plastic shoes. Additional stiffeners at the end of the stile ensure that the values specified in DIN EN 131 are bettered.

Rung spacing: **280 mm**



#### TOPIC 1039

Length [m]	Standing height [m]	Number of rungs	Stile height [mm]	Outer width at bottom [m]	Weight approx. [kg]	Ref. No.
1.30	0.55	4	64	0.48	6.0	<b>1039.004</b>
1.55	0.80	5	64	0.51	6.8	<b>1039.005</b>
1.85	1.05	6	64	0.54	8.0	<b>1039.006</b>
2.10	1.30	7	64	0.57	9.2	<b>1039.007</b>
2.40	1.60	8	64	0.60	10.4	<b>1039.008</b>
2.70	1.85	9	64	0.62	12.0	<b>1039.009</b>
2.95	2.10	10	64	0.66	13.2	<b>1039.010</b>
3.50	2.65	12	64	0.72	16.0	<b>1039.012</b>
4.10	3.15	14	64	0.78	18.8	<b>1039.014</b>
4.65	3.70	16	76	0.84	24.9	<b>1039.016</b>
5.20	4.20	18	76	0.90	30.1	<b>1039.018</b>

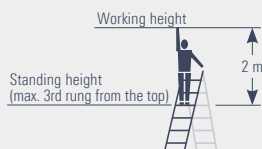

### Stairway double ladder **TOPIC 1061**

The professional solution not just for stairways. With the stairway double ladder, level equalization on uneven surfaces or stairways is no problem. The sturdy design and well thought-out details ensure optimum handling.

The stile extensions permanently attached to the ladder are quick to lock and easy to use thanks to rotary knobs fitted on the inside of the stile.

The stile extensions have an adjustment range of 40 cm on one side and of 102 cm on the other side.

Rung spacing: **280 mm**



#### TOPIC 1061

Length [m]	Standing height [m]	Number of rungs	Stile height [mm]	Outer width at bottom [m]	Weight approx. [kg]	Ref. No.
1.55	0.80	5	64	0.51	12.3	<b>1061.005</b>
1.85	1.05	6	64	0.54	13.5	<b>1061.006</b>
2.10	1.30	7	64	0.57	14.7	<b>1061.007</b>
2.40	1.60	8	64	0.60	15.9	<b>1061.008</b>

\* with stiles not extended



#### Suspended step

Ref. No. **1016.003**



#### TOPIC-Box

Ref. No. **1016.021**

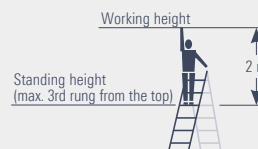

## Combination double ladder 1028

The wood / aluminium ladder, tried, tested and praised by craftsmen. Ideal for electricians and craftsmen, as it is not electrically conductive. Information on the insulation resistance, in accordance with **VDE 0100** is available.

Sturdy and torsion-stiff design. Extra-strong steel hinges, tear-proof polyester straps to prevent over-spreading.

Rung spacing: **280 mm**



Combination double ladder 1028

Length [m]	Standing height [m]	Number of rungs	Stile height [mm]	Outer width at bottom [m]	Weight approx. [kg]	Ref. No.	
1.55	0.80	5	75	0.50	7.6	<b>1028.005</b>	
1.80	1.05	6	75	0.53	9.0	<b>1028.006</b>	
2.10	1.30	7	75	0.56	11.0	<b>1028.007</b>	
2.40	1.60	8	75	0.59	12.6	<b>1028.008</b>	
2.95	2.10	10	75	0.65	16.0	<b>1028.010</b>	
3.50	2.65	12	75	0.71	19.2	<b>1028.012</b>	



Suspended bag  
Ref. No. 1016.014

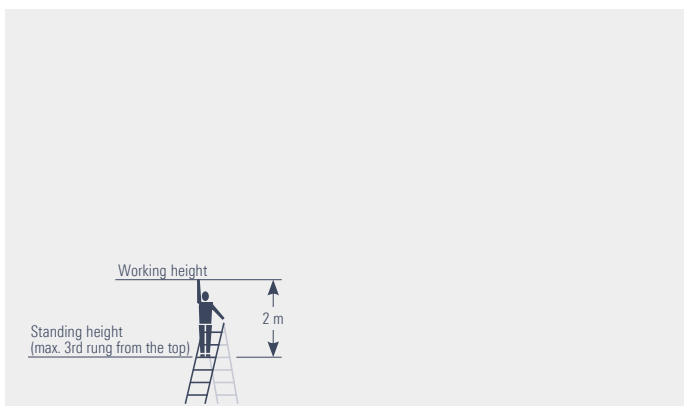

## Wooden double ladder 1038/1059.2

The classic craftsman's ladder. Access from either side and complete with tool bag, over-spreading prevented by 2 polyester straps, adjustable clamping pins, sturdily designed and galvanized steel hinges with bucket hook, metal catch at bottom of ladder to secure it during transport. Stiles of solid red pine. Rungs made of sturdy beechwood. Thanks to the special square-section studs and a special gluing process, a durable and permanent connection between stile and rung is achieved.



Rung spacing: **280 mm**  
Rung dimensions: **44 x 22 mm**

### Wooden double ladder with wide rungs 1059

As for Model 1038, but with 44 mm wide grooved rungs (3rd and 4th rung from the top per side) for comfortable and safe standing.



Accessories:  
see page 20

Wooden double ladder 1038

Length [m]	Standing height [m]	Number of rungs	Stile height [mm]	Outer width at bottom [m]	Weight approx. [kg]	Ref. No.	
1.00	0.30	3	65	0.47	5.7	<b>1038.203</b>	
1.25	0.55	4	65	0.50	7.4	<b>1038.204</b>	
1.50	0.80	5	65	0.53	8.9	<b>1038.205</b>	
1.85	1.05	6	65	0.56	10.4	<b>1038.206</b>	
2.10	1.30	7	65	0.59	12.5	<b>1038.207</b>	
2.35	1.60	8	65	0.62	14.3	<b>1038.208</b>	
2.65	1.85	9	65	0.65	15.7	<b>1038.209</b>	
2.95	2.10	10	65	0.68	17.5	<b>1038.210</b>	
3.50	2.65	12	70	0.74	25.5	<b>1038.212</b>	
4.10	3.15	14	70	0.80	30.0	<b>1038.214</b>	

Wooden double ladder with wide rungs 1059.2

Length [m]	Standing height [m]	Number of rungs	Stile height [mm]	Outer width at bottom [m]	Weight approx. [kg]	Ref. No.	
1.25	0.55	4	65	0.50	8.0	<b>1059.204</b>	
1.50	0.80	5	65	0.53	9.5	<b>1059.205</b>	
1.85	1.05	6	65	0.56	11.0	<b>1059.206</b>	
2.10	1.30	7	65	0.59	13.1	<b>1059.207</b>	
2.35	1.60	8	65	0.62	14.9	<b>1059.208</b>	
2.65	1.85	9	65	0.65	16.3	<b>1059.209</b>	
2.95	2.10	10	65	0.68	18.1	<b>1059.210</b>	
3.50	2.65	12	70	0.74	26.1	<b>1059.212</b>	
4.10	3.15	14	70	0.80	30.6	<b>1059.214</b>	

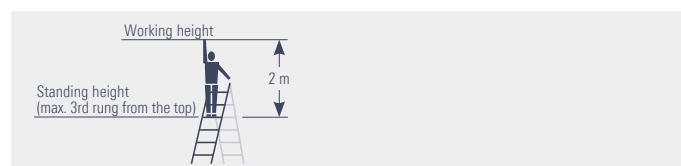

PU = packaging unit = available ex works = delivery time on request = only available in this packaging unit

## Double ladders

### Wooden double ladder acc. to Ö-Norm Z1501 1053

The both side accessible wooden ladder for special professional use. It contains ergonomic needs of painters, wallpaperers while long standing on the rungs. The ladders according to the additional Austrian standard Z1501 are made accordingly to EN 131-1 and -2, excepting the two top rung spacings. They are 320 mm for comfortable standing on the ladder.

The configuration is the same as the wooden double ladder 1038  
Rung spacing: **280 and 320 mm**

AUVA approved

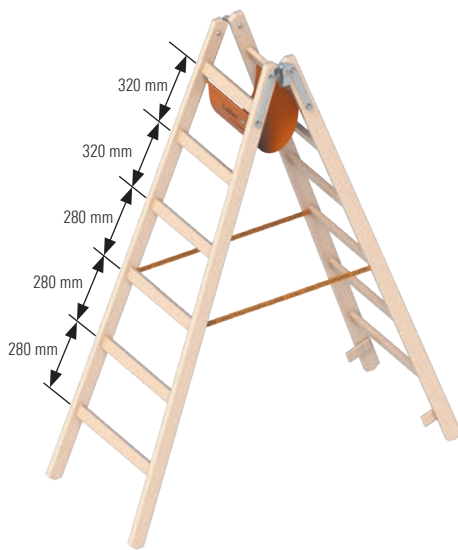

Wooden double ladder 1053 acc. to Ö-Norm

Length [m]	Standing height [m]	Number of rungs	Stile height [mm]	Outer width at bottom [m]	Weight approx. [kg]	Ref. No.
1.05	0.30	3	65	0.50	6.2	1053.203
1.30	0.55	4	65	0.53	7.4	1053.204
1.60	0.80	5	65	0.56	9.2	1053.205
1.90	1.05	6	65	0.58	10.7	1053.206
2.15	1.30	7	65	0.61	12.8	1053.207
2.45	1.60	8	65	0.64	14.6	1053.208
2.70	1.85	9	65	0.67	16.0	1053.209
3.00	2.10	10	65	0.70	17.8	1053.210
3.30	2.30	11	70	0.73	23.3	1053.211
3.55	2.65	12	70	0.76	25.8	1053.212

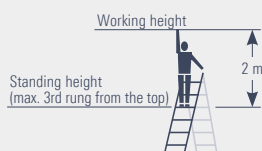

### Double step ladder TOPIC 1043



The classic double ladder design with comfortable and wide steps. **Plastic-sheathed steel hinges**, angle reinforcements and tear-proof polyester straps are quality features. The two top steps make up a platform.

Step spacing: **250 mm**  
Step width: **80 mm**  
Stile height: **76 mm**



TOPIC 1043

Length [m]	Standing height [m]	Number of rungs	Max. load [kg]	Outer width at bottom [m]	Weight approx. [kg]	Ref. No.
0.75	0.25	3	300	0.46	5.6	1043.003
1.00	0.50	4	300	0.48	6.8	1043.004
1.25	0.70	5	300	0.51	8.4	1043.005
1.50	0.95	6	250	0.53	9.8	1043.006
1.75	1.20	7	250	0.57	11.4	1043.007
2.00	1.40	8	250	0.60	13.4	1043.008
2.50	1.90	10	200	0.66	16.2	1043.010
3.00	2.40	12	200	0.72	19.8	1043.012



TOPIC-Box  
Ref. No. 1016.021

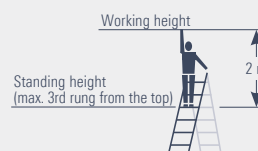

### Double step ladder with access on one side **TOPIC 1064**

A safe stance at all times from the platform, extended stiles and knee bar shaped as a storage tray. The amply dimensioned platform folds up for transport. Tear-proof polyester straps to prevent over-spreading.

Step spacing: **250 mm**  
Step width: **80 mm**



**TOPIC 1064**

Length [m]	Standing height [m]	Number of rungs	Stile height [mm]	Outer width at bottom [m]	Weight approx. [kg]	Ref. No.	
1.40	0.70	3	76	0.46	6.2	<b>1064.003</b>	📦
1.70	0.95	4	76	0.48	7.0	<b>1064.004</b>	📦
1.95	1.20	5	76	0.51	8.0	<b>1064.005</b>	📦
2.20	1.40	6	76	0.53	9.2	<b>1064.006</b>	📦
2.45	1.65	7	76	0.57	10.4	<b>1064.007</b>	📦
2.70	1.90	8	76	0.60	11.6	<b>1064.008</b>	📦
2.95	2.10	9	76	0.64	13.2	<b>1064.009</b>	📦
3.20	2.35	10	76	0.66	14.0	<b>1064.010</b>	📦
3.70	2.80	12	76	0.72	16.4	<b>1064.012</b>	📦

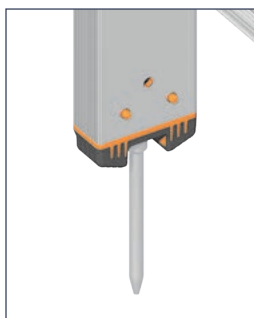

**Combigrisp spikes**  
DIY-assembly

**Ref. No. 1016.099** 📦

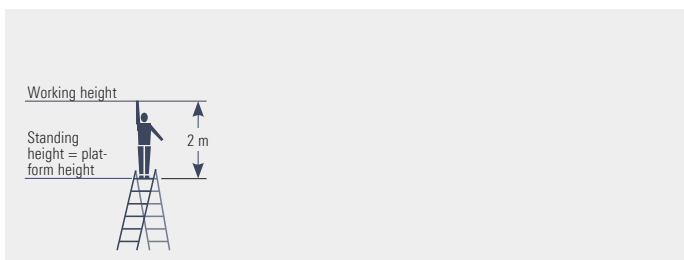

### Folding ladder **TOPIC 1056**

The Layher Folding Ladder **TOPIC 1056** is the perfect choice if you're using a double ladder that can be turned quickly and easily into a simple ladder. Strong and securely engaging steel joints ensure the required working position. For optimum stability, the Layher Folding Ladder is fitted on one side with an 890 mm wide cross-piece.

All-round grooved triangular rungs, quadruple-folded with the stile, ensure comfortable and sure footing at all times.

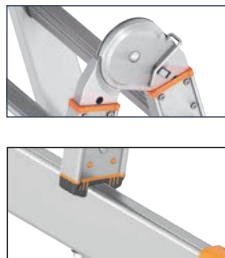

Rung spacing: **280 mm**  
Outer width: **395 mm**  
Stile height: **64 mm**  
Cross-piece width: **890 mm**

**Assembly variants**



**TOPIC 1056**

Max. length [m]	Min. length [m]	Standing height double ladders [m]	Standing height single ladders [m]	Number of rungs	Weight approx. [kg]	Ref. No.
2.47	1.25	0.80	1.32	2 x 4	7.8	<b>1056.008</b> 📦
3.59	1.80	1.34	2.37	2 x 6	9.5	<b>1056.012</b> 📦
4.71	2.36	1.90	3.42	2 x 8	11.6	<b>1056.016</b> 📦



**Suspension hook**  
DIY-assembly

**Ref. No. 1016.050**

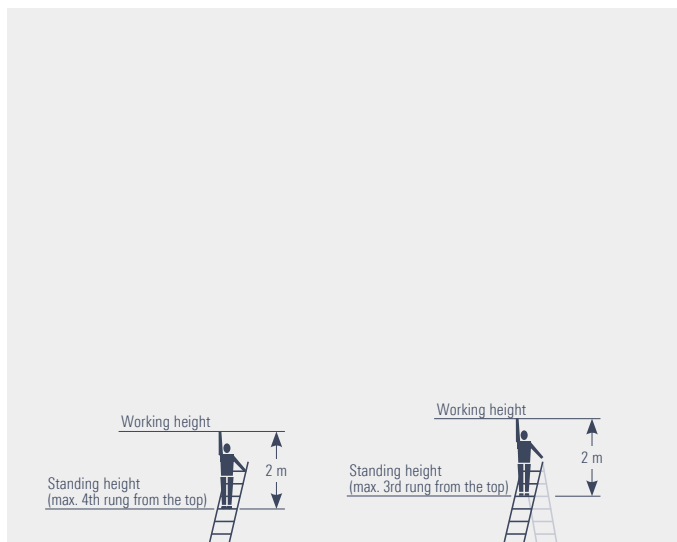

PU = packaging unit 📦 = available ex works 🕒 = delivery time on request 📦 = only available in this packaging unit

## Multifunction ladders

### Car boot ladder TOPIC 1057

For very low transport and storage dimensions. Very versatile in use. As double ladder, single ladder, single ladder with wall clearance and as working platform (only with deck). Safety joints automatically lock but are released with slight pressure.

Standing height as working platform: **0.89 m**

**Note: The 1057.116 cannot be used as a working platform.**

Stile height: **64 mm**  
Rung spacing: **280 mm**  
Outer width: **395 mm**  
Cross-piece width: **620 mm**

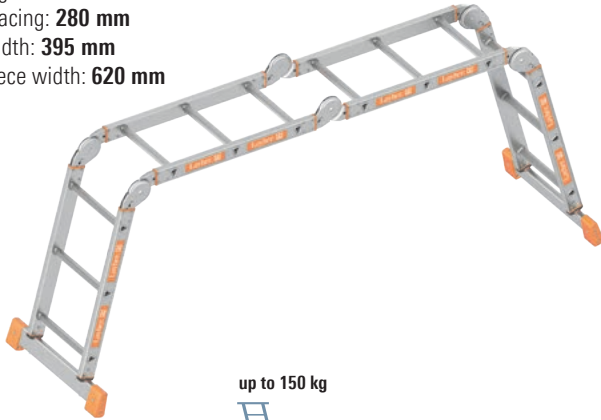

#### Assembly variants

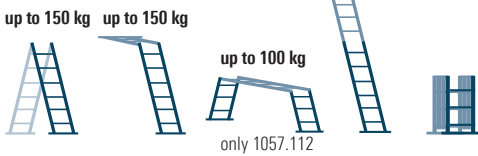

#### TOPIC 1057

Max. length [m]	Standing height single ladder [m]	Standing height single ladder with wall clearance [m]	Standing height double ladder [m]	Number of rungs	Weight approx. [kg]	Ref. No.
3.43	2.29	1.52	1.00	4 x 3	14.5	<b>1057.112</b>
4.55	3.34	2.56	1.54	4 x 4	16.5	<b>1057.116</b>

#### Transport/packaging dimensions:

**1057.112** 0.91 x 0.63 x 0.29 m  
**1057.116** 1.20 x 0.89 x 0.29 m



#### Platform for 1057.112

Weight approx. [kg]	Art.-Nr.
3.5	<b>1057.100</b>

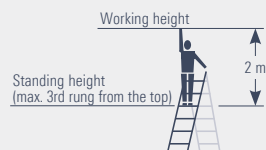
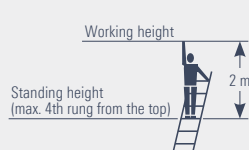
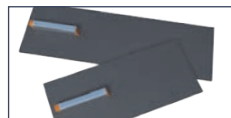

### All-purpose ladder 3-part TOPIC 1040

Options to use as an extension ladder, single ladder, double ladder or extendable double ladder – all possible thanks to special joints. Safe free standing of ladder thanks to cross-piece. Aluminium stiffener with pushbutton locking. Also the assembly is done within only a few second. Manual length adjustment rung by rung using engaging hook. Secured against lifting out and sliding out of position. Easy handling in all variants. Securing flaps prevent a lateral movement of the ladder pieces while carrying. The TOPIC 1040 can optionally be equipped with rollers. See page 20.

Clear width: **454/377/300 mm**  
Rung spacing: **280 mm**

Cross-piece width: **890 mm** with 6 – 8 rungs  
Cross-piece width: **1130 mm** with 10 rungs  
Cross-piece width: **1370 mm** with 12 rungs  
Cross-piece width: **1600 mm** with 14 rungs

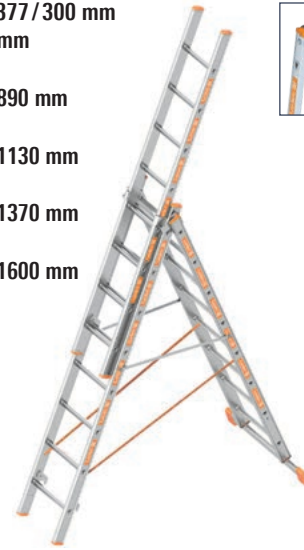

#### Assembly variants



#### TOPIC 1040

Max. length [m]	Min. length [m]	Standing height double ladder [m]	Standing height top section extended [m]	Standing height extension ladder [m]	Number of rungs	Stile height [mm]	Weight approx. [kg]	Ref. No.
4.15	1.90	1.05	1.60	2.85	3 x 6	76	15.6	<b>1040.006</b>
5.25	2.45	1.55	2.10	3.90	3 x 8	76	19.5	<b>1040.008</b>
6.65	3.00	2.05	3.15	5.20	3 x 10	76	23.2	<b>1040.010</b>
8.35	3.55	2.55	4.20	6.80	3 x 12	100	31.7	<b>1040.012</b>
10.05	4.15	3.05	5.25	8.35	3 x 14	100	35.5	<b>1040.014</b>

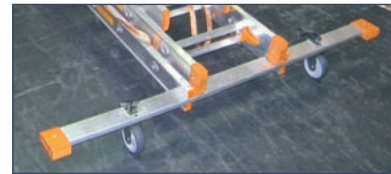

For easier transporting and carrying the ladder, the cross-piece can be equipped with cross-piece castors.

**Art.-Nr. 1016.069** pair

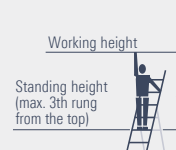
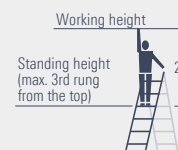
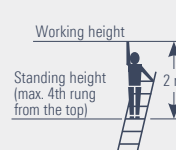



## Telescopic ladder TOPIC 1058

Very versatile in use: as double ladder with variable height adjustment on one side. As a classic single ladder. And as two separate work trestles. Manual length adjustment rung by rung. Sturdy pin joints secure the ladder in the appropriate setting for use.

The standing width of the TOPIC 1058 does not correspond to the latest version of the DIN EN 131

Rung spacing: **280 mm**  
Stile height: **64 mm**

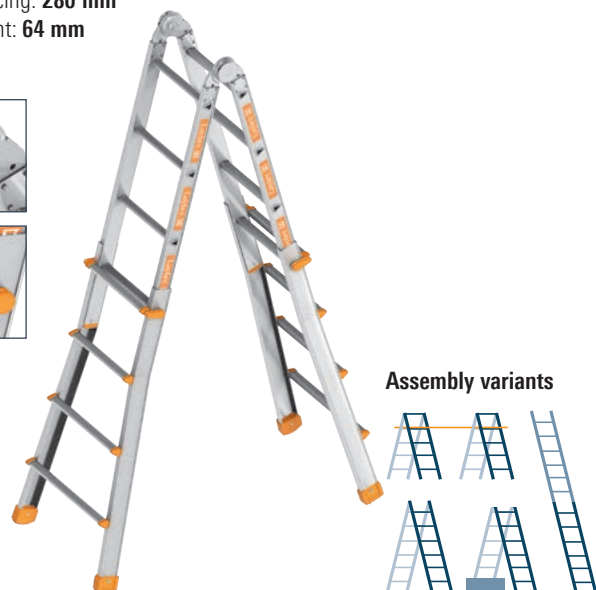

**TOPIC 1058**

Max. Length [m]	Standing height double ladder [m]	Standing height single ladder [m]	Number of rungs	Weight approx. [kg]	Ref. No.
4.16	1.35	3.05	4 x 4	14.0	<b>1058.016</b>
5.27	1.90	4.10	4 x 5	17.0	<b>1058.020</b>
6.42	2.45	5.15	4 x 6	20.5	<b>1058.024</b>

### Transport/packaging dimensions:

**1058.016:** 1.34 x 0.50 x 0.23 m  
**1058.020:** 1.61 x 0.53 x 0.23 m  
**1058.024:** 1.85 x 0.67 x 0.23 m

### Stile extension

Usable as stile extension and as a cross-piece.  
Max. permissible stile extension: 450 mm

Weight approx. [kg]	Ref. No.
1.6	<b>1058.001</b>



## Alu telescopic stage 1351

The Alu telescopic stage offers a wide and variable range of possible applications. For transport, the telescopic stage can be simply pushed together, resulting in low transport dimensions. Since the Alu telescopic stage is extendable, it can be pulled out or pushed together to provide any required length.

The automatic locking mechanism ensures that the inner extending element cannot slide out by mistake. The supporting structure is made of specially developed and torsion-stiff extruded aluminium sections.

All section ends are provided with plastic caps. They act as sliding elements and provide protection from injury. Thanks to these plastic sliding elements, the effort required to slide the telescopic stage in and out is very low.

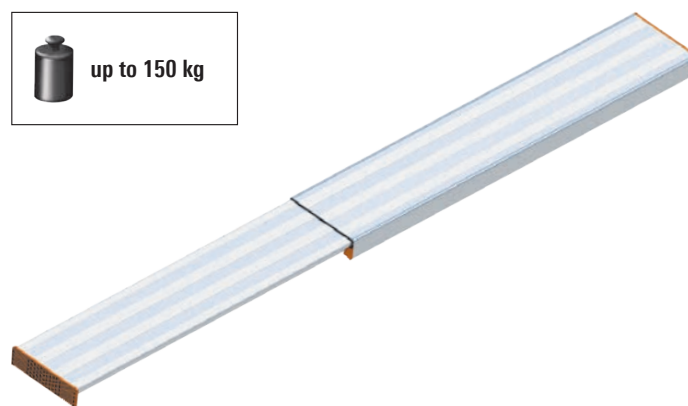

**Alu telescopic stage 1351**

Max. length [m]	Min. length [m]	Width [m]	Height [m]	Weight approx. [kg]	Ref. No.
2.90	1.64	0.31	0.08	13.0	<b>1351.290</b>
3.50	1.92	0.31	0.08	16.0	<b>1351.350</b>
4.00	2.27	0.31	0.08	18.0	<b>1351.400</b>
4.40	2.49	0.31	0.08	20.0	<b>1351.440</b>

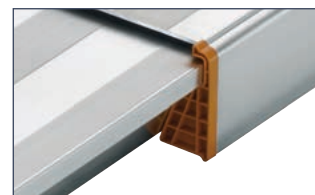

## Platform ladder

### Platform ladder **TOPIC 1074**

The **TOPIC 1074** platform ladder for access from one side is a comfortable aid to doing lengthy work on the ladder. The large 480 x 420 mm platform using a non-slip grooved metal plate ensures a sure footing particularly for lengthy work on the ladder. Handrails fitted to the stile on both sides permit a safer grip when climbing up and down the ladder.



The holding device fitted 1 metre above the platform can also double as a tool storage tray.



A pressure-resistant over-spreading preventer between the access side and the supporting side prevents accidental collapse when climbing up and down the ladder.



The aluminium handrails can be quickly and easily folded inwards without using tools. That means you save not only time, but also space when storing and transporting it, and no small parts can be lost.



When the optional cross-piece rollers are used, the ladder can be quickly and easily repositioned in the horizontal direction. The ladder is immediately usable again – for faster and more efficient work.



#### TOPIC 1074

Length [m]	Standing height [m]	Number of rungs	Weight approx. [kg]	Ref. No.	
2.10	0.90	4	12.0	<b>1074.004</b>	
2.40	1.20	5	13.2	<b>1074.005</b>	
2.60	1.40	6	14.5	<b>1074.006</b>	
2.80	1.60	7	15.6	<b>1074.007</b>	
3.10	1.90	8	16.3	<b>1074.008</b>	



For easier transporting and carrying the ladder, the cross-piece can be equipped with cross-piece castors.

**Art.-Nr. 1016.069**   
pair

#### YOUR BENEFITS AT A GLANCE

- ▶ Ample sized platform for comfortable and fatigue-free work – even over lengthy periods.
- ▶ Handrails fitted to the stile on both sides for a safer grip when climbing up and down the ladder – folding inwards for transport.
- ▶ Two-part aluminium storage tray as a holder for separate storage of tools and fastening materials.
- ▶ Cross-pieces on both sides widen the base of the ladder to increase its stability during use.
- ▶ Long life, much appreciated by customers, thanks to the Layher TOPIC quality features.

## Alu heavy-duty step TOPIC 1043.3

The classic step design with comfortable and wide steps.  
**Plastic-sheathed steel hinges**, angle reinforcements and tear-proof polyester straps are quality features. The platform at the top can be footed.



Step spacing: **250 mm**  
Step width: **80 mm**  
Stile height: **76 mm**  
Platform dimensions: **480 mm x 285 mm**



TOPIC 1043.3

Length [m]	Standing height [m]	Number of rungs	Outer width at bottom [m]	Weight approx. [kg]	Ref. No.
0.91	0.71	3	0.64	8.4	1043.303
1.16	0.95	4	0.65	9.6	1043.304



The platform has a practical grip hole for easy transport.

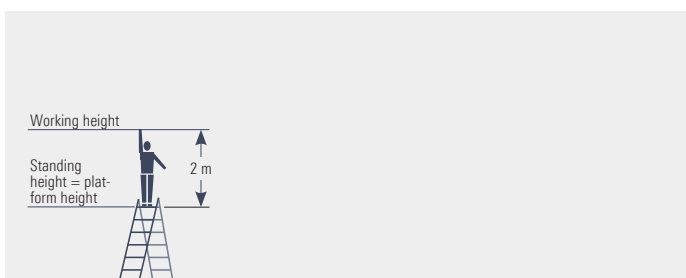

## Folding wooden steps 1055

Steps with access on one side for fitting and servicing work. Ideal for plasterers, drywall installers and painters. Amply sized standing surface and wide steps for safe and comfortable working. For ease of transport, a practical grip hole has been cut out from the standing surface. Protection against over-spreading made of galvanized steel. Stiles made of narrow-ringed yellow pine. Grooved steps made of sturdy beechwood.

Step spacing: **22 mm**  
Step width: **110 mm**  
Platform dimension: **215 x 565 mm**  
Outer width: **565 mm**

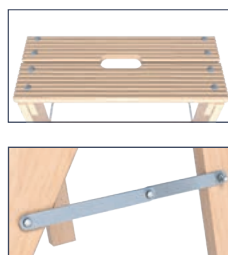

Folding wooden steps 1055

Length [m]	Standing height [m]	Number of rungs	Width when unfolded [m]	Outer width at bottom [m]	Weight approx. [kg]	Ref. No.
0.78	0.65	3	0.68	0.62	6.8	1055.003
1.05	0.87	4	0.85	0.64	8.5	1055.004

## Wallpaperer's trestle 1045

The sturdy structure for the professional user.  
Sturdy, galvanized steel hinges.  
Stiles made of pine wood and rungs made of solid beechwood.

Support strip: **650 mm**



Wallpaperer's trestle 1045

Length [m]	Number of rungs	Width when unfolded [m]	Outer width at bottom [m]	Support height [m]	Weight approx. [kg]	Ref. No.
0.84	2	0.76	0.61	0.80	4.4	1045.202
0.98	3	0.82	0.61	0.95	5.2	1045.203

PU = packaging unit   = available ex works   = delivery time on request   = only available in this packaging unit

# Accessories

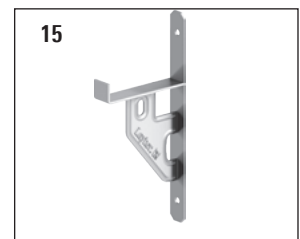
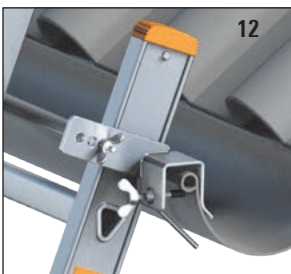
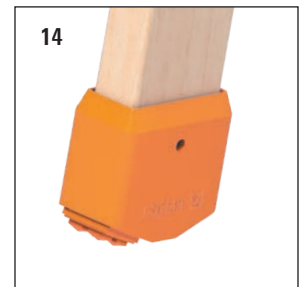
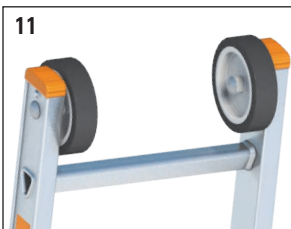
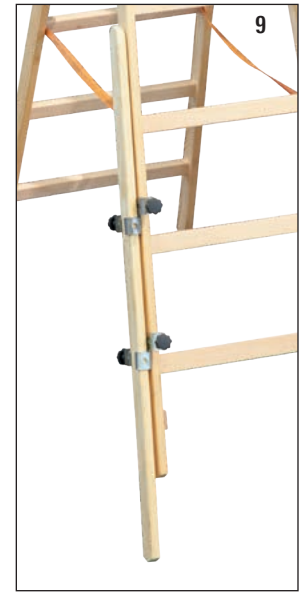
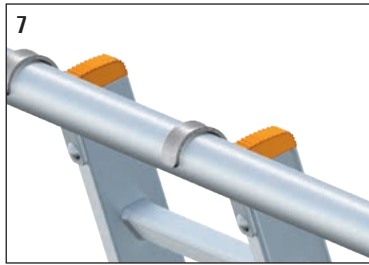
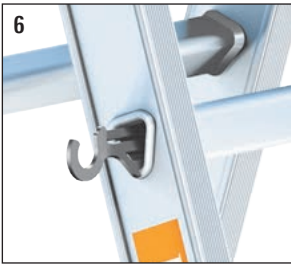
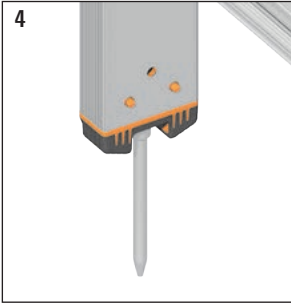
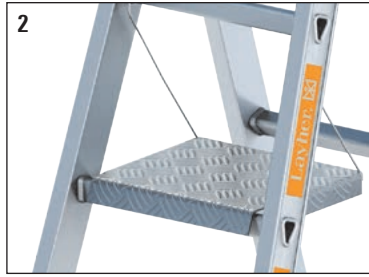

Pos.	Description	Dimensions [m]	Weight approx. [kg]	PU	Ref. No.	1054	1042	1060	1052	1036	1029	1035	1037	1039	1061	1028	1038	1043	1064	1045	1055	1043.3	1056	1057	1040	1058	1074		
1	<b>TOPIC Box</b> for use on all TOPIC rung or double step ladders; easy fitting over the rungs or steps		0.8		<b>1016.021</b>																								
2	<b>Suspended step</b> for use on all TOPIC rung ladders; easy fitting over the rungs		0.8		<b>1016.003</b>																								
3	<b>TOPIC Stile Extension</b> for stile extension on stairways or podia; adjustment area up to 400 mm; easy fitting by 2 large dimensioned wing bolts	64 mm	1.5		<b>1016.108</b> 📦																								
		76 mm	1.7		<b>1016.109</b> 📦																								
		84 mm	1.9		<b>1016.110</b> 📦																								
		100 mm	2.1		<b>1016.111</b> 📦																								
4	<b>Spike</b> For better stability on grass or soil; easy fitting without drilling or riveting. Usable on all TOPIC ladders with Combigrrip ladder foot.		0.2	2 📦	<b>1016.099</b> 📦																								
5	<b>Suspended bag with hook</b> as tool box for all TOPIC rung double ladders		0.5		<b>1016.014</b>																								
6	<b>Insert hook</b> self-securing, usable on all Layher TOPIC ladders		0.1		<b>1016.100</b>																								
7	<b>Suspension hook</b> DIY-assembly, usable on shafts up to dia. 50 mm		0.1		<b>1016.050</b>																								
8	<b>Wall bracket</b> for easy suspension of ladders with suspension hooks		2.5		<b>1016.090</b> 📦																								
9	<b>Wood stile extension set EasyFix</b> for wooden double ladders 1038 and 1059 (up to 10 rungs) and the wallpaperer's trestle 1045, fixation material with wing bolts included	1.25	1.9		<b>1016.022</b> 📦																								
		1.65	2.2		<b>1016.023</b> 📦																								
10	<b>Cross-piece castors</b> for easy movement of large ladders; easy fitting by large dimensioned wing bolts		1.4	2 📦	<b>1016.069</b> 📦	usable for all ladders with cross-piece																							
11	<b>Top rollers</b> with rubber tyres to protect the wall surface when extending / retracting ladder, usable on the TOPIC ladders 1035, 1037 and 1040		1.5	2 📦	<b>1016.027</b> 📦																								
12	<b>Gutter holder</b> Secure attachment for all ladders		0.5		<b>1016.006</b>																								
13	<b>Window cleaner extension</b> usable for all Layher rung ladders, easy plug on and securing		3.5		<b>1016.091</b> 📦																								
14	<b>Ladder shoe for wooden ladder</b> DIY -assembly, fits onto ladders 1052 and 1038 / 1059 up to 10 rungs and onto wallpaperer's trestles 1045		0.5	2 📦	<b>1016.052</b> 📦																								
15	<b>Ladder wall mounting</b> for an ideal storage of ladders on the wall		1.8		<b>1016.092</b> 📦																								

PU = packaging unit 📦 = available ex works 🕒 = delivery time on request 🏠 = only available in this packaging unit

## Spare parts

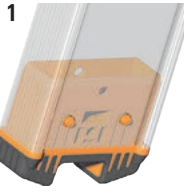

The Layher Combigrip ladder foot is made of a 2-component plastic: a hard inner section (orange) for secure mounting inside the stile, and a soft outer covering (black), non-slip on every floor surface.

That ensures:

- ▶ play-free mounting in ladder stile
- ▶ high slipping resistance, for maximum stability of ladders
- ▶ long service life – no cutting or reshaping of the foot

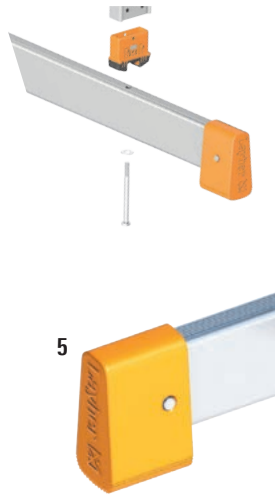

The Layher Combigrip ladder foot ensures easy retrofitting of a ladder cross-piece.

The cross-piece is simply inserted into the cutout provided for it in the foot, and then firmly screwed to the stile ends using hexagonal-head screws.

**TIP:** With the Layher Combigrip ladder foot, you automatically comply with the new requirements of DIN EN 131-1, which will specify a cross-piece for simple ladders of 3 metres and more length.



## Pictogram description

Labels acc. to new DIN EN 131-3 – label see pos. 7

<p>Pay attention to the user manual</p>	<p>Do not use the ladder on an uneven, unstable or fouled surface.</p>	<p>Only ascend and descend the ladder when facing towards it. Grip the ladder tightly during ascent, descent and working.</p>
<p>Check ladder upon delivery. Visually check the ladder for absence of damage and for safe use prior to every use. Do not use damaged ladders.</p>	<p>Do not use the ladder on an uneven, unstable or fouled surface.</p>	<p>Only ascend and descend the ladder when facing towards it. Grip the ladder tightly during ascent, descent and working.</p>
<p>Remain below the maximum useful load.</p>	<p>Open the ladder completely before use. Locking devices must be fully activated before the ladder is used, if this is not done automatically.</p>	<p>Do not use the top three steps / rungs of a simple ladder to stand on.</p>
<p>Only use the ladders with the included cross-pieces.</p>	<p>max.</p>	<p>Do not use the top two steps / rungs of a double ladder to stand on without a platform and a holding device for the hand / knee</p>
<p>Use simple ladders with rungs at the correct angle.</p>	<p>max.</p>	<p>Do not use the top two steps / rungs of a double ladder to stand on without a platform and a holding device for the hand / knee</p>
<p>Do not exceed the maximum number of users.</p>	<p>max.</p>	<p>Ladders with this marking are designed for private use only.</p>
<p>Do not use the ladder for bridging purposes.</p>	<p>Avoid any work exerting a lateral load on the ladder, for example drilling sideways through solid materials. When using a ladder, do not carry equipment which is heavy and awkward.</p>	<p>Ladders with this marking are designed for private use only.</p>
<p>Ladders for access to greater heights must be extended at least 1 metre above the contact point and secured as necessary</p>	<p>Avoid any work exerting a lateral load on the ladder, for example drilling sideways through solid materials. When using a ladder, do not carry equipment which is heavy and awkward.</p>	<p>Ladders with this marking are designed for both private and professional use.</p>
	<p>Avoid any work exerting a lateral load on the ladder, for example drilling sideways through solid materials. When using a ladder, do not carry equipment which is heavy and awkward.</p>	<p>Ladders with this marking are designed for both private and professional use.</p>

Pos.	Description	Dimensions [m]	Weight approx. [kg]	PU	Ref. No.	
1	<b>Combigrip ladder foot</b> of 2-component plastic for secure mounting inside the stile and non-slip on every floor surface.	64-mm-stile	0.2	2	6492.810	
		76-mm-stile	0.2	2	6492.811	
		84-mm-stile	0.2	2	6492.812	
		100-mm-stile	0.2	2	6492.813	
2	<b>TOPIC ladder foot</b> for ladder heads and inner ladders of multi-purpose ladders	64-mm-stile	0.1	2	6492.011	
		76-mm-stile	0.2	2	6492.012	
		84-mm-stile	0.2	2	6492.013	
		100-mm-stile	0.2	2	6492.014	
3	<b>Ladder cross-piece</b> for even more safety, easy fitting with the Combigrip ladder foot	1054.006 – 1054.024 1042.006 – 1042.016	1.13	3.0	1016.081	
		1035.006 – 1035.010	0.89	3.0	1016.082	
		1035.012 – 1035.018	1.36	3.0	1016.084	
		1037.014 – 1037.024				
4	<b>Ladder control book</b> acc. to UVV "Ladders and steps" BGV D 36 § 29, ladders and steps must be checked to their proper condition. By the ladder control book you have a check list for controlling and protocolling.	<a href="https://downloads.layher.com">downloads.layher.com</a>				
5	<b>Foot for cross-piece</b> for all ladder cross-pieces		0.5	2	6492.015	
6	<b>Check plaque</b> German operating safety regulations require that ladders are inspected		0.01	10	6492.160	
7	<b>Universal label</b> acc. to DIN EN 131 instructions for assembly and use must be affixed visibly to each ladder.		0.01	10	6492.165	
8	<b>Retrofit kit</b> Ladder cross-piece including Combigrip ladder foot	1054.006 – 1054.018	1.13	3.2	1016.681	
		1054.020 – 1054.022, 1042.006 – 1042.016,	1.13	3.2	1016.781	
		1054.024	1.13	3.2	1016.881	
		1035.006 – 1035.008	0.89	3.2	1016.682	
		1035.010	0.89	3.2	1016.782	
		1035.012	1.37	3.2	1016.784	
		1035.014, 1037.014	1.37	3.2	1016.884	
		1035.016 – 1035.018 1037.016 – 1037.024	1.37	3.2	1016.184	

PU = packaging unit    = available ex works    = delivery time on request    = only available in this packaging unit

## Roof ladders

### Roofer's ladder 1046

Special ladder in craftsman's quality, curved rungs with recesses for roof hooks.

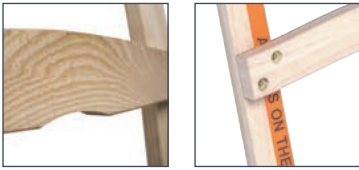

Double-screwed to stiles. In conformity with the regulations of German professional builders' associations.

The roofer's ladder 1046 permit a variable operating range up to a roof pitch of 75° and hung in roof hooks.

The roofer's ladder 1046 ist equipped with tear-proof polyester straps as breaking cut-out.

Outer width: **365 mm**  
Rung spacing: **280 mm**



### Roof ladder acc.to DIN 18160-5 1051



Layher roof ladders are permanently attached to the house roof to enable safe access at all times for recurring maintenance work, e.g. on chimneys or satellite dishes.



High-grade roofs are protected from scratching during assembly and use by the unique and EPDM protective section of Layher roof ladders. Layher roof ladders permit a variable operating range up to a roof pitch of 73°. They are in conformity with DIN 18160-5.

The Layher roof ladders are available in 4 colour variants:

- ▶ Natural aluminium
- ▶ RAL 7016 (Anthracite grey)
- ▶ RAL 8004 (Copper brown)
- ▶ RAL 8011 (Nut brown)

Clear width: **300 mm**  
Rung spacing: **280 mm**  
Stile height: **95 mm**



#### Roofer's ladder 1046

Stile height [m]	Number of rungs	Weight approx. [kg]	Ref. No.
2.30	8	4.8	<b>1046.108</b>
2.85	10	5.5	<b>1046.110</b>
3.40	12	6.3	<b>1046.112</b>
3.95	14	7.0	<b>1046.114</b>
4.50	16	7.8	<b>1046.116</b>
5.05	18	9.2	<b>1046.118</b>

#### 1051

Length [m]	Width [m]	Number of rungs	Colour	Weight approx. [kg]	Ref. No.
1.96	0.34	7	Aluminium nat.	3.8	<b>1051.007</b>
2.80	0.34	10	Aluminium nat.	5.5	<b>1051.010</b>
4.20	0.34	15	Aluminium nat.	8.3	<b>1051.015</b>
1.96	0.34	7	RAL 8004	3.8	<b>1051.107</b>
2.80	0.34	10	RAL 8004	5.5	<b>1051.110</b>
4.20	0.34	15	RAL 8004	8.3	<b>1051.115</b>
1.96	0.34	7	RAL 8011	3.8	<b>1051.207</b>
2.80	0.34	10	RAL 8011	5.5	<b>1051.210</b>
4.20	0.34	15	RAL 8011	8.3	<b>1051.215</b>
1.96	0.34	7	RAL 7016	3.8	<b>1051.307</b>
2.80	0.34	10	RAL 7016	5.5	<b>1051.310</b>
4.20	0.34	15	RAL 7016	8.3	<b>1051.315</b>



Connect the roof ladders using the connecting straps, Ref. No. 1049.x03. The bolts, washers and locking nuts are included. Use four bolts per strap. Up to three ladders can be joined without an additional roof hook and fastening bracket being needed.

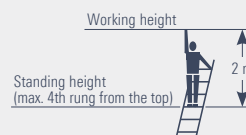
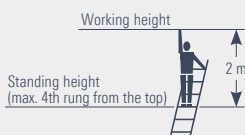



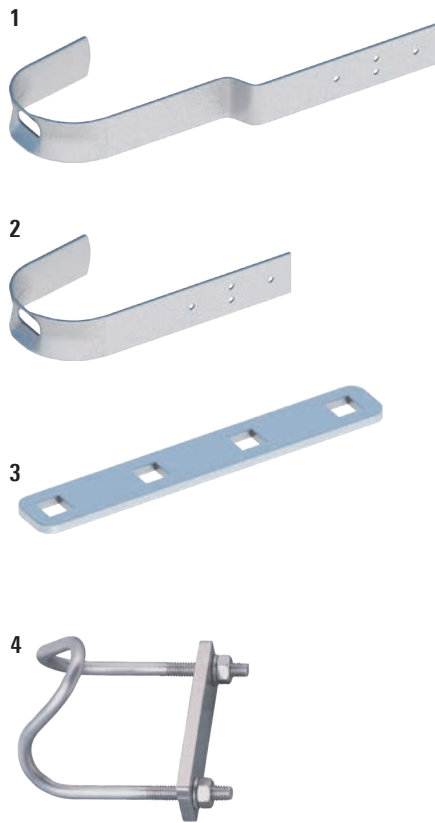

Exemplary application of the safety hook model Z (Pos. 1)

Pos.	Description	Dimensions [m]	Weight approx. [kg]	PU	Ref. No.
1	<b>Safety hook. model Z</b> according to DIN EN 517 For use on tiled roofs, incl. nails	galvanized RAL 8004 RAL 8011 RAL 7016	0.40 x 0.25 x 0.04	0.9	<b>1049.001</b> 📦
				0.9	<b>1049.101</b> 📦
				0.9	<b>1049.201</b> 📦
				0.9	<b>1049.301</b> 📦
2	<b>Safety hook. model B</b> according to DIN EN 517 For use on slate roofs, incl. nails	galvanized RAL 8004 RAL 8011 RAL 7016	0.40 x 0.25 x 0.04	0.8	<b>1049.002</b> 📦
				0.8	<b>1049.102</b> 📦
				0.8	<b>1049.202</b> 📦
				0.8	<b>1049.302</b> 📦
3	<b>Connecting strap</b> Including bolts, washers and nuts of stainless steel	galvanized RAL 8004 RAL 8011 RAL 7016	0.20 x 0.02 x 0.005	0.5	<b>1049.003</b> 📦
				0.5	<b>1049.103</b> 📦
				0.5	<b>1049.203</b> 📦
				0.5	<b>1049.303</b> 📦
4	<b>Fastening bracket</b> according to DIN 18160-5, galvanized			0.1	<b>1049.000</b> 📦

You can find instructions for assembly and use under [downloads.layher.com](https://downloads.layher.com)

The roof ladder 1051 plus the above accessory parts (apart from the fastening bracket) are available in 4 colour variants:

Alu natural  
or galvanized

RAL 8004  
Copper brown

RAL 8011  
Nut brown

RAL 7016  
Anthracite grey

PU = packaging unit 📦 = available ex works 🕒 = delivery time on request 📦 = only available in this packaging unit

## All-purpose boxes

### All-purpose boxes 1016

Sturdy transport container made from 1 mm thick aluminium sheet. Lightweight, strong and shape-retaining thanks to all-round beading and moulded corner reinforcements. Very strong hinged lid with limiting straps to prevent ripping out of the hinges. Its four nylon/polyester stacking corners make it ideal for stacking on EURO pallets. Safety handles with springs, rubber-coated, for convenient transport. Sturdy lever-action clamps, with holes for a padlock and an option for fitting of cylinder locks, safeguard the contents. Allround rubber seal inside the box section protects the contents from dust, dirt and splash water. Resistant to corrosion, weather effects and extreme temperatures (from  $-40\text{ }^{\circ}\text{C}$  to  $+180\text{ }^{\circ}\text{C}$ ). In the boxes **1016.907** and **1016.909**, the bottom and lid are additionally strengthened with aluminium reinforcement strips.



#### Handle assembly



Type 29

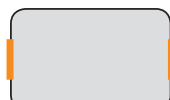

Type 47

Type 76, 91, 140,  
157, 163, 240

Type 415



#### Alu all-purpose boxes 1016

Type	Outer dimension (LxWxH) [mm]	Inner dimension (LxWxH) [mm]	Vol. [ltr]	Weight [kg]	Max. permissible load capacity [kg]	Ref. No.
Type 29	432 x 335 x 277	400 x 300 x 245	29	3.2	40	<b>1016.901</b> 📦
Type 47	582 x 385 x 277	550 x 350 x 245	47	4.5	80	<b>1016.902</b> 📦
Type 76	582 x 385 x 409	550 x 350 x 380	73	5.3	120	<b>1016.903</b> 📦
Type 91	782 x 385 x 379	750 x 350 x 350	92	6.1	130	<b>1016.904</b> 📦
Type 140	902 x 495 x 379	870 x 460 x 350	140	8.0	160	<b>1016.905</b> 📦
Type 157	782 x 585 x 412	750 x 550 x 380	157	8.2	160	<b>1016.906</b> 📦
Type 163	1182 x 385 x 412	1150 x 350 x 380	153	9.5	160	<b>1016.907</b> 📦
Type 240	782 x 585 x 622	750 x 550 x 590	243	10.0	160	<b>1016.908</b> 📦
Type 415	1192 x 790 x 517	1160 x 755 x 485	425	16.0	200	<b>1016.909</b> 📦

Subject to technical modification. All deliveries shall only be made exclusively in accordance with our currently valid General Terms of Sale.

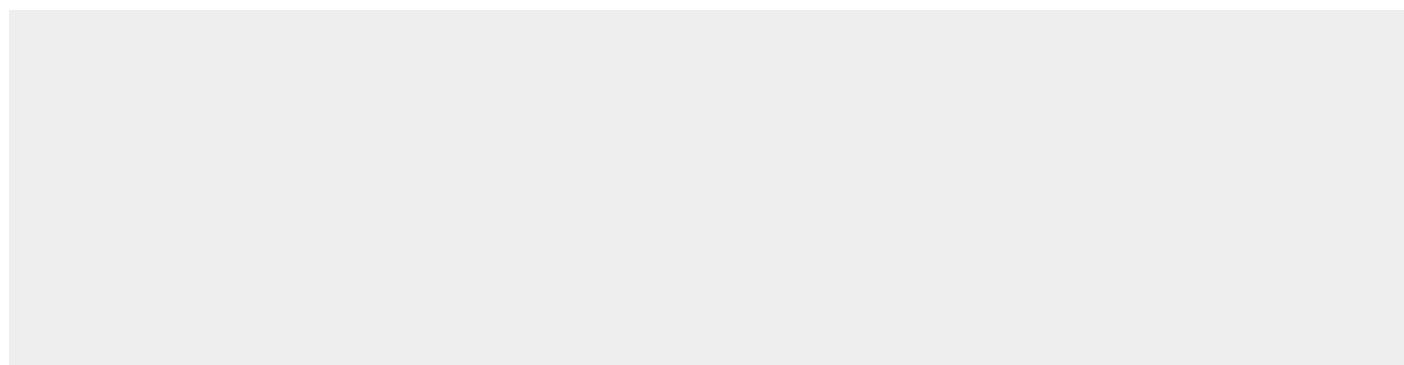

# LAYHER ACCESSES



Stair type	Alu start-stairway 110	Alu stairway 111	Alu stairway with platform 112	Alu maintenance platform 113	Alu bridging stairway 114
<b>Description</b>	For machine access with comfortable footing.	Permanently fitted access for higher heights.	Permanently fitted access for higher heights with large platform e.g. for doors.	Mobile access to higher shelves or maintenance work in higher heights.	Machine crossing with a wide runway.
<b>Step width</b>	0.60 m or 0.80 m	0.60 m or 0.80 m	0.60 m or 0.80 m	0.60 m or 0.80 m	0.60 m or 0.80 m
<b>Step length</b>	200 mm	200 mm	200 mm	200 mm	200 mm
<b>Inclination</b>	45°	45° or 60°	45° or 55°	45° or 55°	45° or 55°
<b>Platform length</b>	0.40 m	0.20 m	0.60 m	0.60 m	0.80 m
<b>Step spacing</b>	200 mm	200 bis 250 mm (dependance of the inclination)	200 bis 225 mm (dependance of the inclination)	200 bis 225 mm (dependance of the inclination)	200 bis 225 mm (dependance of the inclination)
<b>Max. step load</b>	150 kg	150 kg	150 kg	150 kg	150 kg
<b>Max. total load</b>	300 kg	300 kg	300 kg	300 kg	300 kg

## THE BENEFITS TO YOU AT A GLANCE

- ▶ 200 mm wide step sections with a sure-footed groove.
- ▶ Handrails made of 40 mm round tubes with cast aluminum connectors.
- ▶ For transport reasons, the stairs are supplied as pre-assembled groups, an assembly drawing is enclosed with the delivery.
- ▶ Other sizes and designs available on request.

## Accesses

### Alu start-stairway statical or movable 110

For container charging or machine maintenance.

Special stile made of strong aluminium section.  
Step profile grooved for sure footing.

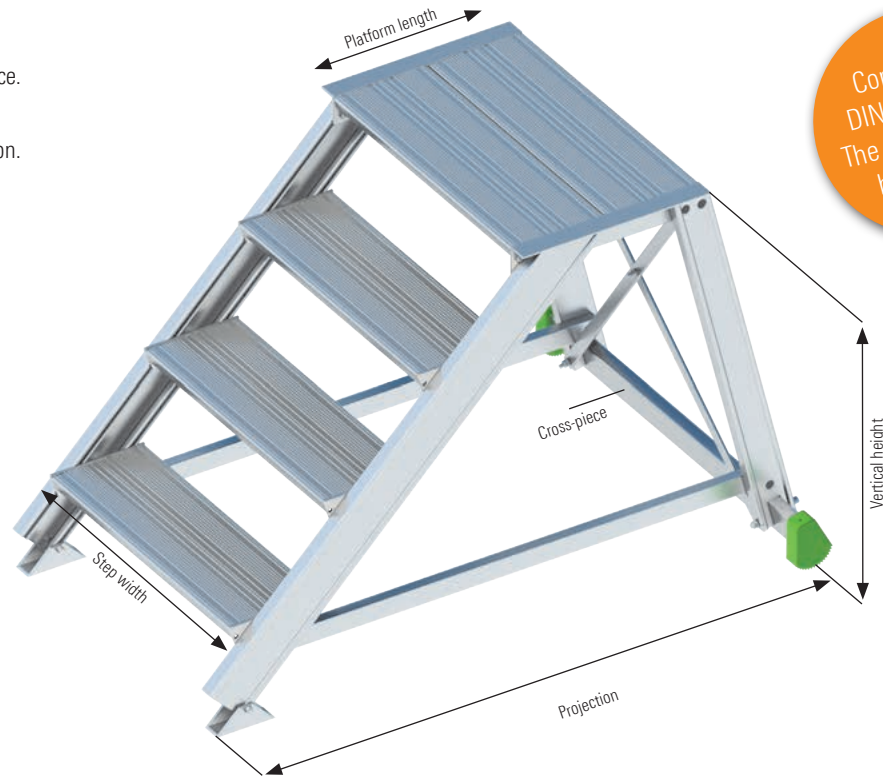
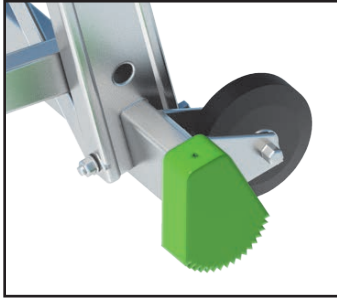

#### Stairway width:

Step width + 0.06 m + cross-piece

#### Vertical height:

Max. 0.99 m (Measures from floor to upper edge of the platform)

#### Cross-piece:

For safer standing (Cross-piece length: step length + 0.20 m)

#### Lift castors (optional):

For moving the start-stairway like a barrow

Inclination	Width [m]	Vertical height [m]	0.40	0.60	0.80	0.99		
45°	0.60	Number of steps	2	3	4	5		
		Projection [m]	0.76	1.00	1.30	1.50		
		Weight [kg]	11.0	14.0	17.5	20.7		
		Ref. No. without lift castors	1106.102	1106.103	1106.104	1106.105		
	0.80	0.60	Ref. No. with lift castors	1106.122	1106.123	1106.124	1106.125	
			Weight [kg]	12.0	15.2	18.9	22.3	
		0.80	Ref. No. without lift castors	1108.102	1108.103	1108.104	1108.105	
			0.80	Ref. No. with lift castors	1108.122	1108.123	1108.124	1108.125

Subject to technical modification. All deliveries shall only be made exclusively in accordance with our currently valid General Terms of Sale. Delivery time upon request. Delivery includes assembly drawing.

## Alu stairway 111

A safe and permanently fitted access. Wherever material, equipment and machinery have to be stored or operated at a height. Rapid working is assured by convenient and effortless movement even with loads.

### Step width:

Step width + 0.10 m with one-side handrail

Step width + 0.13 m with both-side handrail

### Projection:

Measures from front edge to wall

### Vertical height:

Max. 3.90 m (Measures from floor to upper edge of the top step)

### Handrail:

Handrails can be ordered for additional charge. The DIN EN ISO 14122-3 must be followed! Accordingly, for a stairway with a 45° slope a handrail is specified for at least one side. For a 45° angle and a wall clearance exceeding 200 mm, or for 60°, a handrail must be provided on both sides. (Measured from the upper edge of the top step to the upper edge of the guardrail).

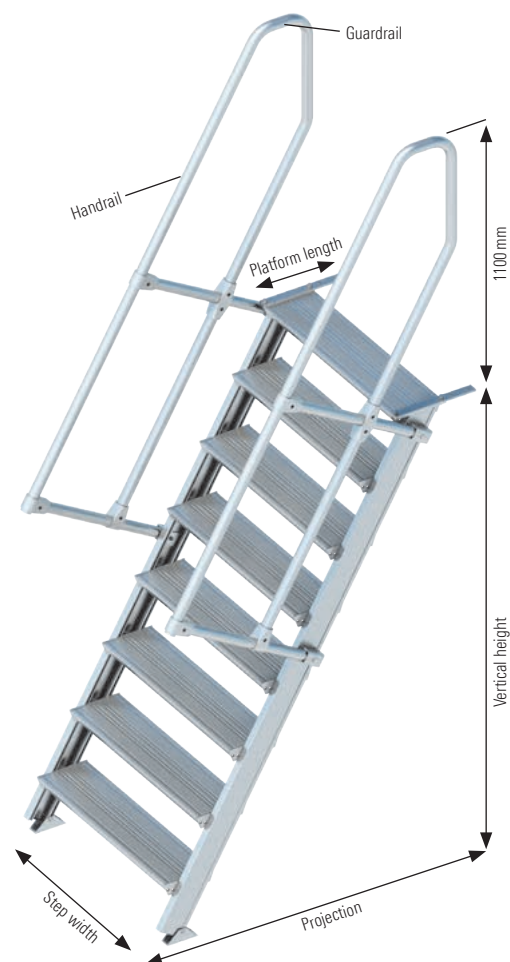

Inclination	Width [m]	Vert. height [m]	0.60	0.80	1.00	1.20	1.40	1.60	1.80	2.00	Other variants on request
45°		Number of steps	3	4	5	6	7	8	9	10	
		Projection [m]	0.75	0.95	1.15	1.35	1.55	1.75	1.95	2.05	
	0.60	Weight [kg]	7.1	10.1	12.5	15.4	17.8	20.8	23.7	29.1	
		Ref. No.	1116.103	1116.104	1116.105	1116.106	1116.107	1116.108	1116.109	1116.110	
	0.80	Weight [kg]	9.1	12.6	15.5	18.9	21.8	25.3	29.7	35.1	
		Ref. No.	1118.103	1118.104	1118.105	1118.106	1118.107	1118.108	1118.109	1118.110	
Handrail		Ref. No.	1110.003	1110.004	1110.005	1110.006	1110.007	1110.008	1110.009	1110.010	
Inclination	Width [m]	Vert. height [m]	0.675	0.90	1.125	1.35	1.575	1.80	2.025	2.25	
60°		Number of steps	3	4	5	6	7	8	9	10	
		Projection [m]	0.53	0.66	0.79	0.92	1.05	1.18	1.31	1.44	
	0.60	Weight [kg]	7.3	10.4	11.9	14.5	17.1	19.7	22.3	24.9	
		Ref. No.	1116.203	1116.204	1116.205	1116.206	1116.207	1116.208	1116.209	1116.210	
	0.80	Weight [kg]	9.3	12.9	14.9	17.5	21.1	24.7	28.3	30.9	
		Ref. No.	1118.203	1118.204	1118.205	1118.206	1118.207	1118.208	1118.209	1118.210	
Handrail		Ref. No.	1110.023	1110.024	1110.025	1110.026	1110.027	1110.028	1110.029	1110.030	

Subject to technical modification. All deliveries shall only be made exclusively in accordance with our currently valid General Terms of Sale. Delivery time upon request. Delivery includes assembly drawing.

## Accesses

### 112

**Statically:** Statically mountable at building for emergency exit, at machines, as heightened workstation a.s.o.

**Step width:**

Step width + 0.10 m with one-side handrail

Step width + 0.13 m with both-side handrail

**Projection:**

Measures from front edge to wall

**Vertical height:**

Max. 4.00 m (Measures from floor to upper edge of the platform)

**Handrail / Guardrail:**

Handrails and guardrails can be ordered for additional charge.

The DIN EN ISO 14122-3 must be followed! Accordingly, for a stairway with a 45° slope a handrail is specified for at least one side. For a 45° angle and a wall clearance exceeding 200 mm, or for 60°, a handrail must be provided on both sides. (Measured from the upper edge of the stage to the upper edge of the guardrail).

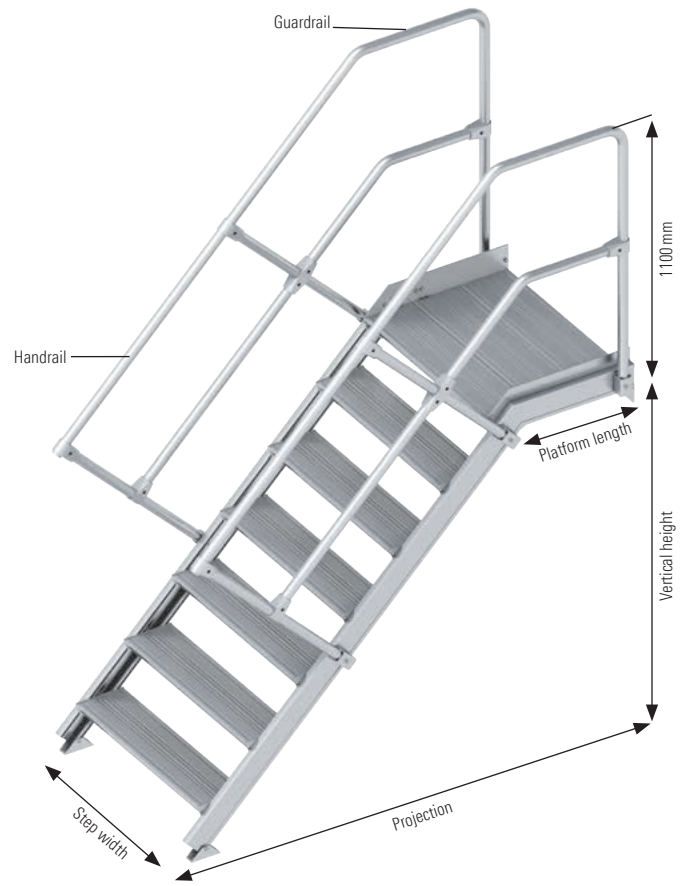

Inclination	Width [m]	Vert. height [m]	0.60	0.80	1.00	1.20	1.40	1.60	1.80	2.00	Other variants on request	
45°	0.60	Number of rungs	3	4	5	6	7	8	9	10		
		Projection [m]	1.15	1.35	1.55	1.75	1.95	2.15	2.35	2.55		
		Weight [kg]	22.8	25.3	28.2	31.1	33.5	36.5	39.4	44.3		
		Ref. No.	1126.103	1126.104	1126.105	1126.106	1126.107	1126.108	1126.109	1126.110		
	0.80	Weight [kg]	26.8	29.3	33.2	36.6	39.5	43.0	46.4	51.8		
		Ref. No.	1128.103	1128.104	1128.105	1128.106	1128.107	1128.108	1128.109	1128.110		
		Handrail/Guardrail	Ref. No.	1120.003	1120.004	1120.005	1120.006	1120.007	1120.008	1120.009		1120.010
		Ref. No.										
55°	0.60	Number of rungs	3	4	5	6	7	8	9	10		
		Projection [m]	0.93	1.06	1.19	1.32	1.45	1.58	1.71	1.84		
		Weight [kg]	21.5	24.1	27.1	29.9	32.7	35.6	38.4	41.3		
		Ref. No.	1126.203	1126.204	1126.205	1126.206	1126.207	1126.208	1126.209	1126.210		
	0.80	Weight [kg]	25.5	28.1	31.6	35.2	38.8	43.4	47.0	50.6		
		Ref. No.	1128.203	1128.204	1128.205	1128.206	1128.207	1128.208	1128.209	1128.210		
		Handrail/Guardrail	Ref. No.	1120.023	1120.024	1120.025	1120.026	1120.027	1120.028	1120.029	1120.030	
		Ref. No.										

Subject to technical modification. All deliveries shall only be made exclusively in accordance with our currently valid General Terms of Sale. Delivery time upon request. Delivery includes assembly drawing.

## Alu maintenance platform 113

Versatile maintenance device for machines, containers, trucks, buses, shelves a.s.o. which do not allow the mounting of a statical solution.

### Step width:

Step width + 0.10 m with one-side handrail + cross-piece  
Step width + 0.13 m with both-side handrail + cross-piece

### Vertical height:

Max. 4.00 m (Measures from floor to upper edge of the platform)

### Handrail / Guardrail:

Standard delivery is including all-round guardrails and both-side handrails. On demand, the stairway can be ordered with one-side handrail / guardrail or without any. The DIN EN ISO 14122-3 must be followed! (Measured from the upper edge of the stage to the upper edge of the guardrail).

### Cross-piece:

For safer standing

### Castors:

Wheel with lock, which blocks the wheel and forkhead

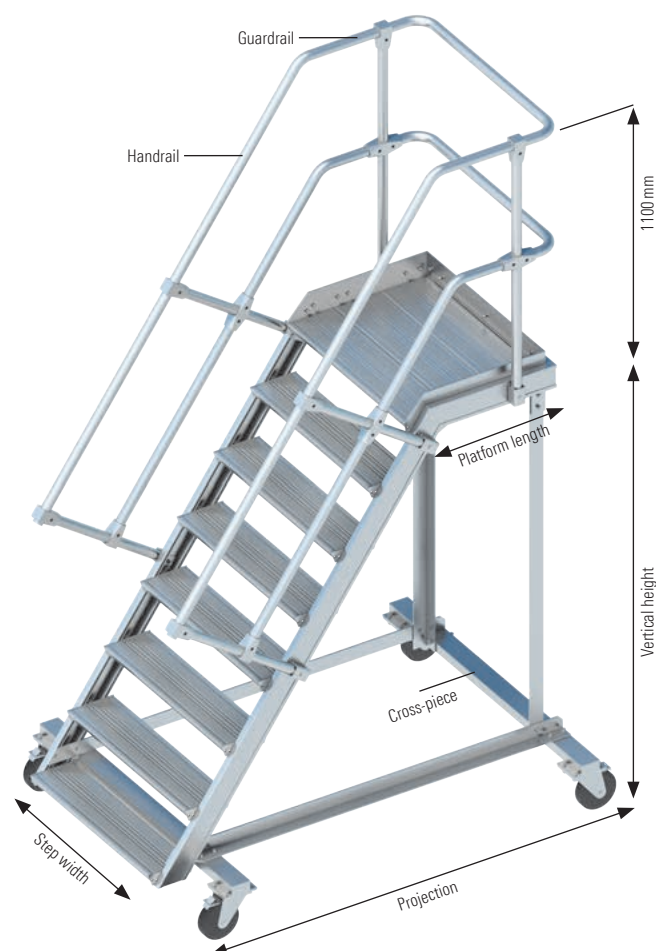

Inclination	Width [m]	Vert. height [m]	0.60	0.80	1.00	1.20	1.40	1.60	1.80	2.00	Other variants on request
45°	0.60	Number of rungs	3	4	5	6	7	8	9	10	
		Projection [m]	1.62	1.78	2.04	2.30	2.40	2.72	2.90	3.12	
		Cross-piece [m]	0.94	0.94	1.00	1.00	1.10	1.10	1.10	1.15	
		Weight [kg]	50.4	54.6	59.9	64.1	70.4	74.2	80.5	88.2	
		Ref. No.	1136.103	1136.104	1136.105	1136.106	1136.107	1136.108	1136.109	1136.110	
45°	0.80	Cross-piece [m]	1.15	1.15	1.25	1.25	1.30	1.30	1.30	1.40	
		Weight [kg]	55.7	59.9	66.2	71.9	76.6	84.0	89.9	97.7	
		Ref. No.	1138.103	1138.104	1138.105	1138.106	1138.107	1138.108	1138.109	1138.110	
Inclination	Width [m]	Vert. height [m]	0.675	0.90	1.125	1.35	1.575	1.80	2.025	2.25	
55°	0.60	Number of rungs	3	4	5	6	7	8	9	10	
		Projection [m]	1.47	1.63	1.78	1.95	2.10	2.26	2.41	2.58	
		Cross-piece [m]	0.94	0.94	1.00	1.00	1.10	1.10	1.10	1.15	
		Weight [kg]	48.0	52.0	57.0	61.0	67.0	71.0	77.0	84.0	
		Ref. No.	1136.203	1136.204	1136.205	1136.206	1136.207	1136.208	1136.209	1136.210	
55°	0.80	Cross-piece [m]	1.15	1.15	1.25	1.25	1.30	1.30	1.30	1.40	
		Weight [kg]	53.0	57.0	63.0	68.5	73.0	80.0	85.5	93.0	
		Ref. No.	1138.203	1138.204	1138.205	1138.206	1138.207	1138.208	1138.209	1138.210	

Subject to technical modification. All deliveries shall only be made exclusively in accordance with our currently valid General Terms of Sale. Delivery time upon request. Delivery includes assembly drawing.

## Accesses

### Alu bridging stairway, statical or movable 114

**Statical** For bridgings at containers, machines, band-conveyors a.s.o.  
Attachment using angular mounting sections at bottom of stairway.

**Movable:** As operating platform, maintenance device a.s.o. Cross-piece and castors with brake, which locks wheel and clevis – upon request.

**Step width:**

Step width + 0.10 m with one-side handrail

+ cross-piece (movable)

Step width + 0.13 m with both-side handrail

+ cross-piece (movable)

**Clear width:**

0.55 m

**Vertical clear height:**

Max. 4.00 m

(Measures from floor to bottom edge of the platform)

**Handrail/Guardrail:**

Handrails and guardrails can be ordered for additional charge. The DIN EN ISO 14122-3 must be followed!

Accordingly, for a stairway with a 45° slope a handrail is specified for at least one side. For a 45° angle and a wall clearance exceeding 200 mm, or for 60°, a handrail must be provided on both sides.

(Measured from the upper edge of the stage to the upper edge of the guardrail).

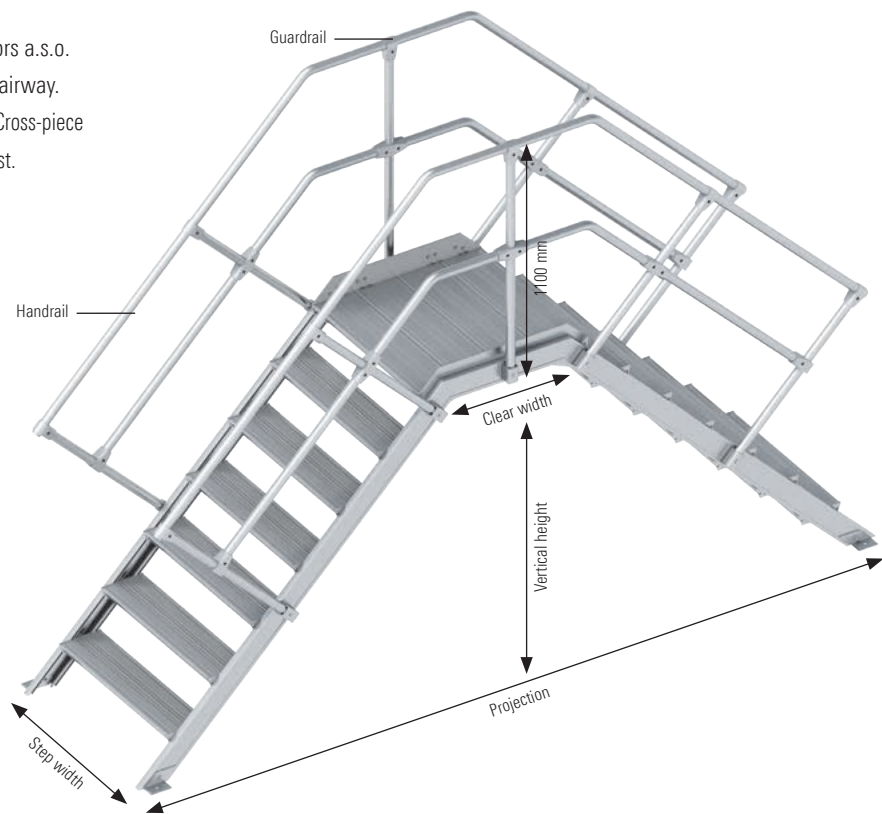

Inclination	Width [m]	Vert. clear height [m]	0.60	0.80	1.00	1.20	1.40	1.60	1.80	2.00	Other variants on request
45°	0.60	Number of rungs	3	4	5	6	7	8	9	10	
		Projection [m]	1.94	2.36	2.78	3.20	3.40	4.12	4.56	5.00	
		Weight [kg]	32.0	35.3	39.2	43.4	55.0	62.5	70.5	79.4	
		Ref. No.	1146.103	1146.104	1146.105	1146.106	1146.107	1146.108	1146.109	1146.110	
		Weight [kg]	37.8	42.5	47.6	52.6	65.7	74.4	82.9	93.6	
		Ref. No.	1148.103	1148.104	1148.105	1148.106	1148.107	1148.108	1148.109	1148.110	
<b>Handrail/Guardrail</b>		Ref. No.	1140.003	1140.004	1140.005	1140.006	1140.007	1140.008	1140.009	1140.010	
Inclination	Width [m]	Vert. clear height [m]	0.62	0.85	1.07	1.30	1.53	1.75	1.98	2.20	
55°	0.60	Number of rungs	3	4	5	6	7	8	9	10	
		Projection [m]	1.67	2.00	2.30	2.62	2.94	3.25	3.57	3.88	
		Weight [kg]	30.9	34.1	37.8	42.0	53.2	60.4	67.6	76.8	
		Ref. No.	1146.203	1146.204	1146.205	1146.206	1146.207	1146.208	1146.209	1146.210	
		Weight [kg]	36.4	40.7	45.8	51.1	63.4	71.7	80.0	90.3	
		Ref. No.	1148.203	1148.204	1148.205	1148.206	1148.207	1148.208	1148.209	1148.210	
<b>Handrail/Guardrail</b>		Ref. No.	1140.023	1140.024	1140.025	1140.026	1140.027	1140.028	1140.029	1140.030	

Subject to technical modification. All deliveries shall only be made exclusively in accordance with our currently valid General Terms of Sale. Delivery time upon request. Delivery includes assembly drawing.





## Rolling towers

# LAYHER ROLLING TOWERS

THE QUALITY IS IN THE DETAILS



Layher rolling towers offer professionals in the building trade and in industry individualised solutions for every task, but without extensive material being needed. Thanks to the modular principle, many assembly variants are possible with a few components. That reduces the need for stocks and cuts logistic costs. The lightweight and handy system components made of aluminium with snap-on claw not only permit quick and easy assembly, but also ensure high stability for concentrated working at a height of nearly 14 meters. Layher rolling towers are a persuasive solution thanks to their ample working platform and working height adjustment. Their adaptability to site conditions enables every professional on the scaffolding to work ergonomically and so improve their individual safety and efficiency.

For top performance at great heights, you need high stability. Layher has, with its consistent approach to safety and quality, designed products which conform to statutory safety requirements. Inspections by independent institutes have corroborated this. The Layher brand stands for more than 70 years of experience in the design and manufacture of rolling towers at the central production location in Güglingen. Quality "Made by Layher" means "Made in Germany".

With its rolling tower family, Layher offers customers from the building trades and from industry scaffolding systems for economical working at any height, both indoors and outdoors.

### YOUR BENEFITS AT A GLANCE

- ▶ Layher offers for every site requirement the rolling tower to match. Thanks to the modular principle, many assembly variants are possible with a few components.
- ▶ The option of using the Layher Safety Assembly P2 enable you to conform to the German Ordinance on Industrial Safety and Health without extra expense.
- ▶ Ergonomic assembly and high profitability thanks to the handy system components made of aluminium.
- ▶ You can rely on maximum quality and safety thanks to a recognised quality management system and inspections by independent institutes.





### WHEELS

Sturdy wheels for high manoeuvrability and stable stance during work. Various wheel coatings permit use even on sensitive floor coverings. The steel base plates ensure easy and precise height equalisation while transmitting the loads centrally into the locked wheel. This improves the stability, enabling the user to work efficiently.



### LADDER FRAMES

The ladder frame doubles as the scaffolding frame and as an access. The grooves of the rungs ensure maximum slip prevention and secure grip for vertical access.

The ladder frames are available in the lengths 1.00 m and 2.00 m and in the widths 0.75 m and 1.50 m. Long and conical spigots ensure a secure and easy-action connection of the ladder frames to one another, easily made safe by spring clips.



### GUARDRAILS AND DIAGONAL BRACES WITH SNAP-ON CLAWS

Unbeatably fast connection without using tools. A slight pressure, and the claw snaps into place by itself.

Various colours of the claw fingers for guardrails and diagonal braces help to tell the components apart – that saves time.

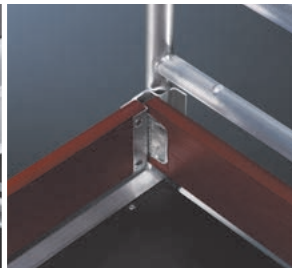

### DECKS

Sturdy decks made from aluminium frames with plywood insert and snap-on claws ensure easy handling. They have a non-slip surface for a firmer and safer stance even in wet weather. A maximum-size working surface is obtained with a width of 68 cm. The differently shaped snap-on claws permit easy 1-man assembly and at the same time provide quadruple lift-off prevention. The toe board for protection from falling material or tools form a self-holding rim to ensure a maximum working surface.



### STABILITY

The stability of the rolling tower must be assured for every phase of its assembly and dismantling. Depending on the assembly height and whether the tower is assembled outdoors or in a closed room, the following measures must be taken:

- ▶ installation of mobile beam
- ▶ use of stabilisers
- ▶ ballasting



## Rolling towers

## LAYHER ROLLING TOWERS

THE RIGHT ROLLING TOWER FOR EACH TASK



Tower model	Zifa	Uni Light	Uni Compact
<b>Description/ Features</b>	Fits through room doors when assembled and loaded, requires little space for transport	Ideal for cramped conditions at the place of use	Double-width working surface, yet with compact outer dimensions.
<b>Dimensions of working platform</b>	0.75 x 1.80 m	0.75 x 1.80 m	1.50 x 1.80 m
<b>Max. working height (in closed areas)</b>	7.76 m	9.26 m	10.38 m
<b>Max. working height (outdoors)</b>	7.76 m	9.26 m	9.38 m
<b>Permissible live load</b>	2.0 kN/m <sup>2</sup>	2.0 kN/m <sup>2</sup>	2.0 kN/m <sup>2</sup>
<b>Maximum permissible UDL*</b>	240 kg	240 kg	485 kg

## LAYPLAN ROLLING TOWER-CONFIGURATOR



By using this LayPLAN module, it is possible to choose between standard and individual rolling tower solutions – quickly and easily. After entering of working height, the required working space and selection of the equal assembly structure, the program gives you a solution offer with pictures and material lists. Applications with internal ladder access, wall support or console brackets can be chosen – also as structures with mobile beam or stabilizers. All assembly structures according to the user manuals are available.

## YOUR BENEFITS AT A GLANCE

- ▶ Quick planning and selection of the equal rolling tower type. No matter if standard or individual.
- ▶ Download of all user manuals of the Layher rolling towers.
- ▶ Optionally the material list can be generated with or without required ballastings.
- ▶ Single components can be edited, added or deleted from the material list.

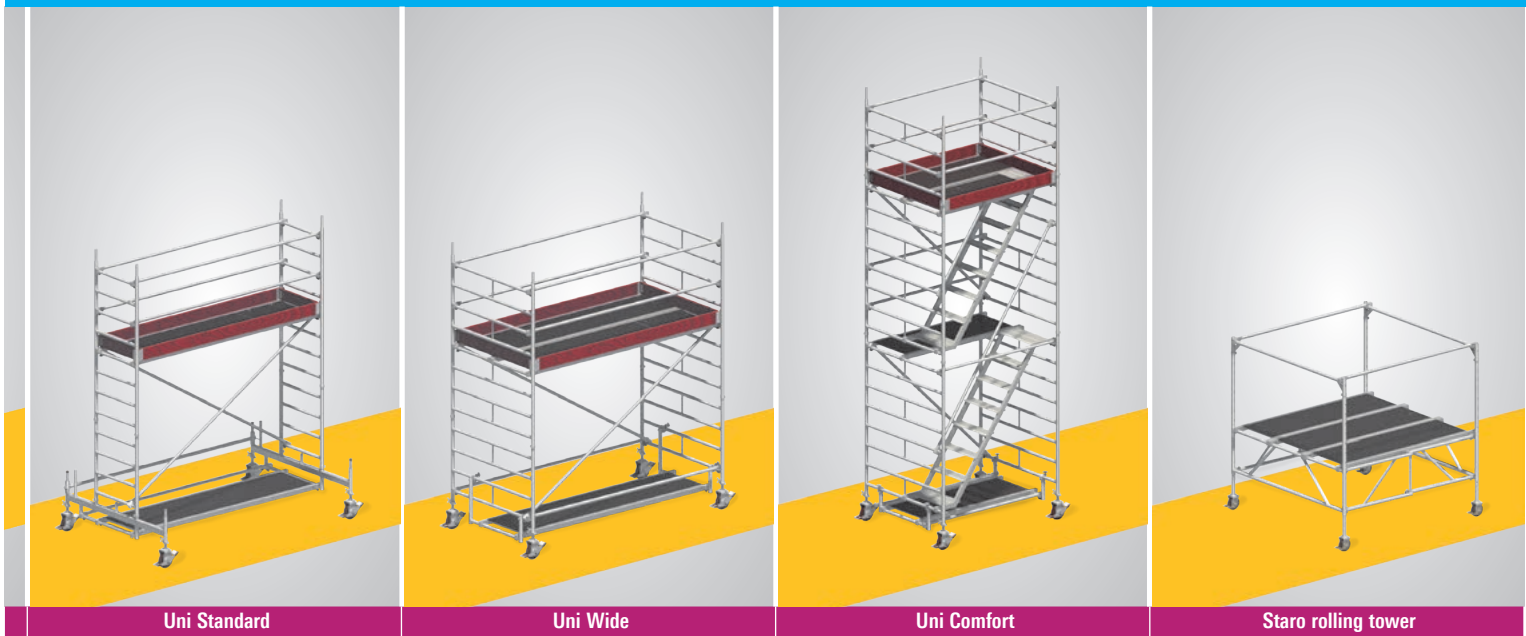

Uni Standard	Uni Wide	Uni Comfort	Staro rolling tower
Designed for maximum heights, lightweight, sturdy, durable – the flexible basic model	Double-width working surface, needs base widening only when height exceeds 8.38 m	Convenient stairway access	Excellent freedom of movement and plenty of room for material, height adjustable every 11 cm
0.75 x 2.85 m	1.50 x 2.85 m	1.50 x 1.80 m	1.95 x 1.95 m
13.38 m	13.38 m	14.20 m	3.90 m
9.38 m	9.38 m	10.20 m	3.90 m
2.0 kN / m <sup>2</sup>	2.0 kN / m <sup>2</sup>	2.0 kN / m <sup>2</sup>	1.5 kN / m <sup>2</sup>
380 kg	765 kg	485 kg	570 kg

When you buy, you receive instructions for assembly and use that must be followed without fail for assembly, dismantling and use.  
 \* According to the max. working surface

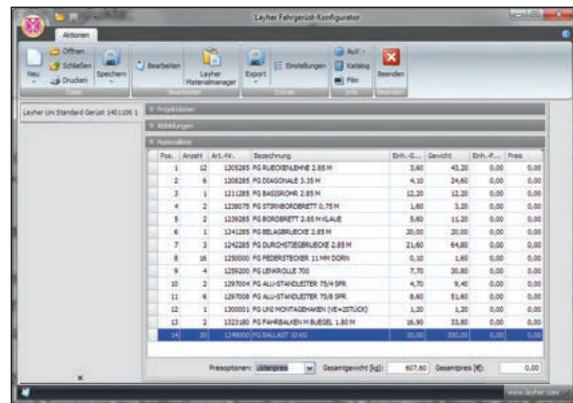
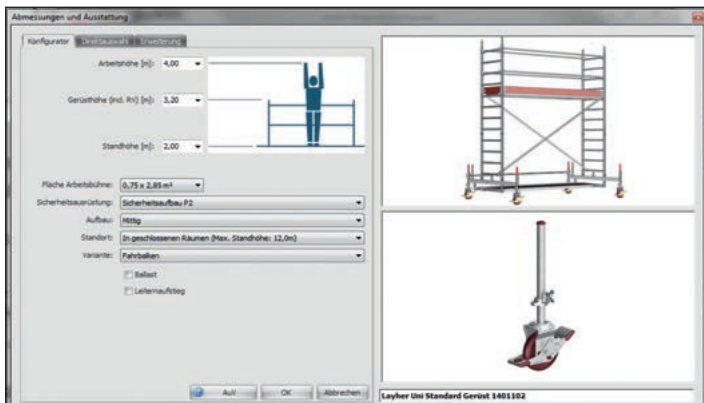

LayPLAN Rolling Tower Configurator  
**Order now for free.**

## More safety, when using Layher rolling towers

To comply with European industrial safety laws, you as an employer must ensure that your workforce is only provided with equipment that, when used for its intended purpose, guarantees both safety and health protection. Appropriate safety measures have to be taken by you. Collective risk prevention takes precedence here over individual risk prevention.

To comply in full with all requirements, Layher has now devised the new Safety Structure P2. The Layher Safety Structure P2 represents the collective safety measure.

### The New Safety Structure P2

- ▶ Platforms with a vertical spacing of 2 m.
- ▶ Safe design with integrated collective side protection.

Thanks to the platforms assembled with a 2 meter spacing, the rear guardrails can already be fitted from the level below, so that when the next platform up is accessed there is already a simple side protection in place in all sides.

#### CAN BE RETROFITTED WITH THE LAYHER MODULAR SYSTEM:

If you already have a Layher rolling tower, you can upgrade it to the P2 design without any problem.

#### YOUR BENEFITS AT A GLANCE

##### The ingeniously simple assembly principle

- ▶ All round side protection already in place when accessing the next platform up.
- ▶ More stability in the rolling tower thanks to additional stiffeners.

##### Platforms spaced 2 meters apart:

- ▶ Maximum safety during assembly, ascent and descent and during the actual work.
- ▶ Easy passing on of rolling tower parts or work materials from one level to the next.

##### The innovative Uni assembly hook:

- ▶ Considerably simplifies assembly and ensures fast and hitch-free assembly and dismantling.

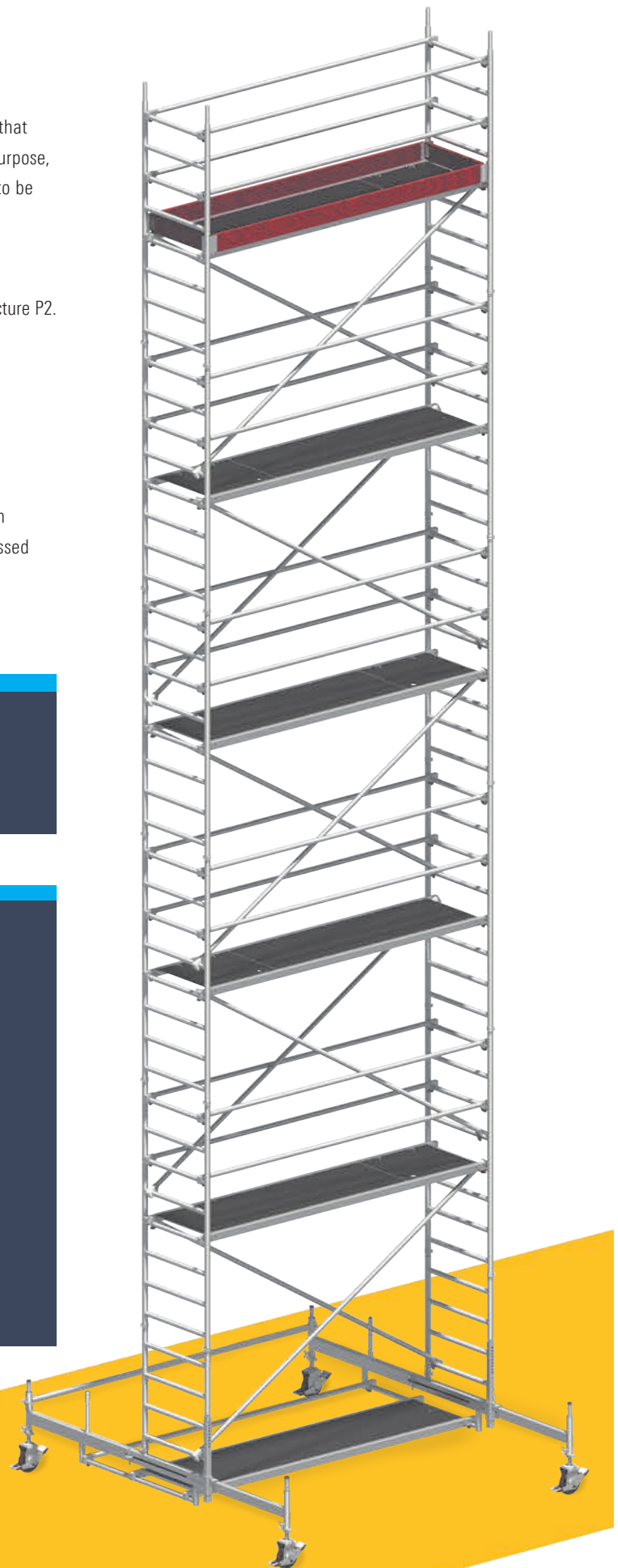

## The principle – Simple. Swift. Safe.

### 1 Fit the first ladder frame.

Attach the Uni assembly hooks and position the second ladder frame for fitting of the rear guardrails.

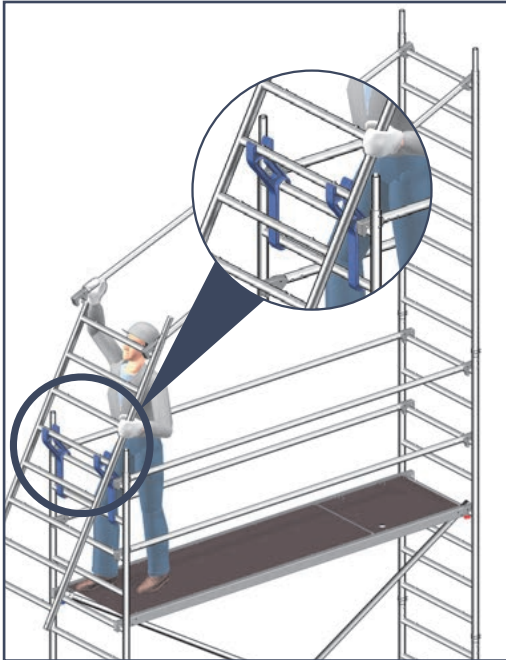

### 2 Swing ladder frame with rear guardrail upwards and fit into place.

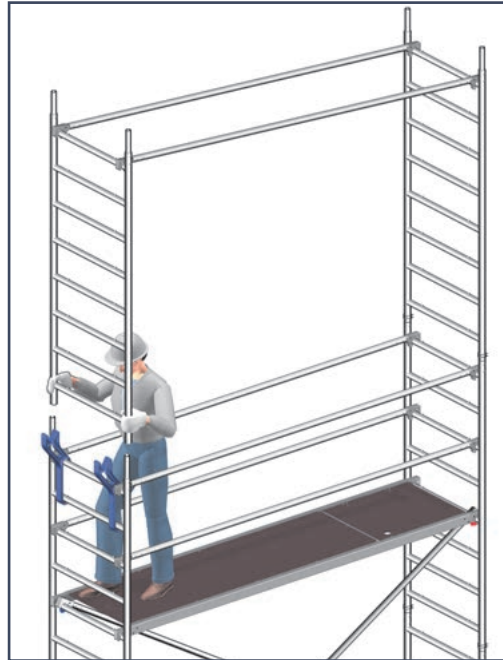

### 3 Insert diagonal braces and access deck.

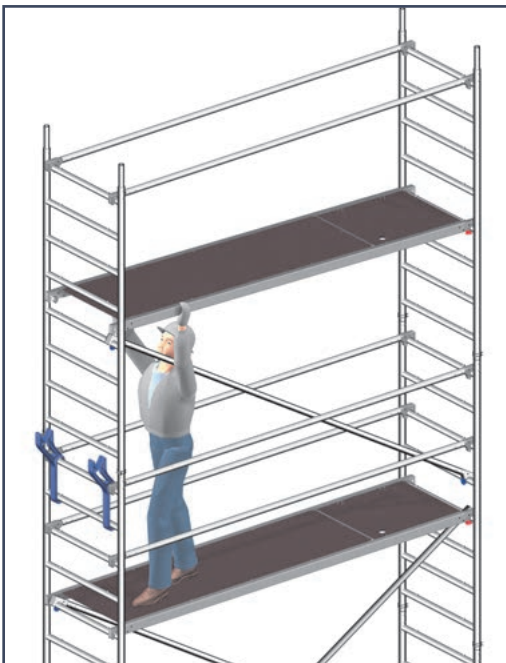

### 4 Ascend to next level and install additional rear guardrails at 0.50 m.

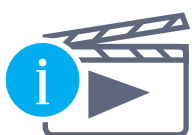

### LEARN MORE

about the safety structure P2  
on YouTube unter:  
[yt-p2-en.layher.com](https://yt-p2-en.layher.com)

## Zifa

## ZIFA

THE "READY-MADE TOWER" FOR WORKING AT LOW HEIGHTS



The Zifa tower is practically a "ready-made tower" for working at low heights: **Folded together flat for storage and transport – fold it out, insert the deck – that's all.**

The basic unit can be passed through standard room doors when assembled and fully loaded.

Basic tower of aluminium for alternating-sequence push-fit assembly; rear guardrails and diagonal braces of aluminium snap in easily.

Work decks with aluminium frame and plywood insert, also as a hatch-type deck for risk-free internal access.

Strong castors (permanently fitted) ensure particular stability.

The zifa family can also be equipped with stabilizers. Learn more about that on page 44.

## TECHNICAL DATA

- ▶ Max. working height: 7.76 m
- ▶ Area of working platform: 0.75 x 1.80 m
- ▶ Permissible live load: 2 kN / m<sup>2</sup> (scaffolding group 3)







## Zifa



### Part list

The Layher modular system permits problem-free expansion of your rolling tower (for pictures see page 82 onwards).

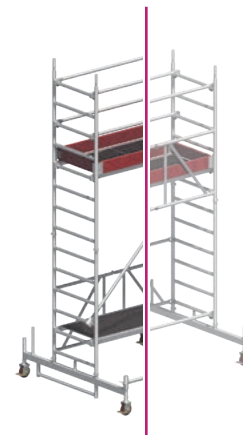
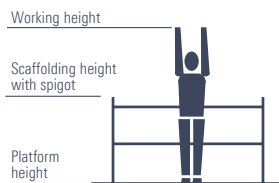
Tower model	Ref. No.	1406200	1406210	1406213 (623)	1406214 (624)	1406215	1406216 (625)
Guardrail 1.80 m	1205.180	0	2	4 (4)	9 (4)	8	13 (8)
Diagonal brace 2.50 m	1208.180	0	0	1 (0)	2 (2)	4	4 (3)
Diagonal brace 1.95 m	1208.195	0	0	0 (0)	1 (0)	0	1 (0)
Horizontal diagonal brace 1.95 m	1209.180	0	0	0 (0)	0 (0)	0	0 (1)
Basic tube 1.80 m	1211.180	0	0	1 (0)	1 (0)	1	1 (1)
Mobile beam 1.80 m without bar	1214.180	0	0	0 (2)	0 (2)	0	0 (2)
End toe board 0.75 m	1238.075	0	0	2 (2)	2 (2)	2	2 (2)
Toe board 1.80 m with claw	1239.180	0	0	2 (2)	2 (2)	2	2 (2)
Deck 1.80 m	1241.180	1	0	1 (0)	0 (0)	1	0 (0)
Access deck 1.80 m	1242.180	0	1	1 (1)	2 (1)	2	3 (2)
Spring clip	1250.000	0	4	8 (8)	12 (12)	12	16 (16)
Ladder frame 75/4 – 1.00 m	1297.004	0	2	0 (0)	2 (0)	0	2 (0)
Ladder frame 75/8 – 2.00 m	1297.008	0	0	2 (0)	2 (0)	4	4 (0)
Uni assembly hook	1300.001	0	0	1 (0)	1 (0)	1	1 (0)
Zifa 75 basic tower	1300.006	1	1	1 (2)	1 (3)	1	1 (4)
Castor 400 – 4 kN	1308.150	4	4	4 (4)	4 (4)	4	4 (4)
Mobile beam with bar	1323.180	0	0	2 (0)	2 (0)	2	2 (0)
Ballast	1249.000	For requirement see table below					



### The Zifa family

Tower model	 	1406200	1406210	1406213 Safety structure P2	623 Min. requirements DIN EN 1004
Working height [m]		2.86	3.61	4.76	4.26
Tower height [m]		1.83	2.83	3.98	3.48
Platform height [m]		0.86	1.61	2.76	2.26
Weight [kg] (without ballast)		42.0	58.0	140.5	113.0
<b>Ballast</b> (stated in units)					
<b>In closed areas</b>					
Assembly central*		14 r4*	16 r6	0 0	0
Assembly off-set		X	X	10 r2	0
Assembly off-set with wall bracing		14 r0*	16 r0	0 0	0
<b>Outdoors</b>					
Assembly central		14 r4*	16 r6	0 0	0
Assembly off-set		X	X	10 r2	0
Assembly off-set with wall bracing		14 r0*	16 r0	0 0	0

\* The here shown ballasting is only necessary when climbing outdoors. X = not possible / not permissible 0 = no ballast required

For ballasting, use Layher ballast weights, Ref. No. 1249.000, 10 kg each. These weights are attached quickly and securely at the right places using the star handle coupler.

All height dimensions are calculated without any spindle travel. The maximum spindle travel of each assembly variant is listed in its assembly instruction guide!

**Do not use any liquid or granular ballast materials. The ballast weight must be distributed evenly to all ballasting fixing points (see instructions for assembly and use).**

In central assembly, the ballast weights are distributed evenly over all four ladder frame standards. The remainder not divisible by 4 must be fitted in accordance with the instructions for assembly and use.

In off-set assembly on mobile beams, the ballast weights must be distributed evenly over the two ladder frame standards away from the wall.

For compliance with the OH & S Layher recommends the safety structure P2.

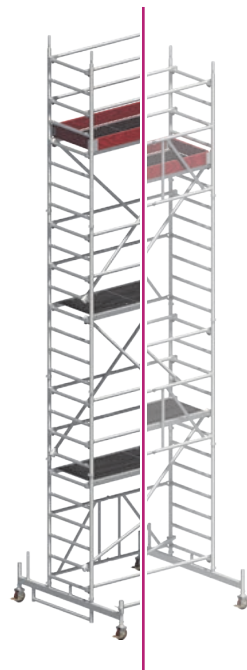

1406214 Safety structure P2	624 Min. requirements DIN EN 1004	1406215 Safety structure P2	1406216 Safety structure P2	625 Min. requirements DIN EN 1004
5.76	5.76	6.76	7.76	7.26
4.98	4.98	5.98	6.98	6.48
3.76	3.76	4.76	5.76	5.26
169.6	140.2	192.2	218.0	199.5
12 r2	12 r2	14 r4	14 r4	14 r4
10 r4	12 R4	10 r6	10 r8	10 R8
12 r0	14 R0	r6 10	18 r0	18 R0
12 r2	12 r2	14 r4	14 r4	14 r4
10 r6	10 R4	10 r8	X	10 R10
14 r0	14 R0	18 r0	116 r0	18 R0

All dimensions and weights are guideline values. Subject to technical modification. Our deliveries shall be made exclusively in accordance with our currently valid General Terms of Sale. Title to the delivered goods shall be retained until full payment has been made. When purchasing, you receive instructions for assembly and use that must be followed without fail or assembly, dismantling and use.

## Zifa with stabilizers, extendable



### Part list

The Layher modular system permits problem-free expansion of your rolling tower (for pictures see page 82 onwards).

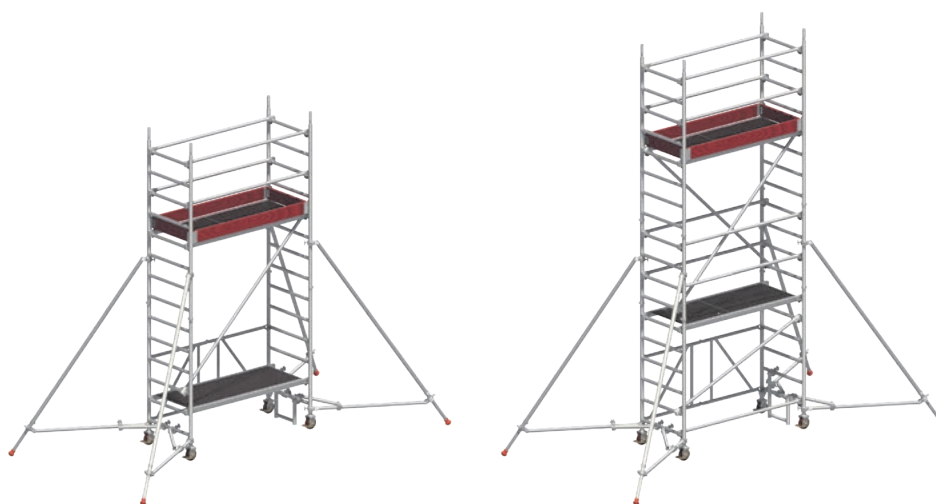
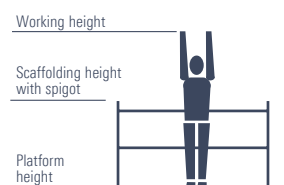
Tower model	Ref. No.	1406233	1406234	1406235	1406236	1406237
Guardrail 1.80 m	1205.180	4	9	8	13	12
Diagonal brace 2.50 m	1208.180	1	2	4	4	6
Diagonal brace 1.95 m	1208.195	0	1	0	1	0
End toe board 0.75 m	1238.075	2	2	2	2	2
Toe board 1.80 m with claw	1239.180	2	2	2	2	2
Deck 1.80 m	1241.180	1	0	1	0	1
Access deck 1.80 m	1242.180	1	2	2	3	3
Alu stabilizer, extendable	1248.260	4	4	4	4	4
Rotation preventer	1248.261	4	4	4	4	4
Ladder frame 75/4 – 1.00 m	1250.000	4	8	8	12	12
Ladder frame 75/8 – 2.00 m	1297.004	0	2	0	2	0
Uni assembly hook	1297.008	2	2	4	4	6
Zifa 75 basic tower	1300.001	1	1	1	1	1
Castor 400 – 4 kN	1300.006	1	1	1	1	1
Mobile beam with bar	1308.150	4	4	4	4	4
Access ledger 0.30 m	1344.002	1	1	1	1	1
Ballast	1249.000	For requirement see table below				



### The Zifa family

Tower model	 	1406233 Safety structure P2	1406234 Safety structure P2
Working height [m]		4.61	5.61
Tower height [m]		3.83	4.83
Platform height [m]		2.61	3.61
Weight [kg] (without ballast)		145.5	174.6
<b>Ballast</b> (stated in units)			
<b>In closed areas</b>			
Assembly central		0	0
Assembly off-set		LO R4	LO R6
Assembly off-set with wall bracing		0	0
<b>Outdoors</b>			
Assembly central		0	0
Assembly off-set		LO R6	LO R10
Assembly off-set with wall bracing		0	0

X = not possible / not permissible 0 = no ballast required

For ballasting, use Layher ballast weights, Ref. No. 1249.000, 10 kg each. These weights are attached quickly and securely at the right places using the star handle coupler.

All height dimensions are calculated without any spindle travel. The maximum spindle travel of each assembly variant is listed in its assembly instruction guide!

**Do not use any liquid or granular ballast materials. The ballast weight must be distributed evenly to all ballasting fixing points (see instructions for assembly and use).**

In central assembly, the ballast weights are distributed evenly over all four ladder frame standards. The remainder not divisible by 4 must be fitted in accordance with the instructions for assembly and use.

In off-set assembly on mobile beams, the ballast weights must be distributed evenly over the two ladder frame standards away from the wall.

## Zifa with stabilizers, extendable

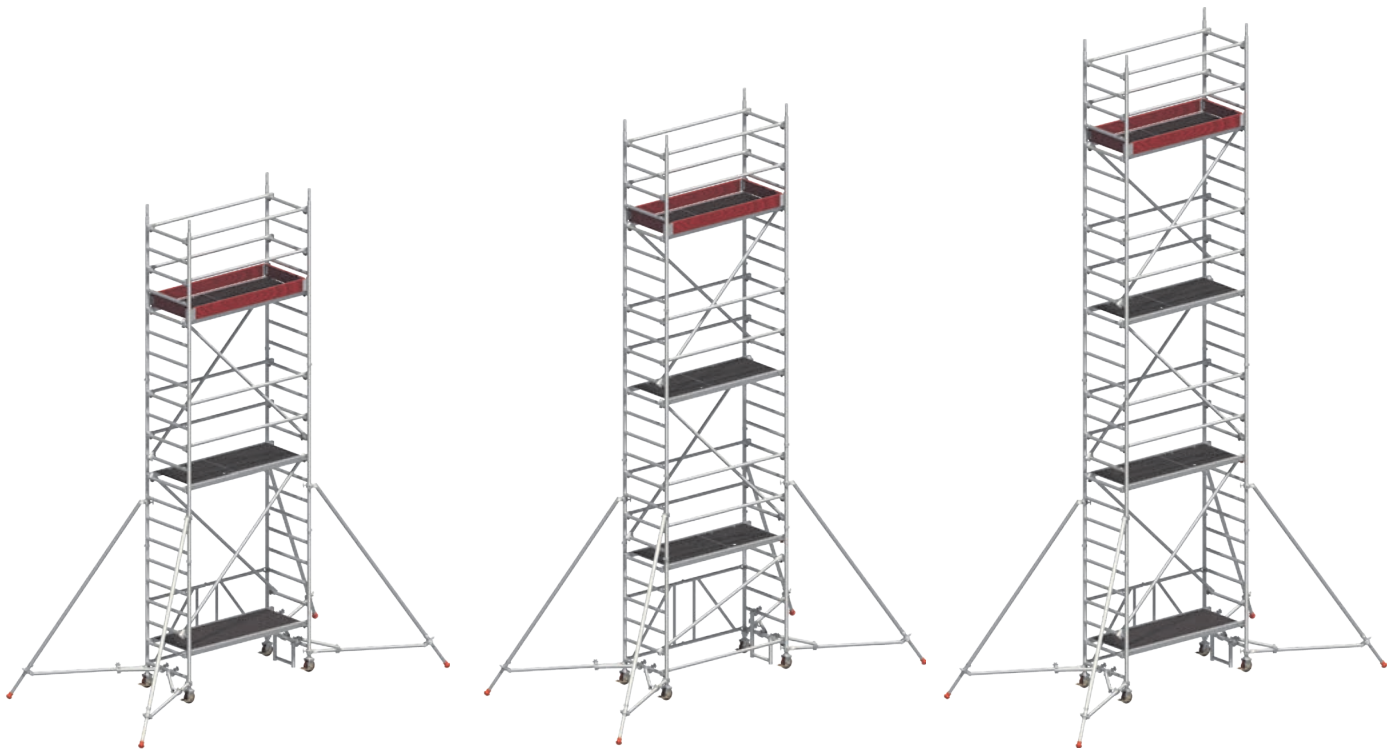

1406235 Safety structure P2	1406236 Safety structure P2	1406237 Safety structure P2
6.61	7.61	8.61
5.83	6.83	7.83
4.61	5.61	6.61
197.2	223.0	245.6
0	12 r2	12 r2
LO R8	LO R10	LO R14
0	0	0
12 r2	14 r4	18 r8
LO R12	LO R18	LO R22
0	0	0

All dimensions and weights are guideline values. Subject to technical modification. Our deliveries shall be made exclusively in accordance with our currently valid General Terms of Sale. Title to the delivered goods shall be retained until full payment has been made. When purchasing, you receive instructions for assembly and use that must be followed without fail or assembly, dismantling and use.

## Uni Light

# UNI LIGHT

THE PRACTICAL ROLLING TOWER FOR WORKING IN CRAMPED CONDITIONS



**The Uni Light tower is a compact and lightweight rolling tower for safe and comfortable working wherever you formerly needed a ladder – the standing surface of a full 1.30 m<sup>2</sup> permits unimpeded movement and the carrying of tools and material.**

Its low weight and handy dimensions make the Uni Light particularly easy to transport, even in a van. Ladder frames of aluminium for push-fit assembly; rear guardrails and diagonal braces of aluminium snap in easily.

Work decks with aluminium frame and plywood insert, as a hatch-type deck for risk-free internal access.

Strong castors (permanently fitted) ensure particular stability.

Mobile rigid beam, made of steel, for widening the base; with spigots for optional mounting of the ladder frames for work on ceilings or walls.

The Uni Light family can also be equipped with stabilizers. Learn more about that on page 50.

### TECHNICAL DATA

- ▶ Max. working height: 9.26 m
- ▶ Area of working platform: 0,75 x 1.80 m
- ▶ Permissible live load: 2 kN / m<sup>2</sup> (scaffolding group 3)



# Uni Light



## Part list

The Layher modular system permits problem-free expansion of your rolling tower (for pictures see page 82 onwards).

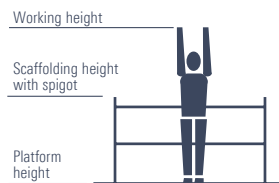
Tower model	Ref. No.	1403201	1403202 (3202)	1403203 (3203)	1403204 (3204)	1403205 (3205)	1403206 (3206)	1403207 (3207)
Guardrail 1.80 m	1205.180	0	4 (6)	9 (2)	8 (6)	13 (8)	12 (12)	17 (10)
Double guardrail 1.80 m	1206.180	2	0 (0)	0 (2)	0 (0)	0 (2)	0 (0)	0 (2)
Diagonal brace 2.50 m	1208.180	0	2 (2)	2 (2)	4 (4)	4 (4)	6 (6)	6 (6)
Diagonal brace 1.95 m	1208.195	0	0 (0)	2 (0)	0 (0)	2 (0)	0 (0)	2 (0)
Horizontal diagonal brace 1.95 m	1209.180	0	0 (0)	0 (0)	0 (1)	0 (1)	0 (1)	0 (1)
Basic tube 1.80 m	1211.180	0	1 (0)	1 (0)	1 (0)	1 (0)	1 (0)	1 (0)
Mobile beam 1.80 m without bar	1214.180	0	0 (2)	0 (2)	0 (2)	0 (2)	0 (2)	0 (2)
End toe board 0.75 m	1238.075	0	2 (2)	2 (2)	2 (2)	2 (2)	2 (2)	2 (2)
Toe board 1.80 m with claw	1239.180	0	2 (2)	2 (2)	2 (2)	2 (2)	2 (2)	2 (2)
Deck 1.80 m	1241.180	0	1 (0)	0 (0)	1 (0)	0 (0)	1 (0)	0 (0)
Access deck 1.80 m	1242.180	1	1 (1)	2 (1)	2 (1)	3 (2)	3 (2)	4 (2)
Spring clip 11 mm	1250.000	0	8 (8)	8 (8)	12 (12)	12 (12)	16 (16)	16 (16)
Ladder frame 75/4 – 1.00 m	1297.004	0	2 (2)	0 (0)	2 (2)	0 (0)	2 (2)	0 (0)
Ladder frame 75/8 – 2.00 m	1297.008	2	2 (2)	4 (4)	4 (4)	6 (6)	6 (6)	8 (8)
Castor 400 – 4 kN	1308.150	4	4 (4)	4 (4)	4 (4)	4 (4)	4 (4)	4 (4)
Mobile beam with bar	1323.180	0	2 (0)	2 (0)	2 (0)	2 (0)	2 (0)	2 (0)
Uni assembly hook	1300.001	0	1 (0)	1 (0)	1 (0)	1 (0)	1 (0)	1 (0)
Ballast	1249.000	For requirement see table below						



## The Uni Light family

Tower model			1403201	1403202 Safety structure P2	3202 Min. requirements DIN EN 1004	1403203 Safety structure P2	3203 Min. requirements DIN EN 1004
Working height [m]			3.11	4.26	4.26	5.26	5.26
Tower height [m]			2.33	3.48	3.48	4.48	4.48
Platform height [m]			1.11	2.26	2.26	3.26	3.26
Weight [kg] (without ballast)			52.3	133.1	110.4	159.7	120.6
<b>Ballast</b> (stated in units)							
<b>In closed areas</b>							
Assembly central*			l4 r4	0	0	0	4
Assembly off-set			X	0	2	LO R2	6
Assembly off-set with wall bracing			X	0	0	0	4
<b>Outdoors</b>							
Assembly central*			l4 r4	0	0	0	4
Assembly off-set			X	0	4	LO R4	8
Assembly off-set with wall bracing			X	0	0	0	4

\* Assembly with adjustable mobile beam, which must be fully extended. X = not possible/not permissible 0 = no ballast required

For ballasting, use Layher ballast weights, Ref. No. 1249.000, 10 kg each. These weights are attached quickly and securely at the right places using the star handle coupler.

All height dimensions are calculated without any spindle travel. The maximum spindle travel of each assembly variant is listed in its assembly instruction guide!

**Do not use any liquid or granular ballast materials. The ballast weight must be distributed evenly to all ballasting fixing points (see instructions for assembly and use).**

Example: l2, r2 → 2 ballast weights of 10 kg each must be fastened to the left-hand side of the ladder frame, and 2 ballast weights of 10 kg each to its right-hand side  
 l6, R16 → 6 ballast weights of 10 kg each must be fastened to the left-hand side of the mobile beam, and 16 ballast weights of 10 kg each to its right-hand side.  
 r and R always relate, in the case of off-centre assembly, to that side facing away from the scaffolding, l and L relate to the side facing the scaffolding (see instructions for assembly and use).



**Retrofitting Table**

Retrofitting the existing rolling tower to create the P2 design is possible using standard components of the Layher construction kit in the proven Layher quality.

Retrofit Set	Ref. No.	1400021	1400022	1400023	1400024	1400025	1400026
<i>for tower model</i>		<b>3202*</b>	<b>3203*</b>	<b>3204*</b>	<b>3205*</b>	<b>3206*</b>	<b>3207*</b>
Guardrail 1.80 m	1205.180	0	3	4	1	2	3
Diagonal brace 1.95 m	1208.195	0	2	0	2	0	2
Basic tube 1.80 m	1211.180	1	1	1	1	1	1
Deck 1.80 m	1241.180	0	0	0	0	0	0
Access deck 1.80 m	1242.180	0	1	1	1	1	2
Uni assembly hook	1300.001	1	1	1	1	1	1

\* If there are already mobile beams 1.80 m (1214.180) and/or double rear guardrails (1206.180) in your inventory, there's no need to replace them. They can still be used.

For compliance with the OH & S Layher recommends the safety structure P2.

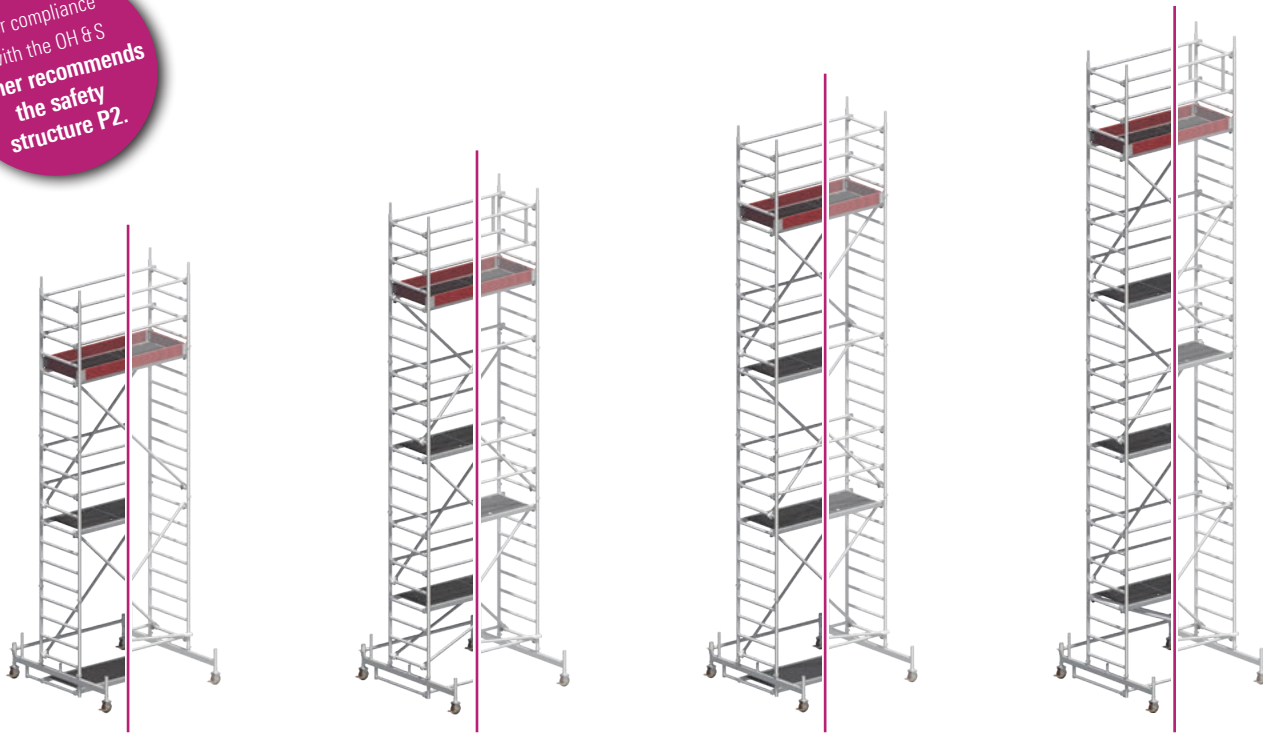

1403204 Safety structure P2	3204 Min. requirements DIN EN 1004	1403205 Safety structure P2	3205 Min. requirements DIN EN 1004	1403206 Safety structure P2	3206 Min. requirements DIN EN 1004	1403207 Safety structure P2	3207 Min. requirements DIN EN 1004
6.26	6.26	7.26	7.26	8.26	8.26	9.26	9.26
5.48	5.48	6.48	6.48	7.48	7.48	8.48	8.48
4.26	4.26	5.26	5.26	6.26	6.26	7.26	7.26
181.5	138.1	208.1	177.1	229.9	191.1	256.5	205.9
I2 r2	8	I3 r3	12	I5 r5	12	I6 r6	16
L0 R4	10	L0 R6	14	L2 R8	12	L2 R10	16
L2 R2	8	L4 R2	10	L6 R4	12	L6 R6	14
I3 r3	10	I5 r5	14	I9 r9	20	I13 r13	26
L0 R6	12	L0 R10	20	L4 R14	20	X	26
L4 R2	8	L6 R4	10	L10 R8	12	X	14

All dimensions and weights are guideline values. Subject to technical modification. Our deliveries shall be made exclusively in accordance with our currently valid General Terms of Sale. Title to the delivered goods shall be retained until full payment has been made. When purchasing, you receive instructions for assembly and use that must be followed without fail or assembly, dismantling and use.

## Uni Light with stabilizers, extendable

### Part list

The Layher modular system permits problem-free expansion of your rolling tower (for pictures see page 82 onwards).

Tower model	Ref. No.	1403223	1403224	1403225	1403226	1403227
Guardrail 1.80 m	1205.180	10	10	14	14	18
Diagonal brace 2.50 m	1208.180	2	4	4	6	6
Diagonal brace 1.95 m	1208.195	2	0	2	0	2
End toe board 0.75 m	1238.075	2	2	2	2	2
Toe board 1.80 m with claw	1239.180	2	2	2	2	2
Access deck 1.80 m	1242.180	2	2	3	3	4
Alu stabilizer, extendable	1248.260	4	4	4	4	4
Rotation preventer	1248.261	4	4	4	4	4
Spring clip 11 mm	1250.000	4	8	8	12	12
Ladder frame 75/4 – 1.00 m	1297.004	0	2	0	2	0
Ladder frame 75/8 – 2.00 m	1297.008	4	4	6	6	8
Uni Assembly hook	1300.001	1	1	1	1	1
Castor 400 – 4 kN	1308.150	4	4	4	4	4
Access ledger 0.30 m	1344.002	1	1	1	1	1
Ballast	1249.000	For requirement see table below				



### The Uni Light family with stabilizers

Tower model	1403223 Safety structure P2	1403224 Safety structure P2
Working height [m]	5.10	6.10
Tower height [m]	4.35	5.35
Platform height [m]	3.10	4.10
Weight [kg] (without ballast)	168.2	179.0
<b>Ballast</b> (stated in units)		
<b>In closed areas</b>		
Assembly central	0	0
Assembly off-set	L0 R4	L0 R8
Assembly off-set with wall bracing	0	0
<b>Outdoors</b>		
Assembly central	0	0
Assembly off-set	L0 R6	L0 R10
Assembly off-set with wall bracing	0	0

X = not possible/not permissible 0 = no ballast required

For ballasting, use Layher ballast weights, Ref. No. 1249.000, 10 kg each. These weights are attached quickly and securely at the right places using the star handle coupler.

All height dimensions are calculated without any spindle travel. The maximum spindle travel of each assembly variant is listed in its assembly instruction guide!

**Do not use any liquid or granular ballast materials. The ballast weight must be distributed evenly to all ballasting fixing points (see instructions for assembly and use).**

Example: L2, r2 → 2 ballast weights of 10 kg each must be fastened to the left-hand side of the ladder frame, and 2 ballast weights of 10 kg each to its right-hand side  
L6, R16 → 6 ballast weights of 10 kg each must be fastened to the left-hand side of the mobile beam, and 16 ballast weights of 10 kg each to its right-hand side.  
r and R always relate, in the case of off-centre assembly, to that side facing away from the scaffolding, l and L relate to the side facing the scaffolding (see instructions for assembly and use).

## Uni Light with stabilizers, extendable

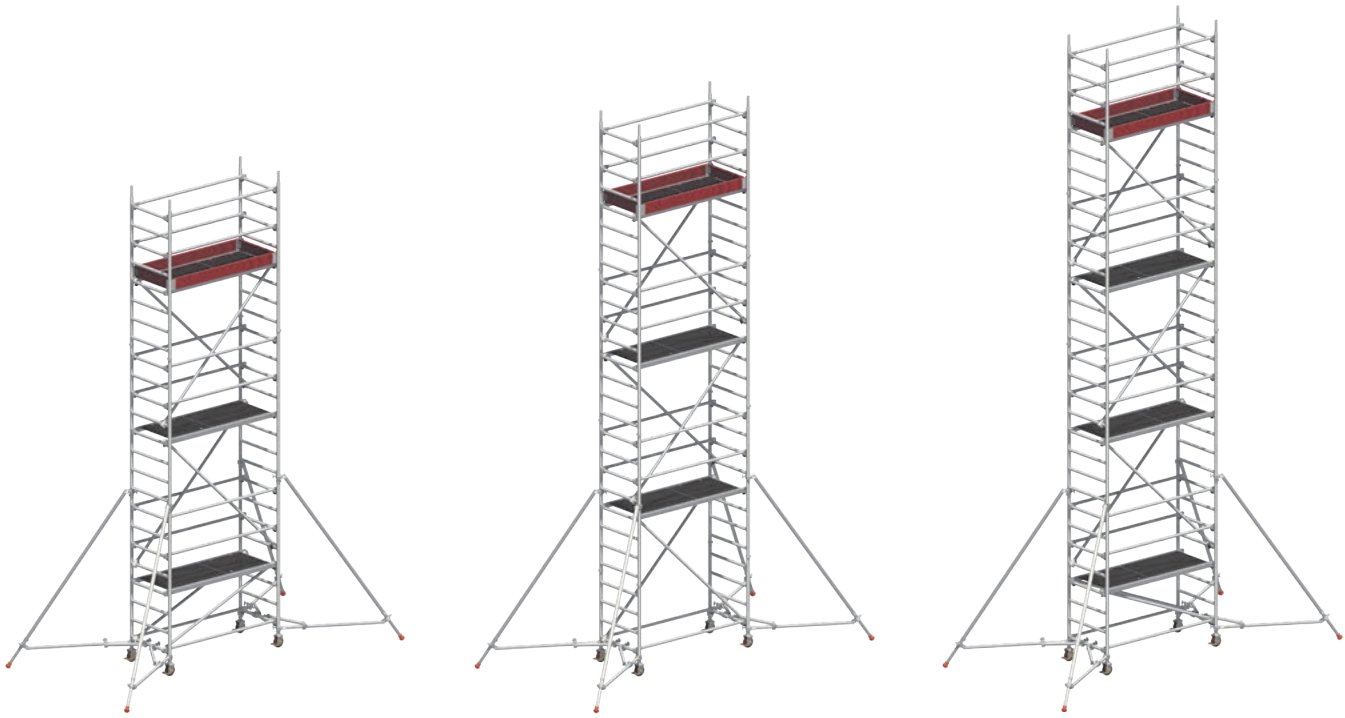

1403225 Safety structure P2	1403226 Safety structure P2	1403227 Safety structure P2
7.10	8.10	9.10
6.35	7.35	8.35
5.10	6.10	7.10
216.6	227.4	265.0
0	12 r2	12 r2
LO R10	LO R12	LO R14
0	0	0
13 r3	16 r6	18 r8
LO R14	X	X
0	0	12 r0

All dimensions and weights are guideline values. Subject to technical modification. Our deliveries shall be made exclusively in accordance with our currently valid General Terms of Sale. Title to the delivered goods shall be retained until full payment has been made. When purchasing, you receive instructions for assembly and use that must be followed without fail or assembly, dismantling and use.

## Uni Compact

# UNI COMPACT

THE "COMPACT UNIVERSAL TOWER" WITH DOUBLE-WIDTH WORKING SURFACE



**The universal tower with double-width working surface yet with compact basic dimensions – offering sufficient room for working at heights, even with materials, yet still leaving plenty of freedom to move.**

Ladder frames (1.50 m wide) of aluminium for push-fit assembly; rear guardrails and diagonal braces of aluminium snap in easily.

Work decks with aluminium frame and plywood insert, as a hatch-type deck for risk-free internal access.

Sturdy castors with concentric load transmission after locking for particular stability, long steel spindles for levelling.

Base widening: With mobile beam made of steel, telescoping for work on ceilings or walls to choice, only needed at working heights of 8.38 m and above.

The Uni Compact family can also be equipped with stabilizers. Learn more about that on page 56.

### TECHNICAL DATA

- ▶ Working height: 10.38 m
- ▶ Area of working platform: 1.50 x 1.80 m
- ▶ Permissible live load: 2 kN / m<sup>2</sup> (scaffolding group 3)



# Uni Compact



## Part list

The Layher modular system permits problem-free expansion of your rolling tower (for pictures see page 82 onwards).

Tower model	Ref. No.	1405001	1405002 (5002)	1405003 (5003)	1405004 (5004)	1405005 (5005)	1405006 (5006)	1405007 (5007)	1405008 (5008)
Guardrail 1.80 m	1205.180	0	6 (6)	10 (2)	10 (6)	14 (8)	12 (9)	17 (9)	16 (11)
Double guardrail 1.80 m	1206.180	2	0 (0)	0 (2)	0 (0)	0 (2)	0 (0)	0 (2)	0 (0)
Diagonal brace 2.50 m	1208.180	0	2 (2)	2 (2)	4 (4)	4 (4)	6 (6)	6 (6)	8 (8)
Diagonal brace 1.95 m	1208.195	0	0 (0)	2 (0)	0 (0)	2 (0)	0 (0)	2 (0)	0 (0)
Basic tube 1.80 m	1211.180	0	0 (0)	0 (0)	0 (0)	0 (0)	1 (0)	1 (0)	1 (0)
End toe board 1.50 m	1238.144	0	2 (2)	2 (2)	2 (2)	2 (2)	2 (2)	2 (2)	2 (2)
Toe board 1.80 m with claw	1239.180	0	2 (2)	2 (2)	2 (2)	2 (2)	2 (2)	2 (2)	2 (2)
Deck 1.80 m	1241.180	1	2 (1)	2 (1)	3 (1)	3 (2)	4 (2)	4 (2)	5 (2)
Access deck 1.80 m	1242.180	1	1 (1)	2 (1)	2 (1)	3 (2)	3 (2)	4 (2)	4 (2)
Spring clip 11 mm	1250.000	0	4 (4)	4 (4)	8 (8)	8 (8)	16 (16)	16 (16)	20 (20)
Castor 700 – 7 kN	1259.201	4	4 (4)	4 (4)	4 (4)	4 (4)	4 (4)	4 (4)	4 (4)
Ladder frame 150/4 – 1.00 m	1299.004	0	2 (2)	0 (0)	2 (2)	0 (0)	2 (2)	0 (0)	2 (2)
Ladder frame 150/8 – 2.00 m	1299.008	2	2 (2)	4 (4)	4 (4)	6 (6)	6 (6)	8 (8)	8 (8)
Mobile beam with bar adj.	1323.320	0	0 (0)	0 (0)	0 (0)	0 (0)	2 (2)	2 (2)	2 (2)
Base strut 1.80 m	1324.180	0	0 (0)	0 (0)	0 (0)	0 (0)	0 (1)	0 (1)	0 (1)
Access ledger 0.75 m	1344.003	0	2 (1)	1 (1)	2 (1)	1 (1)	0 (0)	0 (0)	0 (0)
Uni assembly hook	1300.001	0	1 (0)	1 (0)	1 (0)	1 (0)	1 (0)	1 (0)	1 (0)
Ballast	1249.000								For requirement see table below



## The Uni Compact family

Tower model	 	1405001	1405002 Safety structure P2	5002 Min. requirements DIN EN 1004	1405003 Safety structure P2	5003 Min. requirements DIN EN 1004
Working height [m]		3.20	4.20	4.20	5.20	5.20
Tower height [m]		2.43	3.43	3.43	4.43	4.43
Platform height [m]		1.20	2.20	2.20	3.20	3.20
Weight [kg] (without ballast)		94.0	152.5	134.6	192.0	150.0
<b>Ballast</b> (stated in units)						
<b>In closed areas</b>						
Assembly central*		0	11 r1	0	11 r1	4
Assembly off-set		X	X	X	X	X
Assembly off-set with wall bracing		0	12 r0	X	12 r0	X
<b>Outdoors</b>						
Assembly central*		0	11 r1	0	13 r3	6
Assembly off-set		X	X	X	X	X
Assembly off-set with wall bracing		0	12 r0	X	14 r0	X

\* Assembly with adjustable mobile beam, which must be fully extended. X = not possible/not permissible 0 = no ballast required

For ballasting, use Layher ballast weights, Ref. No. 1249.000, 10 kg each. These weights are attached quickly and securely at the right places using the star handle coupler. All height dimensions are calculated without any spindle travel. The maximum spindle travel of each assembly variant is listed in its assembly instruction guide!

**Do not use any liquid or granular ballast materials. The ballast weight must be distributed evenly to all ballasting fixing points (see instructions for assembly and use).**

Example: L2, r2 → 2 ballast weights of 10 kg each must be fastened to the left-hand side of the ladder frame, and 2 ballast weights of 10 kg each to its right-hand side  
L6, R16 → 6 ballast weights of 10 kg each must be fastened to the left-hand side of the mobile beam, and 16 ballast weights of 10 kg each to its right-hand side.  
r and R always relate, in the case of off-centre assembly, to that side facing away from the scaffolding; l and L relate to the side facing the scaffolding (see instructions for assembly and use).

**Retrofitting table**

Retrofitting the existing rolling tower to create the P2 design is possible using standard components of the Layher construction kit in the proven Layher quality.

Retrofit set	Ref. No.	1400027	1400028	1400029	1400030	1400031	1400032	1400033
<i>for tower model</i>		<b>5002</b>	<b>5003</b>	<b>5004</b>	<b>5005</b>	<b>5006*</b>	<b>5007*</b>	<b>5008*</b>
Guardrail 1.80 m	1205.180	0	4	4	2	3	4	5
Diagonale brace 1.95 m	1208.195	0	2	0	2	0	2	0
Deck 1.80 m	1241.180	1	1	2	1	2	2	3
Access deck 1.80 m	1242.180	0	1	1	1	1	2	2
Access ledger 0.75 m	1344.003	1	0	1	0	0	0	0
Uni assembly hook	1300.001	1	1	1	1	1	1	1

\* If there is already a base strut (1324.180) and/or double rear guardrails (1206.180) in your inventory, there's no need to replace them. They can still be used.

For compliance with the OH & S Layher recommends the safety structure P2.

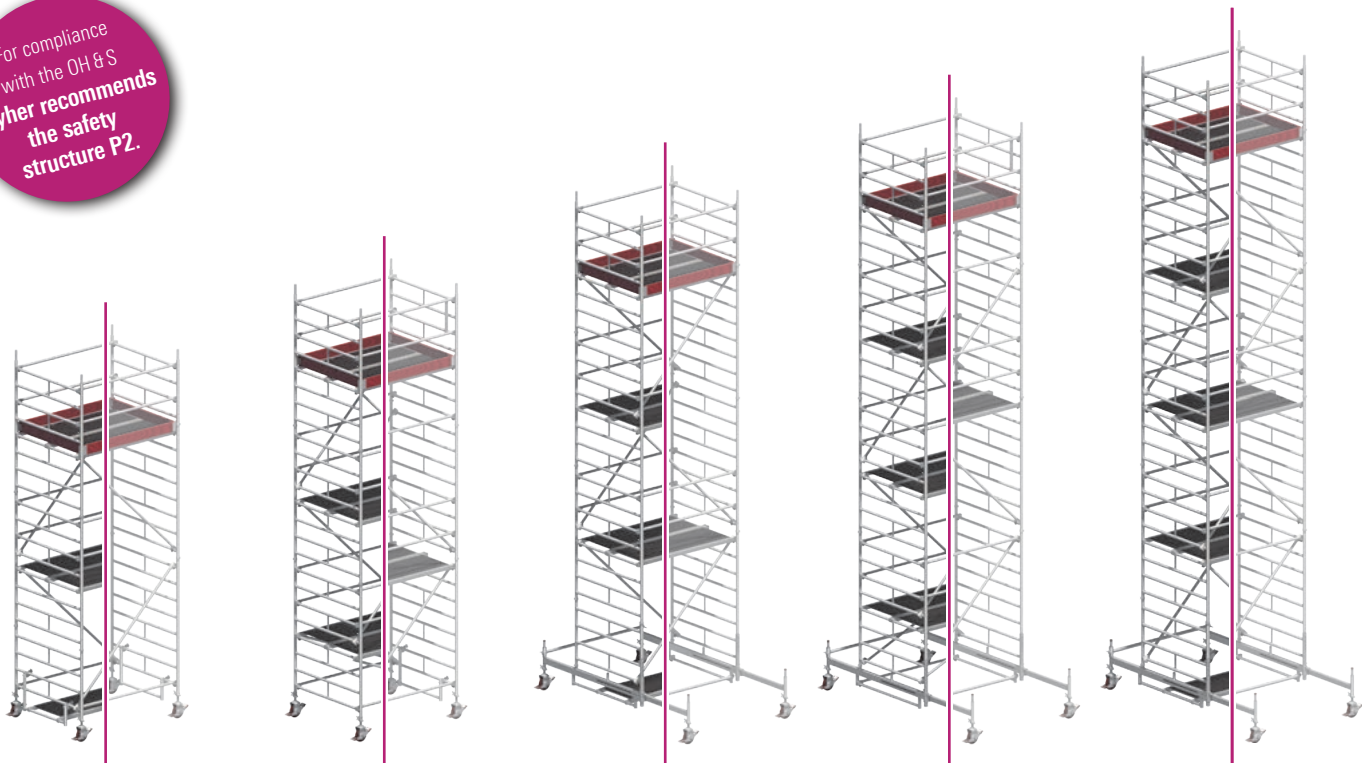

1405004 Safety structure P2	5004 Min. requirements DIN EN 1004	1405005 Safety structure P2	5005 Min. requirements DIN EN 1004	1405006 Safety structure P2	5006 Min. requirements DIN EN 1004	1405007 Safety structure P2	5007 Min. requirements DIN EN 1004	1405008 Safety structure P2	5008 Min. requirements DIN EN 1004
6.20	6.20	7.20	7.20	8.38	8.38	9.38	9.38	10.38	10.38
5.43	5.43	6.43	6.43	7.61	7.61	8.61	8.61	9.61	9.61
4.20	4.20	5.20	5.20	6.38	6.38	7.38	7.38	8.38	8.38
224.0	168.6	263.5	226.1	377.4	326.1	422.5	350.7	448.9	364.7
14 r4	8	14 r4	8	0	0	0	4	11 r1	6
X	X	X	X	0	0	0	4	11 r1	8
14 r0	X	14 r0	X	0	0	0	4	11 r1	8
17 r7	14	111 r11	20	113 r13	24	117 r17	36	X	X
X	X	X	X	113 r13	24	117 r17	36	X	X
110 r4	X	114 r4	X	113 r13	24	117 r17	36	X	X

All dimensions and weights are guideline values. Subject to technical modification. Our deliveries shall be made exclusively in accordance with our currently valid General Terms of Sale. Title to the delivered goods shall be retained until full payment has been made. When purchasing, you receive instructions for assembly and use that must be followed without fail or assembly, dismantling and use.

## Uni Compact with stabilizers, extendable

### Part list

The Layher modular system permits problem-free expansion of your rolling tower (for pictures see page 82 onwards).

Tower model	Ref. No.	1405024	1405025	1405026	1405027	1405028
Guardrail 1.80 m	1205.180	10	14	14	18	18
Diagonal brace 2.50 m	1208.180	4	4	6	6	8
Diagonal brace 1.95 m	1208.195	0	2	0	2	0
End toe board 0.75 m	1238.144	2	2	2	2	2
Toe board 1.80 m with claw	1239.180	2	2	2	2	2
Access deck 1.80 m	1241.180	2	3	3	4	4
Access ledger 1.8 m	1242.180	2	3	3	4	4
Alu stabilizer, extendable	1248.260	4	4	4	4	4
Rotation preventer	1248.261	4	4	4	4	4
Spring clip 11 mm	1250.000	8	8	12	12	16
Ladder frame 75/4 – 1.00 m	1299.004	2	0	2	0	2
Ladder frame 75/8 – 2.00 m	1299.008	4	6	6	8	8
Uni Assembly hook	1300.001	1	1	1	1	1
Castor 400 – 4 kN	1259.201	4	4	4	4	4
Access ledger 0.30 m	1344.003	1	1	1	1	1
Ballast	1249.000	For requirement see table below				



### The Uni Compact family with stabilizers

Tower model	1405024 Safety structure P2	1405025 Safety structure P2
Working height [m]	6.20	7.20
Tower height [m]	5.45	6.45
Platform height [m]	4.20	5.20
Weight [kg] (without ballast)	252.6	308.7
<b>Ballast</b> (stated in units)		
<b>In closed areas</b>		
Assembly central	0	0
Assembly off-set	L0 R2	L0 R2
Assembly off-set with wall bracing	0	0
<b>Outdoors</b>		
Assembly central	l2 r2	l4 r4
Assembly off-set	L0 R4	L0 R6
Assembly off-set with wall bracing	0	0

\* Assembly with adjustable mobile beam, which must be fully extended. X = not possible/not permissible 0 = no ballast required

For ballasting, use Layher ballast weights, Ref. No. 1249.000, 10 kg each. These weights are attached quickly and securely at the right places using the star handle coupler. All height dimensions are calculated without any spindle travel. The maximum spindle travel of each assembly variant is listed in its assembly instruction guide!

**Do not use any liquid or granular ballast materials. The ballast weight must be distributed evenly to all ballasting fixing points (see instructions for assembly and use).**

Example: l2, r2 → 2 ballast weights of 10 kg each must be fastened to the left-hand side of the ladder frame, and 2 ballast weights of 10 kg each to its right-hand side  
 L6, R16 → 6 ballast weights of 10 kg each must be fastened to the left-hand side of the mobile beam, and 16 ballast weights of 10 kg each to its right-hand side.  
 r and R always relate, in the case of off-centre assembly, to that side facing away from the scaffolding; l and L relate to the side facing the scaffolding (see instructions for assembly and use).



## Uni Compact with stabilizers, extendable

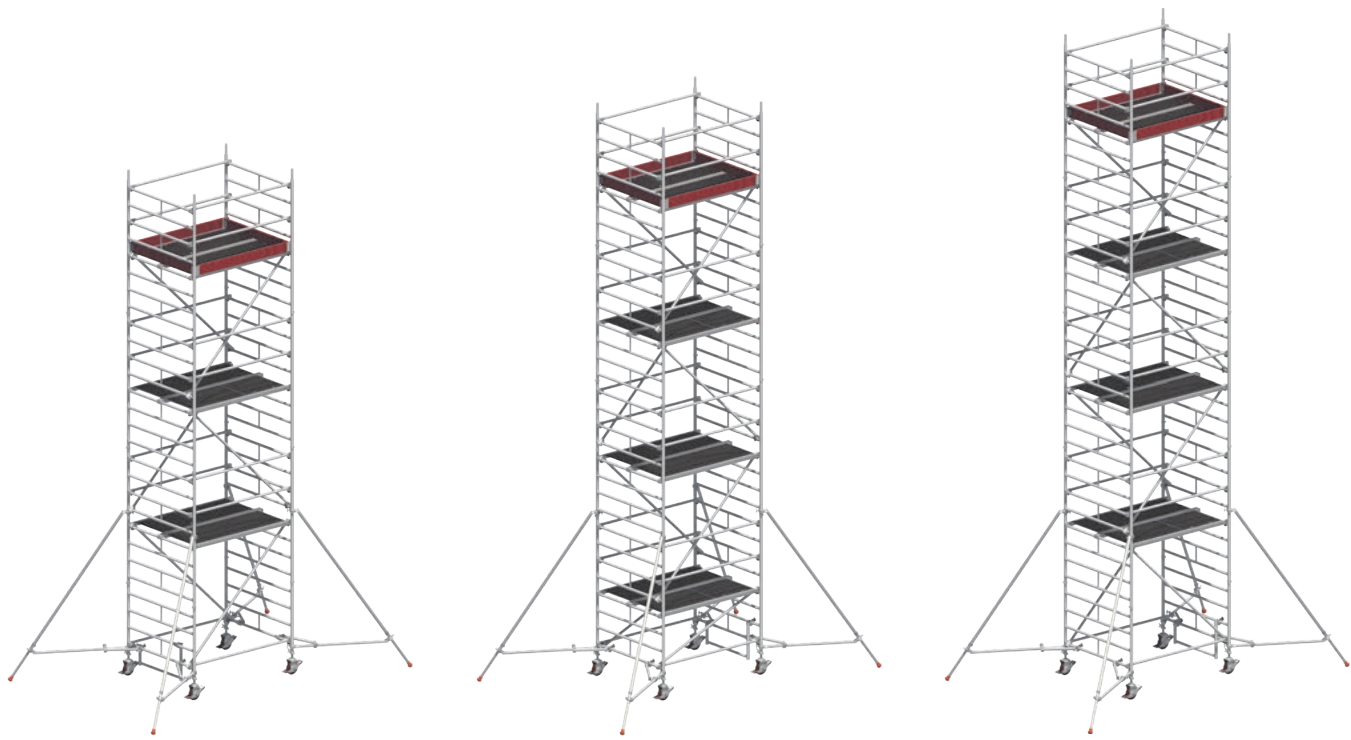

1405026 Safety structure P2	1405027 Safety structure P2	1405028 Safety structure P2
8.20	9.20	10.20
7.45	8.45	9.45
6.20	7.20	8.20
324.1	380.2	395.6
0	0	0
L0 R4	L0 R4	L0 R6
0	0	0
19 r9	112 r12	X
L0 R10	L0 R14	X
0	0	X

All dimensions and weights are guideline values. Subject to technical modification. Our deliveries shall be made exclusively in accordance with our currently valid General Terms of Sale. Title to the delivered goods shall be retained until full payment has been made. When purchasing, you receive instructions for assembly and use that must be followed without fail or assembly, dismantling and use.

## Uni Standard

# UNI STANDARD

THE "MOST FLEXIBLE ROLLING TOWER" FOR VERY GREAT HEIGHTS



**For work on walls and ceilings, on machinery, in technical plant, factories and warehouses, indoors and outdoors.**

Ladder frames of aluminium for push-fit assembly; rear guardrails and diagonal braces of aluminium snap in easily.

Work decks with aluminium frame and plywood insert, also as a hatch-type deck for risk-free internal access.

Sturdy castors with concentric load transmission after locking for particular stability, long steel spindles for levelling.

Base widening: With mobile beam made of steel, rigid or telescopic, with spigots for optional mounting of ladder frames for work on ceilings and walls; alternatively with stabilizers see page 62.

### TECHNICAL DATA

- ▶ Working height: 13.38 m
- ▶ Area of working platform: 0.75 x 2.85 m
- ▶ Permissible live load: 2 kN / m<sup>2</sup> (scaffolding group 3)

### Convenient access

For even more safety and even more convenient access, the Uni Standard P2 can also be supplied with suspended ladders with wide steps.

For requirement see page 60.

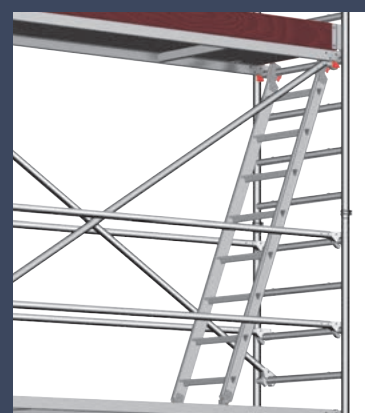



## Uni Standard

### Part list

The Layher modular system permits problem-free expansion of your rolling tower (for pictures see page 82 onwards).

Tower model	Ref. No.	1401101	1401102 (1102)	1401103 (1103)	1401104 (1104)	1401105 (1105)	1401106 (1106)	1401107 (1107)	1401108 (1108)	1401109 (1109)	1401110 (1110)	1401111 (1111)
Guardrail 2.85 m	1205.285	0	4 (5)	9 (1)	8 (5)	13 (7)	12 (9)	17 (9)	16 (11)	21 (13)	20 (15)	25 (15)
Double guardrail 2.85 m	1206.285	2	0 (0)	0 (2)	0 (0)	0 (2)	0 (0)	0 (2)	0 (0)	0 (2)	0 (0)	0 (2)
Diagonal brace 3.35 m	1208.285	0	2 (2)	2 (2)	4 (4)	4 (4)	6 (6)	6 (6)	8 (8)	8 (8)	10 (10)	10 (10)
Diagonal brace 2.95 m	1208.295	0	0 (0)	2 (0)	0 (0)	2 (0)	0 (0)	2 (0)	0 (0)	2 (0)	0 (0)	2 (0)
Basic tube 2.85 m	1211.285	0	1 (0)	1 (0)	1 (0)	1 (0)	1 (0)	1 (0)	1 (0)	1 (0)	1 (0)	1 (0)
End toe board 0.75 m	1238.075	0	2 (2)	2 (2)	2 (2)	2 (2)	2 (2)	2 (2)	2 (2)	2 (2)	2 (2)	2 (2)
Toe board 2.85 m with claw	1239.285	0	2 (2)	2 (2)	2 (2)	2 (2)	2 (2)	2 (2)	2 (2)	2 (2)	2 (2)	2 (2)
Deck 2.85 m	1241.285	0	1 (0)	0 (0)	1 (0)	0 (0)	1 (0)	0 (0)	1 (0)	0 (0)	1 (0)	0 (0)
Access deck 2.85 m	1242.285	1	1 (1)	2 (1)	2 (1)	3 (2)	3 (2)	4 (2)	4 (2)	5 (3)	5 (3)	6 (3)
Spring clip 11 mm	1250.000	0	8 (8)	8 (8)	12 (12)	12 (12)	16 (16)	16 (16)	20 (20)	20 (20)	24 (24)	24 (24)
Castor 700 – 7 kN	1259.201	4	4 (4)	4 (4)	4 (4)	4 (4)	4 (4)	4 (4)	4 (4)	4 (4)	4 (4)	4 (4)
Ladder frame 75/4 – 1.00 m	1297.004	0	2 (2)	0 (0)	2 (2)	0 (0)	2 (2)	0 (0)	2 (2)	0 (0)	2 (2)	0 (0)
Ladder frame 75/8 – 2.00 m	1297.008	2	2 (2)	4 (4)	4 (4)	6 (6)	6 (6)	8 (8)	8 (8)	10 (10)	10 (10)	12 (12)
Mobile beam with bar	1323.180	0	2 (2)	2 (2)	2 (2)	2 (2)	2 (2)	0 (0)	0 (0)	0 (0)	0 (0)	0 (0)
Mobile beam with bar adj.	1323.320	0	0 (0)	0 (0)	0 (0)	0 (0)	0 (0)	2 (2)	2 (2)	2 (2)	2 (2)	2 (2)
Base strut 2.85 m	1324.285	0	0 (1)	0 (1)	0 (1)	0 (1)	0 (1)	0 (1)	0 (1)	0 (1)	0 (1)	0 (1)
Uni assembly hook	1300.001	0	1 (0)	1 (0)	1 (0)	1 (0)	1 (0)	1 (0)	1 (0)	1 (0)	1 (0)	1 (0)
Ballast	1249.000	For requirement see table below										

### Extra requirement for suspended step ladders – usable for safety structure P2

Tower model	Ref. No.	1401101	1401102	1401103	1401104	1401105	1401106	1401107	1401108	1401109	1401110	1401111
Suspended ladder, 8 rungs	1314.108	0	1	1	2	2	3	3	4	4	5	5
Ladder support set for 1314.108	1314.109	0	1	0	1	0	1	0	1	0	1	0

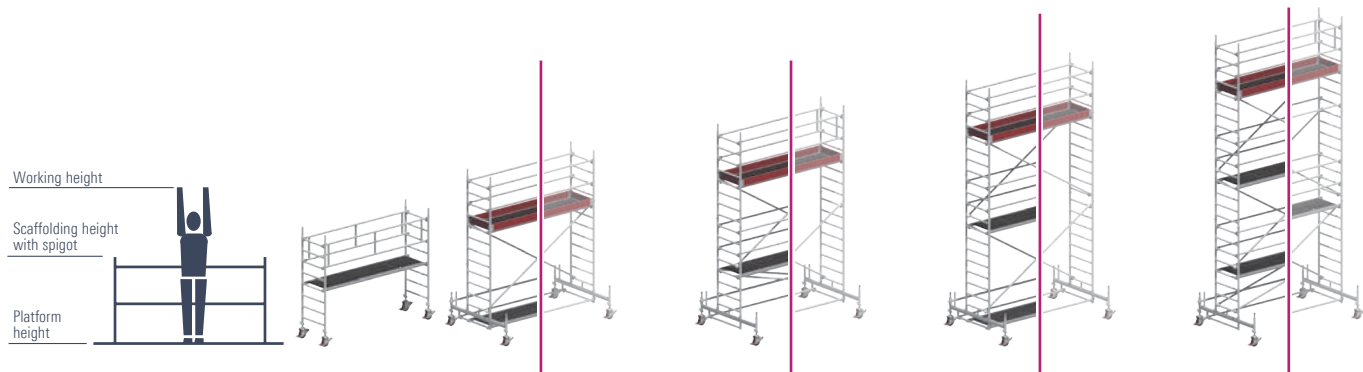

### The Uni Standard family

Tower model	1401101	1401102 Safety structure P2	1102 Min. requirements DIN EN 1004	1401103 Safety structure P2	1103 Min. requirements DIN EN 1004	1401104 Safety structure P2	1104 Min. requirements DIN EN 1004	1401105 Safety structure P2	1105 Min. requirements DIN EN 1004
Working height [m]	3.20	4.35	4.35	5.35	5.35	6.35	6.35	7.35	7.35
Tower height [m]	2.43	3.58	3.58	4.58	4.58	5.58	5.58	6.58	6.58
Platform height [m]	1.20	2.35	2.35	3.35	3.35	4.35	4.35	5.35	5.35
Weight [kg] (without ballast)	81.9	181.5	161.0	216.4	170.4	243.3	186.8	278.2	239.4
<b>Ballast (stated in units)</b>									
<b>In closed areas</b>									
Assembly central*	I2 r2	0	0	0	0	0	0	0	0
Assembly off-set	X	0	0	0	10 r2	L0 R4	10 r4	L0 R4	10 r5
Assembly off-set with wall bracing	X	0	0	0	0	0	0	0	0
Assembly central with 1 bracket*	X	0	0	0	L0 R8	L0 R2	L0 R4	L0 R4	L0 R4
Assembly central with 2 brackets*	X	0	0	0	0	0	0	0	0
<b>Outdoors</b>									
Assembly central*	I2 r2	0	0	11 r1	10 r1	15 r5	14 r4	19 r9	19 r9
Assembly off-set	X	L0 R2	0	L0 R6	10 r5	L0 R10	10 r9	L4 R16	12 r14
Assembly off-set with wall bracing	X	0	0	0	0	0	0	L4 R0	12 r0
Assembly central with 1 bracket*	X	L0 R4	L0 R4	L0 R8	L0 R8	L2 R12	L2 R12	L6 R16	L6 R16
Assembly central with 2 brackets*	X	I2 r2	X	15 r5	X	18 r8	X	X	X

\* Assembly with adjustable mobile beam, which must be fully extended. X = not possible/not permissible 0 = no ballast required

For ballasting, use Layher ballast weights, Ref. No. 1249.000, 10 kg each. These weights are attached quickly and securely at the right places using the star handle coupler.

All height dimensions are calculated without any spindle travel. The maximum spindle travel of each assembly variant is listed in its assembly instruction guide!

**Do not use any liquid or granular ballast materials. The ballast weight must be distributed evenly to all ballasting fixing points (see instructions for assembly and use).**

Example:

I2, r2 → 2 ballast weights of 10 kg each must be fastened to the left-hand side of the ladder frame, and 2 ballast weights of 10 kg each to its right-hand side  
L6, R16 → 6 ballast weights of 10 kg each must be fastened to the left-hand side of the mobile beam, and 6 ballast weights of 10 kg each to its right-hand side.

r and R always relate, in the case of off-centre assembly, to that side facing away from the scaffolding; l and L relate to the side facing the scaffolding (see instructions for assembly and use).

**Retrofitting table**

Retrofitting the existing rolling tower to create the P2 design is possible using standard components of the Layher construction kit in the proven Layher quality.

Retrofit set	Ref. No.	1400001	1400002	1400003	1400004	1400005	1400006	1400007	1400008	1400009	1400010
<i>for tower model</i>		<b>1102*</b>	<b>1103*</b>	<b>1104*</b>	<b>1105*</b>	<b>1106*</b>	<b>1107*</b>	<b>1108*</b>	<b>1109*</b>	<b>1110*</b>	<b>1111*</b>
Guardrail 2.85 m	1205.285	0	4	3	2	3	4	5	4	5	6
Diagonal brace 2.95 m	1208.295	0	2	0	2	0	2	0	2	0	2
Deck 2.85 m	1241.285	1	0	1	0	1	0	1	0	1	0
Access deck 2.85 m	1242.285	0	1	1	1	1	2	2	2	2	3
Uni assembly hook	1300.001	1	1	1	1	1	1	1	1	1	1

\* If there is already a base strut (1324.285) and/ or double rear guardrails (1206.285) in your inventory, there's no need to replace them. They can still be used.

For compliance with the OH & S Layher recommends the safety structure P2.



1401106 Safety structure P2	1106 Min. requirements DIN EN 1004	1401107 Safety structure P2	1107 Min. requirements DIN EN 1004	1401108 Safety structure P2	1108 Min. requirements DIN EN 1004	1401109 Safety structure P2	1109 Min. requirements DIN EN 1004	1401110 Safety structure P2	1110 Min. requirements DIN EN 1004	1401111 Safety structure P2	1111 Min. requirements DIN EN 1004
8.35	8.35	9.38	9.38	10.38	10.38	11.38	11.38	12.38	12.38	13.38	13.38
7.58	7.58	8.61	8.61	9.61	9.61	10.61	10.61	11.61	11.61	12.61	12.61
6.35	6.35	7.38	7.38	8.38	8.38	9.38	9.38	10.38	10.38	11.38	11.38
305.1	248.6	391.2	323.6	418.1	332.8	453.0	385.4	479.9	394.6	514.8	418.4
0	I2 r2	0	0	0	0	0	0	0	0	0	0
LO R6	IO r8	LO R4	LO R6	LO R6	LO R8	LO R6	LO R9	LO R8	LO R10	LO R10	LO R12
0	0	0	0	0	0	0	0	0	0	0	0
LO R6	LO R8	0	0	0	0	0	0	0	0	0	0
0	I2 r2	0	0	0	0	0	0	0	X	0	X
I15 r15	I12 r13	I2 r2	L1 R1	X	X	X	X	X	X	X	X
L10 R22	I6 r18	LO R18	LO R17	X	X	X	X	X	X	X	X
L10 R0	I6 r0	0	L1 R0	X	X	X	X	X	X	X	X
L12 R22	L10 R20	X	0	X	0	X	0	X	X	X	X
X	X	X	X	X	X	X	X	X	X	X	X

All dimensions and weights are guideline values. Subject to technical modification. Our deliveries shall be made exclusively in accordance with our currently valid General Terms of Sale. Title to the delivered goods shall be retained until full payment has been made. When purchasing, you receive instructions for assembly and use that must be followed without fail or assembly, dismantling and use.

## Uni Standard with stabilizers

### Part list

The Layher modular system permits problem-free expansion of your rolling tower (for pictures see page 82 onwards).

		Uni Standard P2 with stabilizers, extendable							
Tower model	Ref. No.	1401124	1401125	1401126	1401127	1401128	1401129	1401130	1401131
Guardrail 2.85 m	1205.285	10	14	14	18	18	22	22	26
Diagonal brace 3.35 m	1208.285	4	4	6	6	8	8	10	10
Diagonal brace 2.95 m	1208.295	0	2	0	2	0	2	0	2
End toe board 0.75 m	1238.075	2	2	2	2	2	2	2	2
Toe board 2.85 m with claw	1239.285	2	2	2	2	2	2	2	2
Access deck 2,85 m	1242.285	2	3	3	4	4	5	5	6
Stabilizer, extendable	1248.260	4	4	4	4	4	4	4	4
Rotation preventer	1248.261	4	4	4	4	4	4	4	4
Stabilizer, 5 m	1248.500	0	0	0	0	0	0	0	0
Spring clip 11 mm	1250.000	8	8	12	12	16	16	20	20
Castor 700 – 7 kN	1259.201	4	4	4	4	4	4	4	4
Ladder frame 75/4 –1.00 m	1297.004	2	0	2	0	2	0	2	0
Ladder frame 75/8 –2.00 m	1297.008	4	6	6	8	8	10	10	12
Access ledger	1344.002	1	1	1	1	1	1	1	1
Uni Assembly hook	1300.001	1	1	1	1	1	1	1	1
Ballast	1249.000	For requirement see table below							

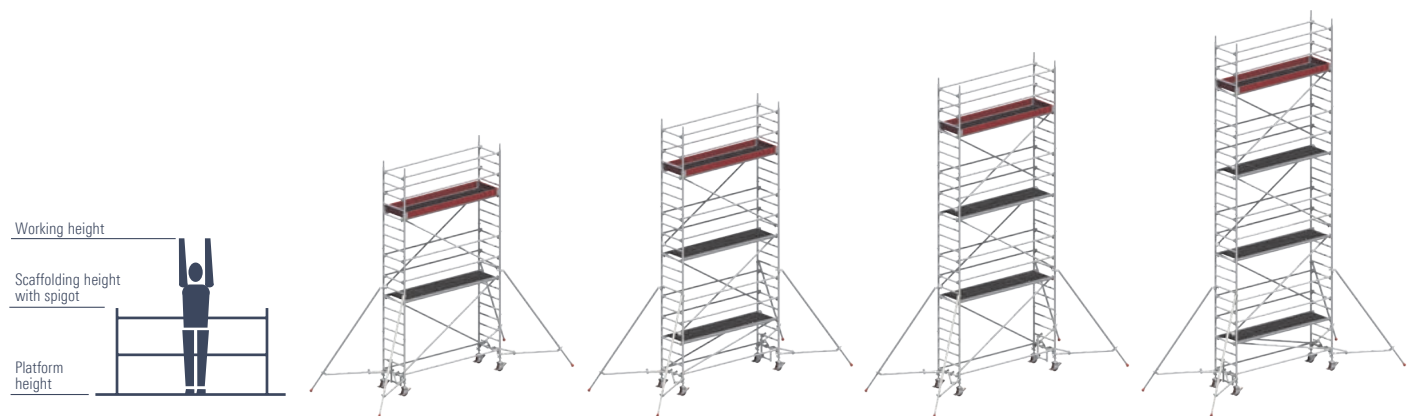

### The Uni Standard family with stabilizers, extendable

Tower model	1401124 Safety structure P2	1401125 Safety structure P2	1401126 Safety structure P2	1401127 Safety structure P2
Working height [m]	6.20	7.20	8.20	9.20
Tower height [m]	5.43	6.43	7.43	8.43
Standing height [m]	4.20	5.20	6.20	7.20
Weight [kg] (without ballast)	232.2	283.5	294.0	345.3
<b>Ballast</b> (stated in units)				
<b>In closed areas</b>				
Assembly central	0	0	0	0
Assembly off-set	LO R6	LO R8	LO 12R	LO R12
Assembly off-set with wall bracing	0	0	0	0
<b>Outdoors</b>				
Assembly central	0	0	0	0
Assembly off-set	LO R16	LO R20	LO R28	LO R34
Assembly off-set with wall bracing	0	0	0	0

X = not possible / not permissible 0 = no ballast required

For ballasting, use Layher ballast weights, Ref. No. 1249.000, 10 kg each. These weights are attached quickly and securely at the right places using the star handle coupler.

All height dimensions are calculated without any spindle travel. The maximum spindle travel of each assembly variant is listed in its assembly instruction guide!

**Do not use any liquid or granular ballast materials. The ballast weight must be distributed evenly to all ballasting fixing points (see instructions for assembly and use).**

Example: r2, r2 → 2 ballast weights of 10 kg each must be fastened to the left-hand side of the ladder frame, and 2 ballast weights of 10 kg each to its right-hand side  
 L6, R16 → 6 ballast weights of 10 kg each must be fastened to the left-hand side of the mobile beam, and 16 ballast weights of 10 kg each to its right-hand side.  
 r and R always relate, in the case of off-centre assembly, to that side facing away from the scaffolding; l and L relate to the side facing the scaffolding (see instructions for assembly and use).

## Uni Standard with stabilizers

### Uni Standard P2 with stabilizers, 5 m

1401145	1401146	1401147	1401148	1401149	1401150	1401151
14	14	18	18	22	22	26
4	6	6	8	8	10	10
2	0	2	0	2	0	2
2	2	2	2	2	2	2
2	2	2	2	2	2	2
3	3	4	4	5	5	6
0	0	0	0	0	0	0
4	4	4	4	4	4	4
4	4	4	4	4	4	4
8	12	12	16	16	20	20
4	4	4	4	4	4	4
0	2	0	2	0	2	0
6	6	8	8	10	10	12
1	1	1	1	1	1	1
1	1	1	1	1	1	1

For requirement see table on the right

1401145 Safety structure P2	1401146 Safety structure P2	1401147 Safety structure P2	1401148 Safety structure P2	1401149 Safety structure P2	1401150 Safety structure P2	1401151 Safety structure P2
7.20	8.20	9.20	10.20	11.20	12.20	13.20
6.43	7.43	8.43	9.43	10.43	11.43	12.43
5.20	6.20	7.20	8.20	9.20	10.20	11.20
309.1	319.6	370.9	381.4	432.7	443.2	494.5
0	0	0	0	0	0	0
LO R6	LO R8	LO R8	LO R10	LO R12	LO R14	LO R14
0	0	0	0	0	0	0
0	0	0	X	X	X	X
LO R16	LO R20	X	X	X	X	X
0	0	0	X	X	X	X

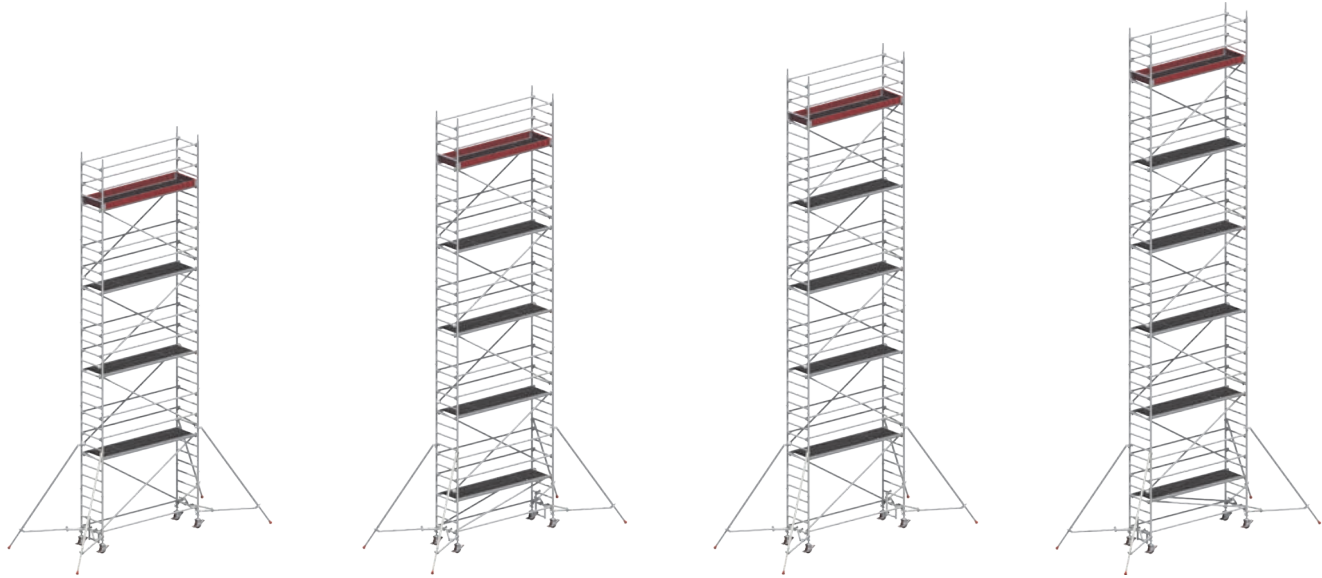

1401128 Safety structure P2	1401129 Safety structure P2	1401130 Safety structure P2	1401131 Safety structure P2
10.20	11.20	12.20	13.20
9.43	10.43	11.43	12.43
8.20	9.20	10.20	11.20
355.8	407.1	417.6	468.9
0	0	0	0
LO R16	LO R18	LO R20	LO R22
0	0	0	0
X	X	X	X
X	X	X	X
X	X	X	X

All dimensions and weights are guideline values. Subject to technical modification. Our deliveries shall be made exclusively in accordance with our currently valid General Terms of Sale. Title to the delivered goods shall be retained until full payment has been made. When purchasing, you receive instructions for assembly and use that must be followed without fail or assembly, dismantling and use.

## Uni Wide

# UNI WIDE

THE UNIVERSAL TOWER WITH "DOUBLE-WIDTH" WORKING SURFACE



**The universal tower with double-width working surface provides a comfortable workplace at great heights.**

Ideal for working with bulky materials while assuring the necessary freedom of movement.

Ladder frames (1.50 m wide) of aluminium for push-fit assembly; rear guard-rails and diagonal braces of aluminium snap in easily.

Work decks with aluminium frame and plywood insert, as a hatch-type deck for risk-free internal access.

Sturdy castors with concentric load transmission after locking for particular stability, long steel spindles for levelling.

Base widening: With mobile beam made of steel, telescopic for work on ceilings and walls if required; only necessary for working height of 8.60 m and above, alternatively with stabilizers (see page 68 in this respect and also instructions for assembly and use).

### TECHNICAL DATA

- ▶ Working height: 13.38 m
- ▶ Area of working platform: 1.50 x 2.85 m
- ▶ Permissible live load: 2 kN / m<sup>2</sup> (scaffolding group 3)

### Convenient access

For even more safety and even more convenient access, the Uni Wide P2 can also be supplied with suspended ladders with wide steps.

For requirement see page 66.







## Uni Wide

### Part list

The Layher modular system permits problem-free expansion of your rolling tower (for pictures see page 82 onwards).



Tower model	Ref. No.	1402101	1402102 (2102)	1402103 (2103)	1402104 (2104)	1402105 (2105)	1402106 (2106)	1402107 (2107)	1402108 (2108)	1402109 (2109)	1402110 (2110)	1402111 (2111)
Guardrail 2.85 m	1205.285	0	6 (6)	10 (2)	10 (6)	14 (8)	12 (9)	17 (9)	16 (11)	21 (13)	20 (15)	25 (15)
Double guardrail 2.85 m	1206.285	2	0 (0)	0 (2)	0 (0)	0 (2)	0 (0)	0 (2)	0 (0)	0 (2)	0 (0)	0 (2)
Diagonal brace 3.35 m	1208.285	0	2 (2)	2 (2)	4 (4)	4 (4)	6 (6)	6 (6)	8 (8)	8 (8)	10 (10)	10 (10)
Diagonal brace 2.95 m	1208.295	0	0 (0)	2 (0)	0 (0)	2 (0)	0 (0)	2 (0)	0 (0)	2 (0)	0 (0)	2 (0)
Basic tube 2.85 m	1211.285	0	0 (0)	0 (0)	0 (0)	0 (0)	1 (0)	1 (0)	1 (0)	1 (0)	1 (0)	1 (0)
End toe board 1.44 m	1238.144	0	2 (2)	2 (2)	2 (2)	2 (2)	2 (2)	2 (2)	2 (2)	2 (2)	2 (2)	2 (2)
Toe board 2.85 m with claw	1239.285	0	2 (2)	2 (2)	2 (2)	2 (2)	2 (2)	2 (2)	2 (2)	2 (2)	2 (2)	2 (2)
Deck 2.85 m	1241.285	1	2 (1)	2 (1)	3 (1)	3 (2)	4 (2)	4 (2)	5 (2)	5 (3)	6 (3)	6 (3)
Access deck 2.85 m	1242.285	1	1 (1)	2 (1)	2 (1)	3 (2)	3 (2)	4 (2)	4 (2)	5 (3)	5 (3)	6 (3)
Spring clip 11 mm	1250.000	0	4 (4)	4 (4)	8 (8)	8 (8)	16 (16)	16 (16)	20 (20)	20 (20)	24 (24)	24 (24)
Castor 700 – 7 kN	1259.201	4	4 (4)	4 (4)	4 (4)	4 (4)	4 (4)	4 (4)	4 (4)	4 (4)	4 (4)	4 (4)
Ladder frame 150/4 – 1.00 m	1299.004	0	2 (2)	0 (0)	2 (2)	0 (0)	2 (2)	0 (0)	2 (2)	0 (0)	2 (2)	0 (0)
Ladder frame 150/8 – 2.00 m	1299.008	2	2 (2)	4 (4)	4 (4)	6 (6)	6 (6)	8 (8)	8 (8)	10 (10)	10 (10)	12 (12)
Mobile beam with bar adj.	1323.320	0	0 (0)	0 (0)	0 (0)	0 (0)	2 (2)	2 (2)	2 (2)	2 (2)	2 (2)	2 (2)
Access ledger 0.75 m	1344.003	0	2 (1)	1 (1)	2 (1)	1 (1)	0 (0)	0 (0)	0 (0)	0 (0)	0 (0)	0 (0)
Uni assembly hook	1300.001	0	1 (0)	1 (0)	1 (0)	1 (0)	1 (0)	1 (0)	1 (0)	1 (0)	1 (0)	1 (0)
Base strut 2.85 m	1324.285	0	0 (0)	0 (0)	0 (0)	0 (0)	0 (1)	0 (1)	0 (1)	0 (1)	0 (1)	0 (1)
Ballast	1249.000	For requirement see table below										

### Extra requirement for suspended step ladders – usable for safety structure P2

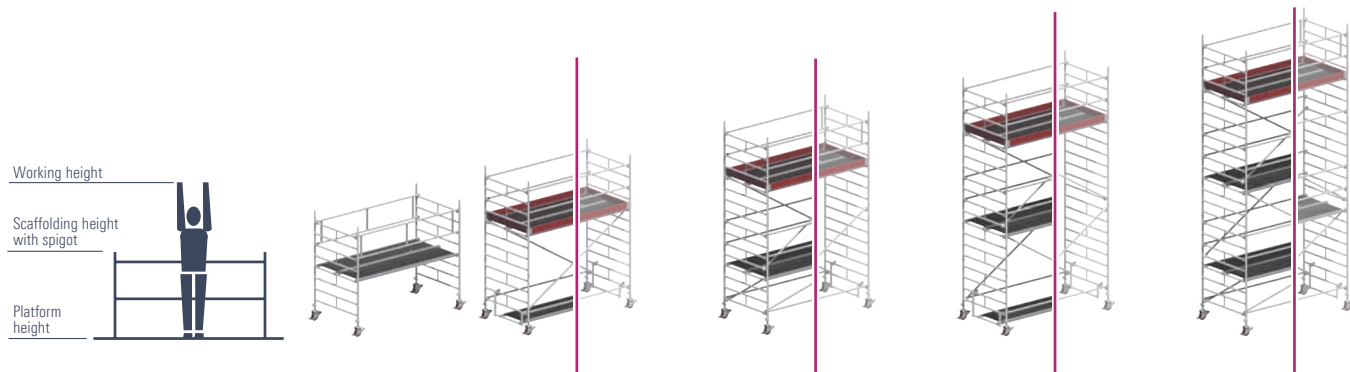
Tower model	Ref. No.	1402101	1402102	1402103	1402104	1402105	1402106	1402107	1402108	1402109	1402110	1402111
Suspended step ladder, 8 rungs	1314.108	0	1	1	2	2	3	3	4	4	5	5
Ladder support set for 1314.108	1314.109	0	1	0	0	0	1	0	1	0	1	0



### The Uni Wide family

Tower model			1402101	1402102 Min. requirements DIN EN 1004	2102 Mindestanf. DIN EN 1004	1402103 Safety structure P2	2103 Min. requirements DIN EN 1004	1402104 Safety structure P2	2104 Min. requirements DIN EN 1004	1402105 Safety structure P2	2105 Min. requirements DIN EN 1004
Working height [m]			3.20	4.20	4.20	5.20	5.20	6.20	6.20	7.20	7.20
Tower height [m]			2.43	3.43	3.43	4.43	4.43	5.43	5.43	6.43	6.43
Standing height [m]			1.20	2.20	2.20	3.20	3.20	4.20	4.20	5.20	5.20
Weight [kg] (without ballast)			111.7	187.1	162.6	240.3	177.2	278.7	198.2	331.9	276.0
<b>Ballast (stated in units)</b>											
<b>In closed areas</b>											
Assembly central*			0	0	0	0	l2 r2	l1 r1	l4 r4	l1 r1	l4 r4
Assembly off-set			X	X	X	X	X	X	X	X	X
Assembly off-set with wall bracing			X	X		X		X		X	
Assembly central with 1 bracket*			X	l0 r10	l0 r8	l0 r10	l0 r12	l0 r12	l0 r14	l0 r12	l0 r14
Assembly central with 2 brackets*			X	l3 r3	l3 r3	l2 r2	l16 r16	l5 r5	l8 r8	l4 r4	l7 r7
<b>Outdoors</b>											
Assembly central*			0	l3 r3	l3 r3	l6 r6	l6 r6	l11 r11	l11 r11	l16 r16	l16 r16
Assembly off-set			X	X	X	X	X	X	X	X	X
Assembly off-set with wall bracing			X	X	X	X	X	X	X	X	X
Assembly central with 1 bracket*			X	l0 r18	l0 r18	l0 r22	l22 r22	l6 r28	l6 r26	X	l12 r30
Assembly central with 2 brackets*			X	l14 r14	l10 r10	l16 r16	X	X	X	X	X

\* Assembly with adjustable mobile beam, which must be fully extended. X = not possible/not permissible 0 = no ballast required

For ballasting, use Layher ballast weights, Ref. No. 1249.000, 10 kg each. These weights are attached quickly and securely at the right places using the star handle coupler.

All height dimensions are calculated without any spindle travel. The maximum spindle travel of each assembly variant is listed in its assembly instruction guide!

**Do not use any liquid or granular ballast materials. The ballast weight must be distributed evenly to all ballasting fixing points (see instructions for assembly and use).**

Example:

l2, r2 → 2 ballast weights of 10 kg each must be fastened to the left-hand side of the ladder frame, and 2 ballast weights of 10 kg each to its right-hand side  
l6, r16 → 6 ballast weights of 10 kg each must be fastened to the left-hand side of the mobile beam, and 6 ballast weights of 10 kg each to its right-hand side.

r and R always relate, in the case of off-centre assembly, to that side facing away from the scaffolding; l and L relate to the side facing the scaffolding (see instructions for assembly and use).

**Retrofitting table**

Retrofitting the existing rolling tower to create the P2 design is possible using standard components of the Layher construction kit in the proven Layher quality.

Retrofit Set	Ref. No.	1400011	1400012	1400013	1400014	1400015	1400016	1400017	1400018	1400019	1400020
<i>for tower model</i>		<b>2102</b>	<b>2103</b>	<b>2104</b>	<b>2105</b>	<b>2106*</b>	<b>2107*</b>	<b>2108*</b>	<b>2109*</b>	<b>2110*</b>	<b>2111*</b>
Guardrail 2.85 m	1205.285	0	4	4	2	3	4	5	4	5	6
Diagonal brace 2.95 m	1208.295	0	2	0	2	0	2	0	2	0	2
Deck 2.85 m	1241.285	1	1	2	1	2	2	3	2	3	3
Access deck 2.85 m	1242.285	0	1	1	1	1	2	2	2	2	3
Access ledger 0.75 m	1344.003	1	0	1	0	0	0	0	0	0	0
Uni assembly hook	1300.001	1	1	1	1	1	1	1	1	1	1

\* If there is already a base strut (1324.285) and/ or double rear guardrails (1206.285) in your inventory, there's no need to replace them. They can still be used.

For compliance with the OH & S Layher recommends the safety structure P2.



1402106 Safety structure P2	2106 Min. requirements DIN EN 1004	1402107 Safety structure P2	2107 Min. requirements DIN EN 1004	1402108 Safety structure P2	2108 Min. requirements DIN EN 1004	1402109 Safety structure P2	2109 Min. requirements DIN EN 1004	1402110 Safety structure P2	2110 Min. requirements DIN EN 1004	1402111 Safety structure P2	2111 Min. requirements DIN EN 1004
8.38	8.38	9.38	9.38	10.38	10.38	11.38	11.38	12.38	12.38	13.38	13.38
7.61	7.61	8.61	8.61	9.61	9.61	10.61	10.61	11.61	11.61	12.61	12.61
6.38	6.38	7.38	7.38	8.38	8.38	9.38	9.38	10.38	10.38	11.38	11.38
454.1	377.6	514.2	406.6	545.7	420.4	605.8	498.2	637.3	512.0	697.4	541.0
0	0	0	0	0	0	0	0	0	0	0	0
0	0	0	0	0	0	0	0	0	LO R2	0	LO R2
0	0	0	0	0	0	0	0	0	0	0	0
0	0	0	0	X	0	X	X	X	X	X	X
0	L1 R1	0	L5 R5	X	X	X	X	X	X	X	X
LO R8	LO R6	LO R12	L4 R14	X	X	X	X	X	X	X	X
0	L2 R0	0	L8 R2	X	X	X	X	X	X	X	X
X	LO R6	X	X	X	X	X	X	X	X	X	X
X	X	X	X	X	X	X	X	X	X	X	X

All dimensions and weights are guideline values. Subject to technical modification. Our deliveries shall be made exclusively in accordance with our currently valid General Terms of Sale. Title to the delivered goods shall be retained until full payment has been made. When purchasing, you receive instructions for assembly and use that must be followed without fail or assembly, dismantling and use.

## Uni Wide with stabilizers



### Part list

The Layher modular system permits problem-free expansion of your rolling tower (for pictures see page 82 onwards).

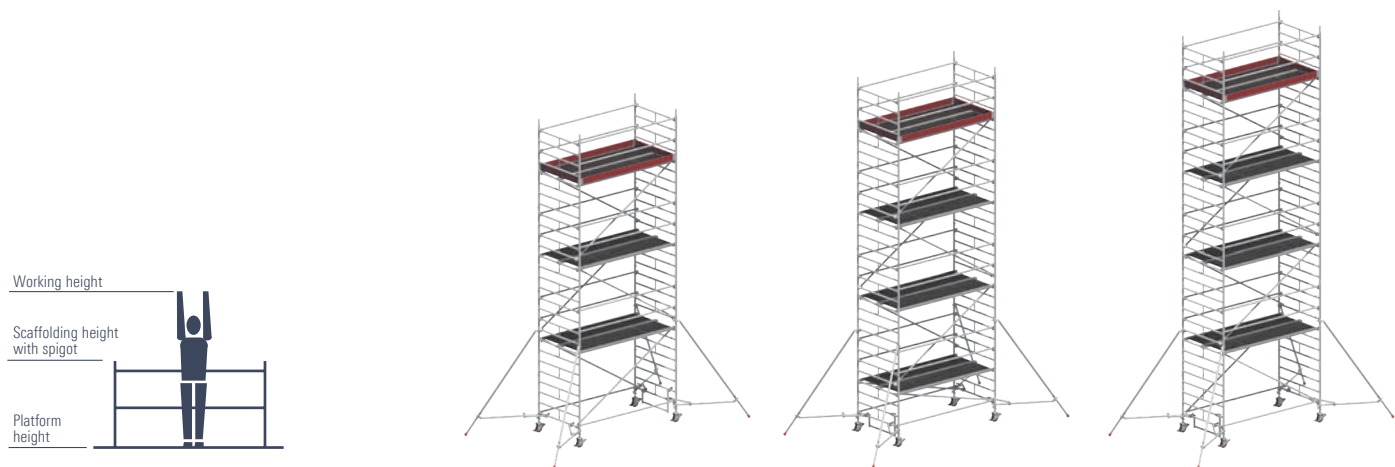
Tower model	Ref. No.	Uni Wide P2 with stabilizers, extendable					
		1402126	1402127	1402128	1402129	1402130	1402131
Guardrail 2.85 m	1205.285	14	18	18	22	22	26
Diagonal brace 3.35 m	1208.285	6	6	8	8	10	10
Diagonal brace 2.95 m	1208.295	0	2	0	2	0	2
End toe board 1.44 m	1238.144	2	2	2	2	2	2
Toe board 2.85 m with claw	1239.285	2	2	2	2	2	2
Deck 2.85 m	1241.285	3	4	4	5	5	6
Access deck 2,85 m	1242.285	3	4	4	5	5	6
Stabilizer, extendable	1248.260	4	4	4	4	4	4
Rotation preventer	1248.261	4	4	4	4	4	4
Stabilizer, 5 m	1248.500	0	0	0	0	0	0
Spring clip 11 mm	1250.000	12	12	16	16	20	20
Castor 700 – 7 kN	1259.201	4	4	4	4	4	4
Ladder frame 150 / 4 – 1.00 m	1299.004	2	0	2	0	2	0
Ladder frame 150 / 8 – 2.00 m	1299.008	6	8	8	10	10	12
Access ledger	1344.003	1	1	1	1	1	1
Uni Assembly hook	1300.001	1	1	1	1	1	1
Ballast	1249.000	For requirement see table below					



### The Uni Wide family with stabilizers, extendable

Tower model	 	1402126 Safety structure P2	1402127 Safety structure P2	1402128 Safety structure P2
Working height [m]		8.20	9.20	10.20
Tower height [m]		7.43	8.43	9.43
Standing height [m]		6.20	7.20	8.20
Weight [kg] (without ballast)		392.2	468.7	483.8
<b>Ballast</b> (stated in units)				
<b>In closed areas</b>				
Assembly central		0	0	0
Assembly off-set		LO R2	LO R2	LO R2
Assembly off-set with wall bracing		0	0	0
<b>Outdoors</b>				
Assembly central		0	0	X
Assembly off-set		LO R14	LO R18	X
Assembly off-set with wall bracing		0	0	X

X = not possible / not permissible 0 = no ballast required

For ballasting, use Layher ballast weights, Ref. No. 1249.000, 10 kg each. These weights are attached quickly and securely at the right places using the star handle coupler.

All height dimensions are calculated **without** any spindle travel. The maximum spindle travel of each assembly variant is listed in its assembly instruction guide!

**Do not use any liquid or granular ballast materials. The ballast weight must be distributed evenly to all ballasting fixing points (see instructions for assembly and use).**

Example: r2, r2 → 2 ballast weights of 10 kg each must be fastened to the left-hand side of the ladder frame, and 2 ballast weights of 10 kg each to its right-hand side  
 L6, R16 → 6 ballast weights of 10 kg each must be fastened to the left-hand side of the mobile beam, and 16 ballast weights of 10 kg each to its right-hand side.  
 r and R always relate, in the case of off-centre assembly, to that side facing away from the scaffolding; l and L relate to the side facing the scaffolding (see instructions for assembly and use).

Uni Wide P2 with stabilizers, 5 m

1402146	1402147	1402148	1402149	1402150	1402151
14	18	18	22	22	26
6	6	8	8	10	10
0	2	0	2	0	2
2	2	2	2	2	2
2	2	2	2	2	2
3	4	4	5	5	6
3	4	4	5	5	6
0	0	0	0	0	0
4	4	4	4	4	4
4	4	4	4	4	4
12	12	16	16	20	20
4	4	4	4	4	4
2	0	2	0	2	0
6	8	8	10	10	12
1	1	1	1	1	1
1	1	1	1	1	1

For requirement see table on the right

1402146 Safety structure P2	1402147 Safety structure P2	1402148 Safety structure P2	1402149 Safety structure P2	1402150 Safety structure P2	1402151 Safety structure P2
8.20	9.20	10.20	11.20	12.20	13.20
7.43	8.43	9.43	10.43	11.43	12.43
6.20	7.20	8.20	9.20	10.20	11.20
417.8	494.3	509.4	585.9	601.0	677.5
0	0	0	0	0	0
0	0	LO R2	LO R2	LO R2	LO R2
0	0	0	0	0	0
0	0	X	X	X	X
LO R10	LO R12	X	X	X	X
0	0	X	X	X	X



1402129 Safety structure P2	1402130 Safety structure P2	1402131 Safety structure P2
11.20	12.20	13.20
10.43	11.43	12.43
9.20	10.20	11.20
560.3	575.4	651.9
0	0	0
LO R2	LO R4	LO R4
0	0	0
X	X	X
X	X	X
X	X	X

All dimensions and weights are guideline values. Subject to technical modification. Our deliveries shall be made exclusively in accordance with our currently valid General Terms of Sale. Title to the delivered goods shall be retained until full payment has been made. When purchasing, you receive instructions for assembly and use that must be followed without fail or assembly, dismantling and use.

## Uni Comfort

# UNI COMFORT

THE UNIVERSAL TOWER WITH CONVENIENT STAIRWAY ACCESS



**The Uni Comfort tower is the compact tower, ideally suited to assembly and maintenance work etc.**

The convenient stairway access with full-length handrail facilitates frequent ascent and descent, easily overcomes great heights and leaves the hands free to carry tools and material.

Ladder frames (1.50 m wide) of aluminium for push-fit assembly; rear guardrails and diagonal braces of aluminium snap in easily.

Work decks with aluminium frame and plywood insert, as a hatch-type deck opening over the entire length for convenient internal access.

Sturdy castors with concentric load transmission after locking for particular stability, long steel spindles for levelling.

Outriggers for base widening can be attached without using tools; fitting them with castors permits safe movement of the tower without dismantling it.

### TECHNICAL DATA

- ▶ Working height: 14.20 m
- ▶ Area of working platform: 1.50 x 1.80 m
- ▶ Permissible live load: 2 kN / m<sup>2</sup> (scaffolding group 3)



## Uni Comfort

### Part list

The Layher modular system permits problem-free expansion of your rolling tower (for pictures see page 82 onwards).

Tower model	Ref. No.	4201	4202	4203	4204	4205	4206
Guardrail 1.80 m	1205.180	5	8	11	14	17	20
Diagonal brace 2.50 m	1208.180	1	2	3	4	5	6
Horizontal diagonal brace 2.95 m	1209.285	0	0	2	2	2	2
Landing stairway 1.80 m	1212.180	1	2	3	4	5	6
Stairway guardrail 3.07 m	1213.180	0	1	2	3	4	5
Outrigger 1.50 m	1216.000	0	0	4	4	4	4
End toe board 1.44 m	1238.144	2	2	2	2	2	2
Toe board 1.80 m with claw	1239.180	2	2	2	2	2	2
Deck 1.80 m	1241.180	2	3	4	5	6	7
Stairway access deck 1.80 m	1243.180	1	1	1	1	1	1
Spring clip	1250.000	4	8	12	16	20	24
Castor 700 – 7 kN	1259.201	4	4	8	8	8	8
Ladder frame 150/4 – 1.00 m	1299.004	2	2	2	2	2	2
Ladder frame 150/8 – 2,00 m	1299.008	2	4	6	8	10	12
Horizontal diagonal brace, adj.	1318.000	0	0	2	2	2	2
Base strut 1.80 m	1324.180	1	1	1	1	1	1
Stairway guardrail 1.20 m	1327.120	1	1	1	1	1	1
Access ledger 0.75 m	1344.003	2	2	2	2	2	2
Ballast	1249.000	For requirement see table below					

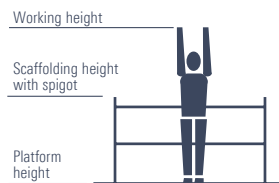

### The Uni Comfort family

Tower model	4201	4202
Working height [m]	4.20	6.20
Tower height [m]	3.43	5.43
Standing height [m]	2.20	4.20
Weight [kg] (without ballast)	166.3	236.5
<b>Ballast</b> (stated in units)		
<b>In closed areas</b>		
Without outrigger	0	6
Outriggers on both sides	△	△
Outriggers on one side	△	△
Outriggers on one side with wall bracing	△	△
<b>Outdoors</b>		
Without outrigger	2	16
Outriggers on both sides	△	△
Outriggers on one side	△	△
Outriggers on one side with wall bracing	△	△

X = not possible/not permissible 0 = no ballast required △ = Erection with additional parts, only possible after consulting the manufacturer.

For ballasting, use Layher ballast weights, Ref. No. 1249.000, 10 kg each. These weights are attached quickly and securely at the right places using the star handle coupler.

All height dimensions are calculated without any spindle travel. The maximum spindle travel of each assembly variant is listed in its assembly instruction guide!

**Do not use any liquid or granular ballast materials. The ballast weight must be distributed evenly to all ballasting fixing points (see instructions for assembly and use).**

In central assembly, the ballast weights are distributed evenly over all four ladder frame standards. The remainder not divisible by 4 must be fitted in accordance with the instructions for assembly and use.

In off-set assembly on mobile beams, the ballast weights must be distributed evenly over the two ladder frame standards away from the wall.



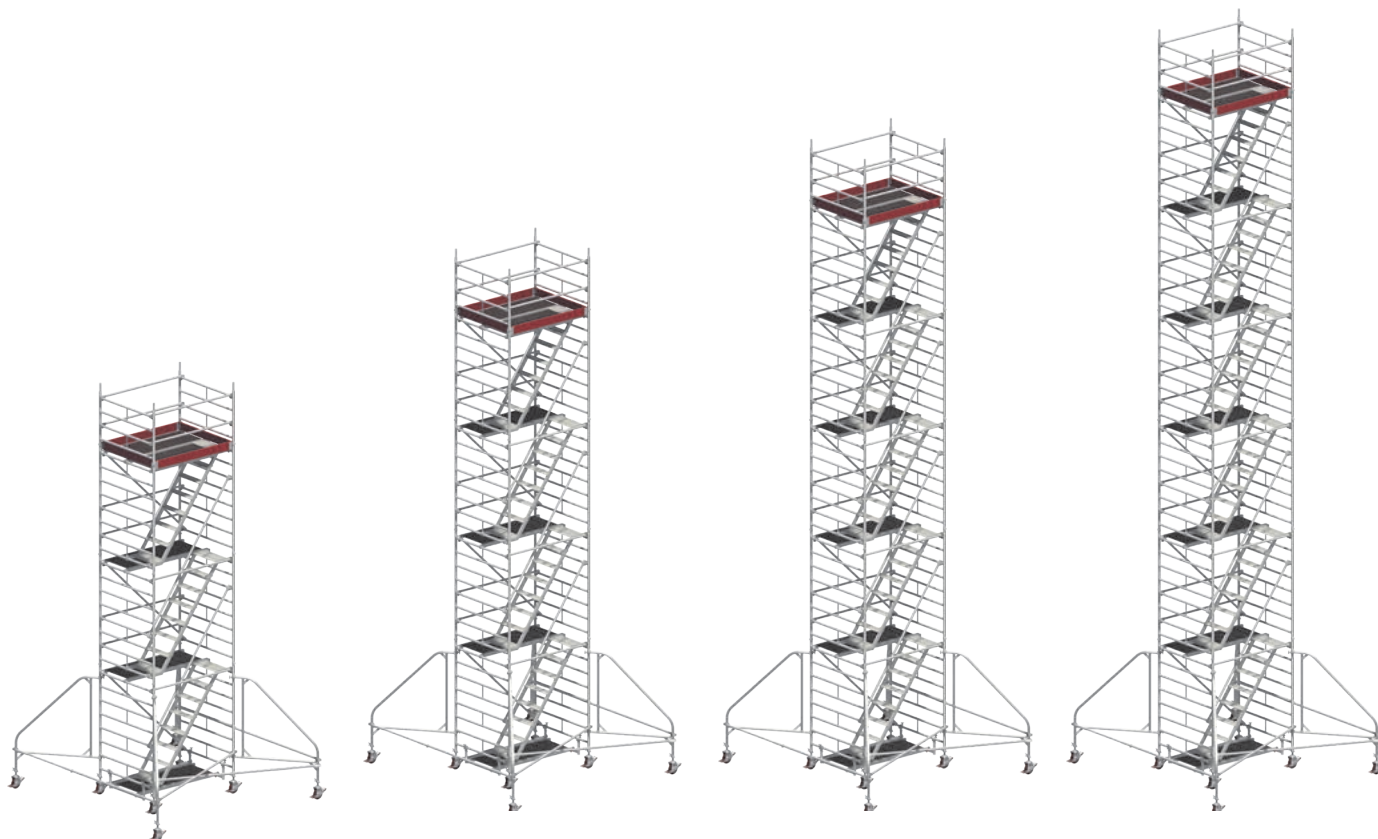

4203	4204	4205	4206
8.20	10.20	12.20	14.20
7.43	9.43	11.43	13.43
6.20	8.20	10.20	12.20
387.9	458.1	528.3	598.5
X	X	X	X
0	0	0	0
2	4	6	8
0	0	0	0
X	X	X	X
0	0	X	X
20	X	X	X
0	4	X	X

All dimensions and weights are guideline values. Subject to technical modification. Our deliveries shall be made exclusively in accordance with our currently valid General Terms of Sale. Title to the delivered goods shall be retained until full payment has been made. When purchasing, you receive instructions for assembly and use that must be followed without fail or assembly, dismantling and use.

## Staro rolling tower

# STARO ROLLING TOWER

THE READY-MADE TOWER FOR FREEDOM OF MOVEMENT AND A LARGE WORKING AREA





The Staro rolling tower is the "ready-made" tower with a large work surface. It is indispensable for fast work on large ceiling surfaces or for assembling components or installation work underneath the ceiling. The large work surface offers ample freedom of movement and space for storing tools and materials ready to hand.



Basic assembly in aluminium; rear guardrails are easily snapped in.

Work decks with aluminium frame and plywood insert.

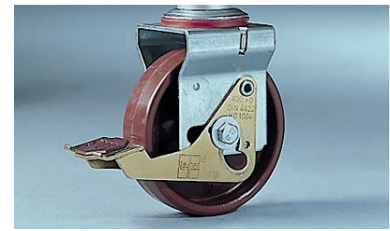

Sturdy castors (dia. 150 mm) with concentric load transmission after locking, for particular stability. Leg tube (1.95 m long) with holes 11 cm apart for height adjustment.



Type 7000



Type 7001

Includes the additional equipment for use at platform height from 1 m.

TECHNICAL DATA

- ▶ Working height: 3.90 m
- ▶ Area of working platform: 1.95 x 1.95 m
- ▶ Permissible live load: 1.5 kN / m<sup>2</sup> (scaffolding group 2)

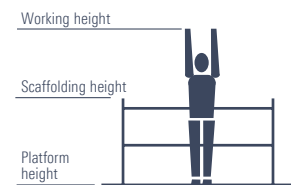

Part list

Tower model	Ref. No.	7000	7001
Staro basic tower, incl. 4 clips	1224.000	1	1
Staro guardrail 1.90 m	1227.190	2	4
Staro deck 1.90 m	1241.190	3	3
Leg tube with castor	1302.150	4	4
Ladder for Staro rolling tower	1246.006	0	1
Intermediate guardrail 1.90 m	1224.190	0	2
End toe board 1.90 m	1238.190	0	2
Toe board 1.95 m	1239.195	0	2

Tower model	7000	7001
Working height [m]	2.80 – 3.90*	2.80 – 3.90
Tower height [m]	1.89 – 2.78*	1.89 – 2.78
Standing height [m]	0.80 – 1.90*	0.80 – 1.90
Weight [kg]	99.9	132.5

\* from platform height of 1 m, the additional equipment is required.

Additional equipment:

Above 1 m platform height, intermediate guardrails 1.90 m (2 x 1224.190), Staro rear guardrail (2 x 1227.190) and toe boards (2 x 1238.190, 2 x 1239.195) must be used for appropriate work. The tower may only be accessed using the access ladder.

## Alu bridging beam

# ALU BRIDGING BEAM

THE WORKING DECK UP TO 10 M LONG



### TECHNICAL DATA

- ▶ Conforms to DIN EN 12811-1
- ▶ Permissible load class 2 (1.5 kN/m<sup>2</sup> bis 10 m length)
- ▶ Permissible load class 3 (2 kN/m<sup>2</sup> bis 7.10 m length)

The Alu bridging beam 600 is a quick and handy component. Lightweight, as it's made of aluminium, and stable, as it's made from special sections. It is possible to attach, depending on the application, a three-piece side protection to the Alu bridging beam.

**Alu bridging beam 600**

Length [m]	Load [kN/m <sup>2</sup> ]	Width [m]	Height [m]	Weight [kg]	Ref. No.
3.18	2.0	0.60	0.09	20.0	<b>1348.318</b>
4.12	2.0	0.60	0.09	26.0	<b>1348.412</b>
4.75	2.0	0.60	0.09	29.0	<b>1348.475</b>
5.20	2.0	0.60	0.12	38.0	<b>1348.520</b>
6.15	2.0	0.60	0.12	45.0	<b>1348.615</b>
7.10	2.0	0.60	0.12	52.0	<b>1348.710</b>
8.00	1.5	0.60	0.15	68.0	<b>1348.800</b>
9.10	1.5	0.60	0.15	76.0	<b>1348.910</b>
10.00	1.5	0.60	0.15	85.0	<b>1348.100</b>



**1331.000 clamp**  
see page 90.

The Alu bridging beam 600, folding, can also be used in load class 2. A folding device allows it to be folded up into handy transport dimensions.

**Alu bridging beam 600, folding**

Length [m]	Load [kN/m <sup>2</sup> ]	Width [m]	Height [m]	Weight [kg]	Ref. No.
5.10	1.5	0.60	0.12	47.0	<b>1349.510</b>
7.30	1.5	0.60	0.12	61.0	<b>1349.730</b>
9.15	1.5	0.60	0.15	86.0	<b>1349.915</b>



☞ Only available ex works.

**Side protection for Alu bridging beam 600**

KIT-No.	Ref. No.	6201	6202	6203	6204	6205	6206	6207	6208	6209
		3.18 m	4.12 m	4.75 m	5.20 m	6.15 m	7.10 m	8.00 m	9.10 m	10.00 m
Double guardrail 2.00 m	1332.200	0	2	1	1	0	2	1	0	2
Double guardrail 3.00 m	1332.300	1	0	1	1	2	1	2	3	2
Guardrail fixture	1330.000	2	4	4	4	4	6	6	6	8
Guardrail locking clip	1333.000	1	2	2	2	2	3	3	3	4



**1330.000**

**Side protection for Alu bridging beam 600, folding**

KIT-No.	Ref. No.	6210	6211	6212
		5.10 m	7.30 m	9.15 m
Double guardrail 2.00 m	1332.200	2	0	4
Double guardrail 3.00 m	1332.300	0	2	0
Guardrail fixture	1330.000	4	4	8
Guardrail locking clip	1333.000	2	2	4



**1333.000**

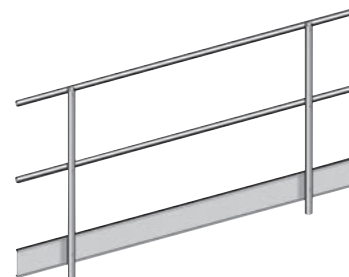

**1332.200/1332.300**

**Alu telescopic stage 1351**

The Alu telescopic stage offers a wide and variable range of possible applications. For transport, the telescopic stage can be simply pushed together, resulting in low transport dimensions. Since the Alu telescopic stage is extendable, it can be pulled out or pushed together to provide any required length.

Loading capacity: **150 kg**

Length [m]	Width [m]	Height [m]	Weight approx. [kg]	Ref. No.
1.64 – 2.90	0.31	0.08	13.0	<b>1351.290</b>
1.92 – 3.50	0.31	0.08	16.0	<b>1351.350</b>
2.27 – 4.00	0.31	0.08	18.0	<b>1351.400</b>
2.49 – 4.40	0.31	0.08	20.0	<b>1351.440</b>

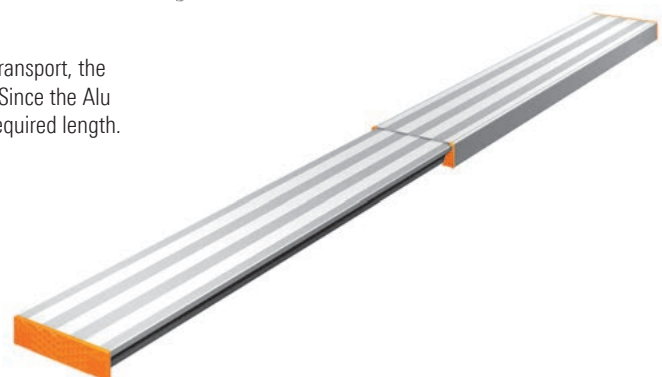

## Bracket deck surfaces

# BRACKET DECK SURFACES

## WORKING SERVICE WIDENING FOR UNI STANDARD AND UNI WIDE



**Special designs are individualized tower structures that make work safer and faster at many construction sites.**

The examples on this page show the widening of the top scaffolding level and the formation of several working levels using console brackets.

For these tower forms, we have acquired the GS safety inspection certificate that is sufficient for the use of the tower and eliminates the need for structural strength verification otherwise required.

### TECHNICAL DATA

- ▶ Subsequent attachment to completed towers is possible
- ▶ Rapid and easy widening of the working surface of up to 1.50 m
- ▶ Permissible live load: 1.5 kN / m<sup>2</sup> (scaffolding group 2)

### Extension-KITS for attachment of 1 or 2 bracket deck surfaces for Uni Standard and Uni Wide

KIT-No.	Ref. No.	9100 1 bracket deck surface	9200 1 bracket deck surfaces
End toe board 0.75 m	1238.075	2	4
Deck 2.85 m	1241.285	1	2
Spring clip	1250.000	4	8
Ladder frame 75/4 – 1.00 m	1297.004	2	4
Intermediate deck	1339.285	1	2
Alu console bracket 0.75 m	1341.075	2	4

The number of ballast weights required is stated in the appropriate instructions for assembly and use.

All dimensions and weights are guideline values. Subject to technical modification. Our deliveries shall be made exclusively in accordance with our currently valid General Terms of Sale. Title to the delivered goods shall be retained until full payment has been made. When purchasing, you receive instructions for assembly and use that must be followed without fail or assembly, dismantling and use.

# UNI LIFT 200

## A HELPFUL ACCESSORY FOR ROLLING TOWERS

For more convenient yet safer vertical transport of materials at rolling towers, Layher has designed the Uni Lift 200. Specially developed components, fitted with the proven Layher snap-on claw, permit quick connection of the Uni Lift 200 to a Layher rolling tower without using tools.

The Uni Lift 200 represents a separately movable and usable unit in triangular form, allowing it to be used flexibly at construction sites together with Layher's Uni Standard and Uni Wide rolling towers.

The load platform permits reliable and convenient vertical transport of bulky board materials, paint buckets or large tools, for example. That in turn ensures safer ascent and descent of the rolling tower with both hands free. All four sides of the load platform can be folded down or removed as required. Various fastening points for the material enable it to be safely transported to the top scaffolding level, where it can be removed horizontally. The sturdy mobile trestle is used for tool-free mounting of the bottom lift section. Wheels enable the solid frame to be moved safely on a flat surface.

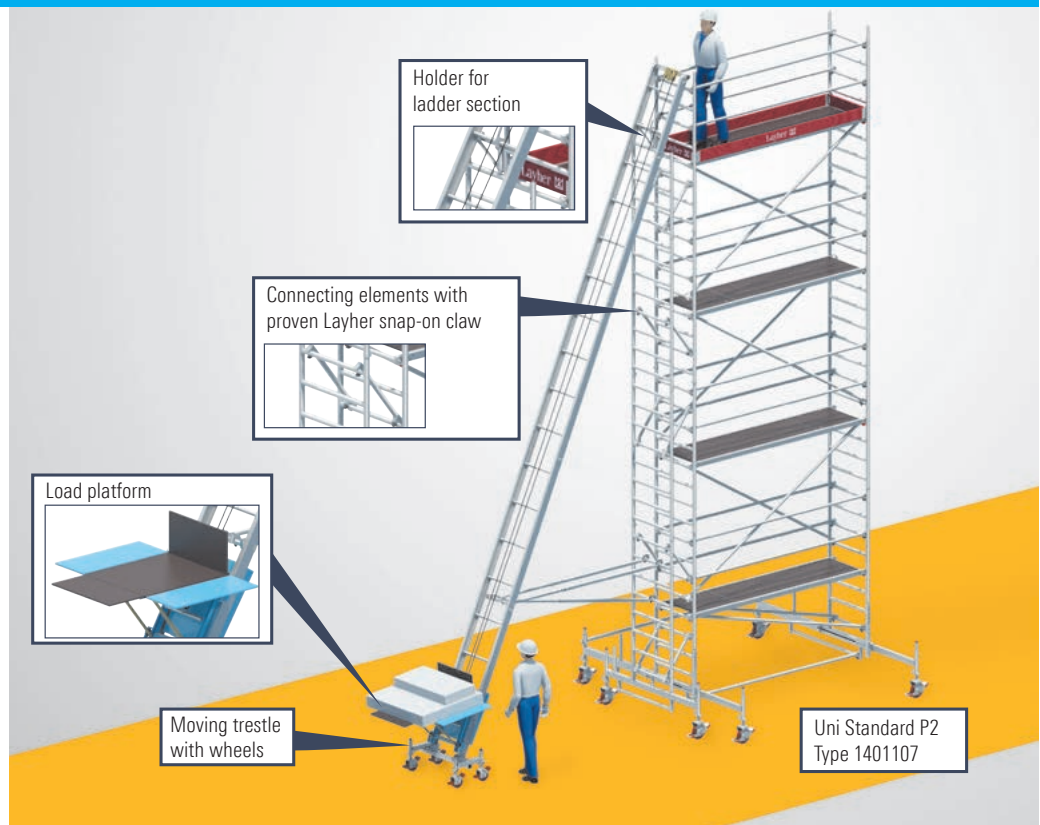

### TECHNICAL DATA

- ▶ Rolling tower with platform height: 7.00 m
- ▶ Efficient, very safe and tool-free assembly.
- ▶ Perm. load: up to 200 kg

### Uni Lift 200

Description	Weight approx. [kg]	Ref. No.
<b>Uni Lift 200</b> For rolling tower with a 7 m platform height (1401107, 1402107 etc.)	293	<b>1601.007</b>

### YOUR BENEFITS AT A GLANCE

- ▶ Separately movable and usable unit for flexible and rapid connection to Layher's Uni Standard and Uni Wide rolling towers.
- ▶ Safer and more convenient vertical transport using the load platform ensures both hands are free for ascent and descent of the rolling tower.
- ▶ Horizontal loading and unloading of the load platform with fold-down sides without an awkward loading edge, for ergonomic and safe handling of heavy and/or bulky materials.
- ▶ Efficient and safe assembly without using tools.
- ▶ Load capacity of up to 200 kg permits vertical transport of heavy loads.

The number of ballast weights required is stated in the appropriate instructions for assembly and use.

All dimensions and weights are guideline values. Subject to technical modification. Our deliveries shall be made exclusively in accordance with our currently valid General Terms of Sale. Title to the delivered goods shall be retained until full payment has been made. Please request the specific instructions for assembly and use when ordering.

## Basic knowledge about castors

# CASTORS FROM LAYHER

Ref. No.	Description	Castor type	Illustration	Wheel	Wheel diameter [mm]	Bearing type (wheel hub)
1259.201	Castor 700	Height adjustable castor		Polyamide wheel	200	Plain bearing (steel sleeve in plastic hub)
1259.202	Polyurethane Castor 700	Height-adjustable castor		Polyamide wheel with polyurethane tire	200	Plain bearing (steel sleeve in plastic hub)
1260.201	Castor 1000	Height-adjustable castor		Polyamide wheel	200	Plain bearing (steel sleeve in plastic hub)
1260.202	Castor 1000 with electro-conductive polyurethane coating	Height-adjustable castor		Polyamide wheel with polyurethane tire	200	Sealed ball bearing
1267.200	Castor 1200 with half-coupler	Height-adjustable castor		Polyamide wheel	200	Plain bearing (steel sleeve in plastic hub)
1308.150	Castor 400	Castor with tube connector		Polyamide wheel	150	Plain bearing (steel sleeve in plastic hub)
1309.150	Polyurethane Castor 400	Castor with tube connector		Polyamide wheel with polyurethane tire	150	Plain bearing (steel sleeve in plastic hub)
1300.150	Castor 400 with spindle 250	Height-adjustable castor		Polyamide wheel	150	Plain bearing (steel sleeve in plastic hub)



	Max. perm. load [kg] – braked	Max. dyn. load [kg] – unbraked – at 4 km/h and over a distance of 2500 m without obstacles	Temperature resistance	Application
	700	350	–40 °C to +90 °C	All firm ground! E.g.: Concrete / screed / cobbles / wooden boards / asphalt
	700	350	–20 °C to +50 °C	Firm ground with sensitive surface! E.g.: Tiles / natural stone / parquet / laminate <b>Careful with sprung floors such as floors of sports halls, the max. load of the floor applies here, otherwise provision of a load-distributing base (plywood boards) is essential!</b>
	1000	1000	–40 °C to +90 °C	All firm ground! E.g.: Concrete / screed / cobbles / wooden boards / asphalt
	1000	800	–25 °C to +70 °C, short-term to +90 °C	Firm ground with sensitive surface! E.g.: Tiles / natural stone / parquet / laminate <b>Useable in explosive or EISD areas, thanks to the bleeder resistance &lt;math&gt;&lt; 10^4 \Omega&lt;/math&gt;. Careful with sprung floors such as floors of sports halls, the max. load of the floor applies here, otherwise provision of a load-distributing base (plywood boards) is essential!</b>
	1200	960	–40 °C to +90 °C	All firm ground! E.g.: Concrete / screed / cobbles / wooden boards / asphalt
	400	200	–40 °C to +90 °C	All firm ground! E.g.: Concrete / screed / cobbles / wooden boards / asphalt
	400	200	–20 °C to +50 °C	Firm ground with sensitive surface! E.g.: Tiles / natural stone / parquet / laminate <b>Careful with sprung floors such as floors of sports halls, the max. load of the floor applies here, otherwise provision of a load-distributing base (plywood boards) is essential!</b>
	400	400	–20 °C to +50 °C	All firm ground! E.g.: Concrete / screed / cobbles / wooden boards / asphalt

# Components

PA01022416 Steigtechnik EN.pdf

PA01022416 Steigtechnik EN.pdf

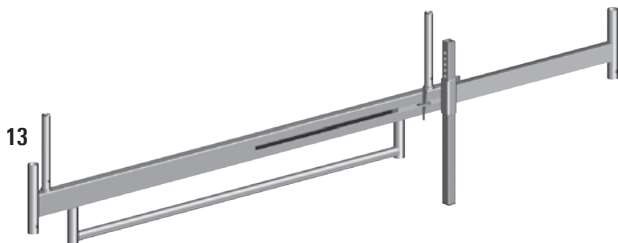
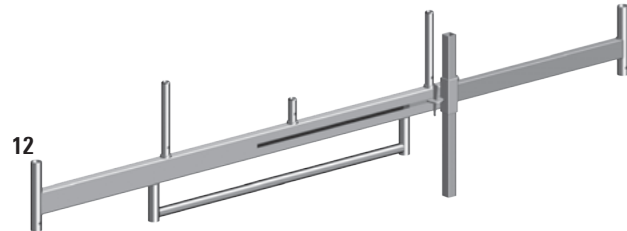
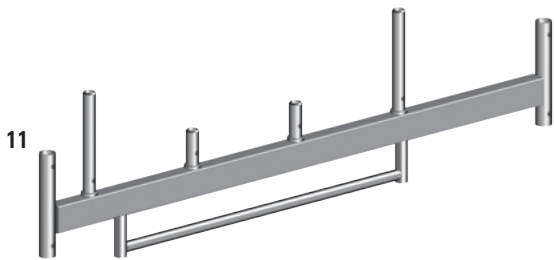
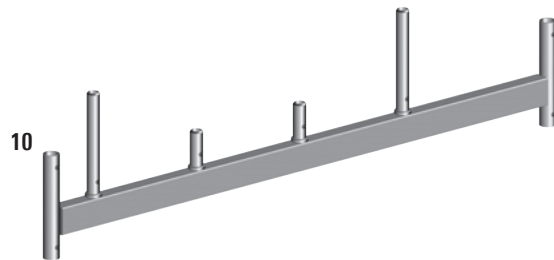
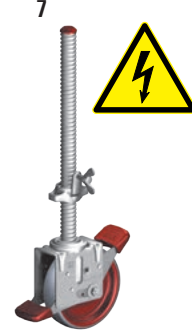

Pos.	Description	Dimensions [m]	Weight approx. [kg]	Ref. No.	Zifa	Uni Light	Uni Compact	Uni Standard	Uni Wide	Uni Comfort	Stano
1	<b>Castor 400</b> Plastic wheel dia. 150 mm, with simple brake lever. Permissible load: 4 kN (≈ 400 kg).	Ø 0.15	2.1	1308.150	▶	▶					
2	<b>Castor 400, with polyurethane tyre</b> Plastic wheel with polyurethane tyre, dia. 150 mm. Special wheel for sensitive floor surfaces. Permissible load: 4 kN (≈ 400 kg).	Ø 0.15	2.4	1309.150	📦	▶	▶				
3	<b>Castor 400 with spindle 250</b> Plastic wheel, dia. 150 mm, with base jack, adjustment range 0 – 0.20 m, castor with double brake lever and load centering in the braked state. Permissible load: 4 kN (≈ 400 kg).	Ø 0.15	2.1	1300.150	▶	▶					
4	<b>Castor 700</b> Plastic wheel, dia. 200 mm. With base jack, adjustment range 0.30–0.60 m, spindle nut with lock, castor with double brake lever and load centering in the braked state. Permissible load: 7.0 kN (≈ 700 kg).	Ø 0.20	6.8	1259.201	▶	▶	▶	▶	▶	▶	
5	<b>Castor 700, with polyurethane tyre</b> Plastic wheel, dia. 200 mm. With base jack, adjustment range 0.30–0.60 m, spindle nut with lock, castor with double brake lever and load centering in the braked state. Permissible load: 7.0 kN.	Ø 0.20	7.0	1259.202	📦	▶	▶	▶	▶	▶	▶
6	<b>Castor 1000</b> Plastic wheel, dia. 200 mm of polyamide. With base jack, adjustment range 0.30–0.60 m, spindle nut with lock, castor with double brake lever and load centering in the braked state. Permissible load: 10 kN.	Ø 0.20	6.3	1260.201	▶	▶	▶	▶	▶	▶	
7	<b>Castor 1000, with electroconductive polyurethane coating</b> Plastic wheel, dia. 200 mm of polyamide with coating of electroconductive polyurethane. With base jack, adjustment range 0.30–0.60 m, spindle nut with lock, castor with double brake lever and load centering in the braked state. Permissible load: 10 kN Special castor for sensitive floorings and thanks to electro-conductability also usable in explosive or ESD areas. Bleeder resistance according to DIN EN 12526 < 10 <sup>4</sup> Ω.	Ø 0.20	6.8	1260.202	📦	▶	▶	▶	▶	▶	▶
8	<b>Castor 1200, with half-coupler</b> reinforced plastic wheel, dia. 200 mm, with base jack, adjustment range 0.30–0.60 m, spindle nut with lock. Permissible load: 12 kN.	Ø 0.20	12.0	1267.200	📦	▶	▶	▶	▶	▶	▶
9	<b>Adjustable base plate 60 with lock</b> steel, hot-dip galvanized, with nut, base plate 150 x 150 mm, max. spindle travel 0.40 m.	0.60	3.8	1257.060	▶	▶	▶	▶	▶	▶	
10	<b>Mobile beam</b> Steel rectangular tube, hot-dip-galvanized. For widening the base of towers.	1.80	14.4	1214.180	▶	▶					
11	<b>Mobile beam with bar</b> Steel rectangular tube, hot-dip-galvanized. For widening the base of towers.	1.80	16.9	1323.180	▶	▶		▶			
12	<b>Mobile beam with bar, adjustable</b> Steel rectangular tube, hot-dip-galvanized. System component for base widening.	2.30 – 3.20	42.5	1323.320				▶	▶	▶	
13	<b>Mobile beam with 2 spigots, adjustable</b> Steel rectangular tube, hot-dip-galvanized. For widening the base for special mobile assemblies. System assemblies only possible in conjunction with Ref. No. 1337.000 (see page 85).	2.30 – 3.20	42.6	1338.320	▶	▶	▶	▶	▶		

WS = wrench size PU = packaging unit 📦 = available ex works 🕒 = delivery time on request 📦 = only available in this packaging unit ▶ = included in tower kit ▶ = optional accessory for tower model

# Components

PA01022416 Steigtechnik EN.pdf

PA01022416 Steigtechnik EN.pdf

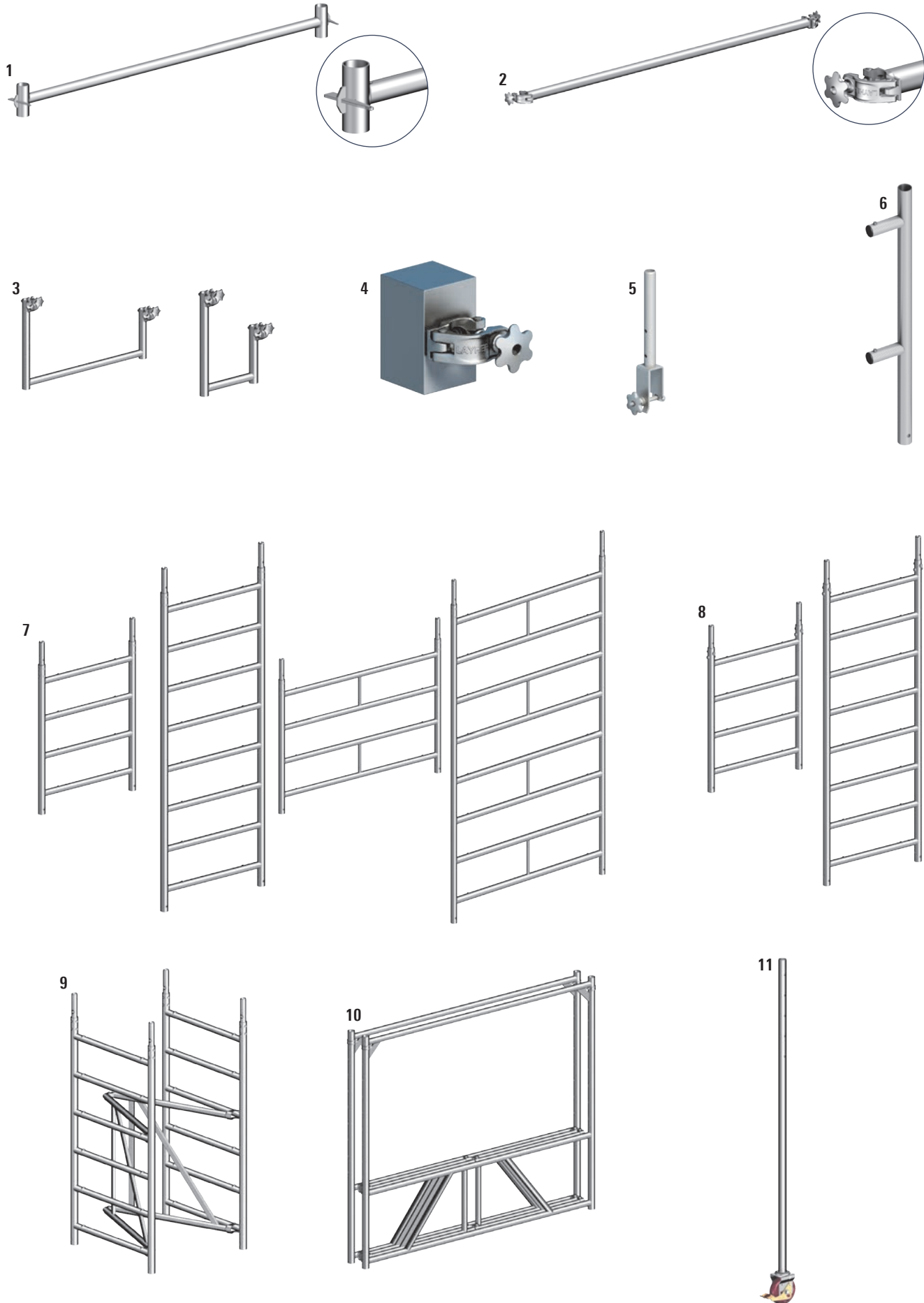

Pos.	Description	Dimensions L/H x W [m]	Weight approx. [kg]	Ref. No.	Zifa	Uni Light	Uni Compact	Uni Standard	Uni Wide	Uni Comfort	Staro
1	<b>Basic tube</b> steel tube, hot-dip galvanized.	1.80	7.7	<b>1211.180</b>	▶	▶	▶				
		2.85	12.2	<b>1211.285</b>				▶	▶		
2	<b>Base strut</b> with 2 half-couplers, steel tube, hot-dip galvanized.	1.80	6.2	<b>1324.180</b>	▶	▶	▶				
		2.85	9.3	<b>1324.285</b>				▶	▶	▶	
3	<b>Access ledger</b> aluminium.	0.30	2.9	<b>1344.002</b>	▶	▶		▶			
		0.75	3.3	<b>1344.003</b>			▶		▶		
4	<b>Ballast (10 kg)</b> steel, hot-dip galvanized with half-coupler. For ballasting of towers refer to the instructions for assembly and use of mobile work platforms.		10.0	<b>1249.000</b>	▶	▶	▶	▶	▶	▶	
5	<b>Spigot, adjustable</b> steel, hot-dip galvanized. System assemblies only possible in conjunction with Ref. No. 1338.320 (see page 83).		2.1	<b>1337.000</b>	▶	▶	▶	▶	▶		
6	<b>Guardrail support</b>	1.00	1.3	<b>1297.100</b>	▶	▶	▶	▶	▶	▶	
7	<b>Ladder frame</b> aluminium. Rungs with non-slip grooving.	1.00 x 0.75	4.7	<b>1297.004</b>	▶	▶		▶			
		2.00 x 0.75	8.6	<b>1297.008</b>	▶	▶		▶			
		1.00 x 1.50	7.0	<b>1299.004</b>				▶		▶	▶
		2.00 x 1.50	13.5	<b>1299.008</b>				▶		▶	▶
8	<b>Suspension ladder 75</b> aluminium. Rungs with non-slip grooving.  Spigot bolted using 4 bolts M12 x 60 with nuts.	1.00 x 0.75	6.3	<b>1298.004</b>	▶	▶		▶			
		2.00 x 0.75	10.3	<b>1298.008</b>	▶	▶		▶			
9	<b>Zifa 75 basic tower</b> aluminium. Dimensions when folded together: 0.95 x 1.50 x 0.30 m.	1.80 x 1.50 x 0.75	20.2	<b>1300.006</b>	▶						
10	<b>Staro basic tower</b> aluminium. Including 4 clips. Dimensions when folded together: 2.00 x 1.60 x 0.25 m.	2.00 x 1.60 x 2.00	28.8	<b>1224.000</b>							▶
11	<b>Leg tube with castor 400</b> dia. 150 mm. With simple brake lever and load centering in the braked state. Wheel and slewing ring can be locked. Steel, plastic wheel.	1.95	6.6	<b>1302.150</b>							▶

WS = wrench size PU = packaging unit 📦 = available ex works 🕒 = delivery time on request 📦 = only available in this packaging unit ▶ = included in tower kit ▶ = optional accessory for tower model

# Components

PA01022416 Steigtechnik EN.pdf

PA01022416 Steigtechnik EN.pdf

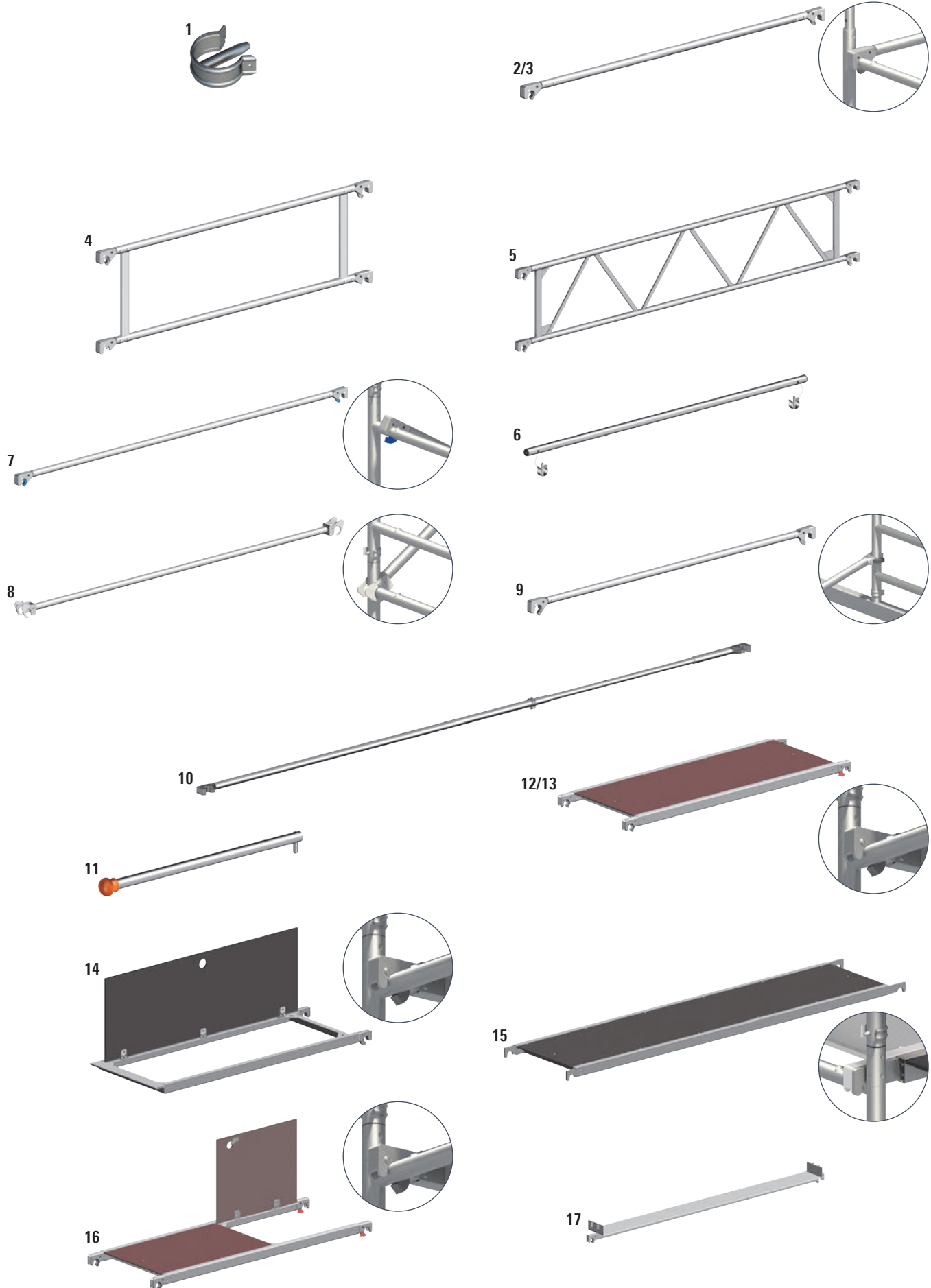

Pos.	Description	Dimensions L/H x W [m]	Weight approx. [kg]	Ref. No.	Zita	Uni Light	Uni Compact	Uni Standard	Uni Wide	Uni Comfort	Staro
1	<b>Spring clip</b> , steel.		0.1	<b>1250.000</b>	▶	▶	▶	▶	▶	▶	▶
2	<b>Guardrail</b> , aluminium.	1.80	2.3	<b>1205.180</b>	▶	▶	▶			▶	
		2.85	3.6	<b>1205.285</b>				▶	▶		
3	<b>Staro guardrail</b> , aluminium.	1.90	2.7	<b>1227.190</b>							▶
4	<b>Double guardrail</b> , aluminium.	1.80 x 0.50	5.8	<b>1206.180</b>	▶	▶	▶				
		2.85 x 0.50	8.0	<b>1206.285</b>				▶	▶		
5	<b>Beam</b> , aluminium for use as support beam in the modular system or as double guardrail.	1.80 x 0.50	7.7	<b>1207.180</b>	📦	▶	▶	▶			▶
		2.85 x 0.50	9.6	<b>1207.285</b>					▶	▶	
6	<b>Intermediate guardrail</b> aluminium.	1.90	1.9	<b>1224.190</b>							▶
7	<b>Diagonal brace</b> aluminium.	1.95	2.8	<b>1208.195</b>	▶	▶	▶				
		2.50	3.3	<b>1208.180</b>	▶	▶	▶				▶
		2.95	3.8	<b>1208.295</b>				▶	▶		
		3.35	4.1	<b>1208.285</b>				▶	▶		
8	<b>Deck diagonal brace</b> aluminium.	2.50	4.2	<b>1347.250</b>	📦	▶	▶	▶			▶
		3.35	5.0	<b>1347.335</b>					▶	▶	
9	<b>Horizontal diagonal brace</b> aluminium.	1.95	3.5	<b>1209.180</b>	▶	▶					
		2.95	4.6	<b>1209.285</b>				▶		▶	
10	<b>Horizontal diagonal brace, adjustable</b> aluminium.	3.20 – 4.00	6.1	<b>1318.000</b>					▶	▶	
11	<b>Uni distance tube</b> , aluminium tube, with hook and rubber foot.	1.10	1.4	<b>1275.110</b>	📦	▶	▶	▶			
		1.80	2.1	<b>1275.180</b>	📦			▶		▶	▶
12	<b>Deck</b> aluminium frame, with plywood deck and hatch with phenolic resin coating.	1.80 x 0.68	13.3	<b>1241.180</b>	▶	▶	▶				▶
		2.85 x 0.68	20.0	<b>1241.285</b>				▶	▶		
13	<b>Staro deck</b> aluminium frame, with plywood deck and hatch with phenolic resin coating.	1.90 x 0.60	13.1	<b>1241.190</b>							▶
14	<b>Stairway access deck</b> aluminium frame, with plywood deck and hatch with phenolic resin coating.	1.80 x 0.68	12.2	<b>1243.180</b>							▶
15	<b>Bridging deck</b> for twin towers. Aluminium frame, with plywood deck with phenolic resin coating.	2.85 x 0.66	19.8	<b>1343.285</b>	🕒				▶		
16	<b>Access deck</b> aluminium frame, with plywood deck and hatch with phenolic resin coating.	1.80 x 0.68	15.0	<b>1242.180</b>	▶	▶	▶				
		2.85 x 0.68	21.6	<b>1242.285</b>				▶	▶		
17	<b>Intermediate deck</b> , aluminium for console bracket structures.	2.85 x 0.23	10.5	<b>1339.285</b>	📦				▶	▶	

WS = wrench size PU = packaging unit 📦 = available ex works 🕒 = delivery time on request 📦 = only available in this packaging unit ▶ = included in tower kit ▶ = optional accessory for tower model

# Components

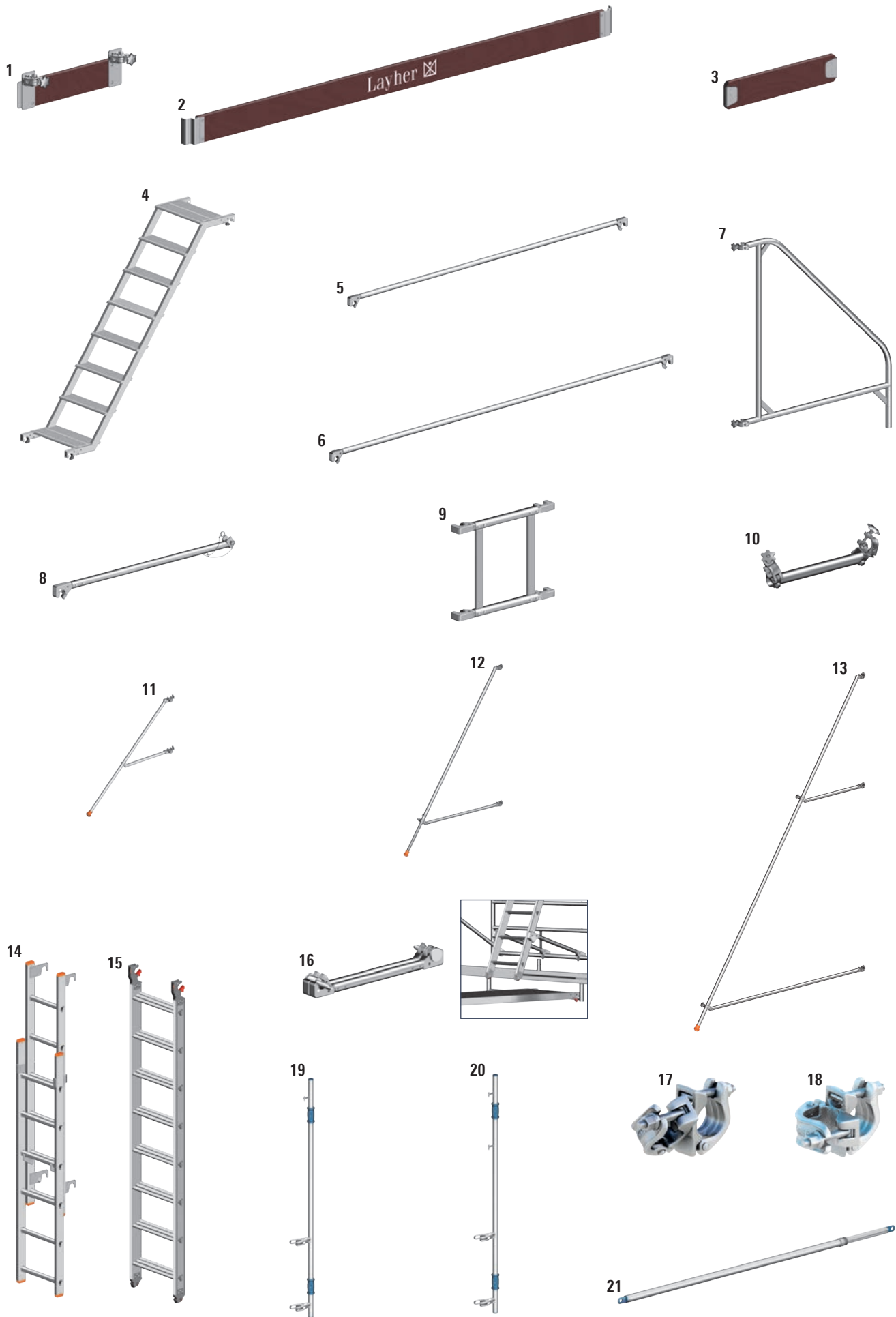



Pos.	Description	Dimensions L/H x W [m]	Weight approx. [kg]	Ref. No.								
					Zifa	Uni Light	Uni Compact	Uni Standard	Uni Wide	Uni Comfort	Staro	
1	<b>Toe board</b> , wood for twin towers. For bridging deck.	0.60 x 0.15	3.5	1340.060	⊕				▶			
2	<b>Toe board with claw</b> , wood	1.80 x 0.15	3.9	1239.180		▶	▶	▶				
		1.95 x 0.15	3.9	1239.195								▶
		2.85 x 0.15	6.5	1239.285					▶	▶		
3	<b>End toe board</b> , wood	0.75 x 0.15	1.3	1238.075		▶	▶		▶			
		1.44 x 0.15	3.2	1238.144				▶		▶	▶	
		1.90 x 0.15	3.9	1238.190								▶
4	<b>Landing stairway</b> , aluminium		15.5	1212.180							▶	
5	<b>Stairway guardrail</b> , aluminium for use for landing-type stairway Ref. No. 1212.180	3.07	3.8	1213.180							▶	
6	<b>Strut for outrigger</b> , aluminium locks the outrigger Ref. No. 1216.000	3.75	5.4	1217.375	📦						▶	
7	<b>Outrigger</b> , aluminium for widening the bases of higher structures. Locking with horizontal diagonal brace Ref. No. 1209.285	1.50	8.2	1216.000							▶	
8	<b>Stairway guardrail</b> , aluminium	1.20	1.8	1327.120	📦						▶	
9	<b>Guardrail</b> , aluminium for twin towers and bridging	0.58 x 0.50	4.7	1342.058	⊕				▶			
10	<b>Rotation preventer</b> , aluminium	0.5	2.8	1248.261		▶	▶	▶	▶	▶		
11	<b>Stabilizer</b> , aluminium	1.80	5.2	1248.180	⊕	▶	▶	▶	▶	▶		
12	<b>Stabilizer, extendable</b> , aluminium	2.60 – 3.40	8.5	1248.260		▶	▶	▶	▶	▶		
13	<b>Stabilizer</b> , aluminium	5.00	14.9	1248.500					▶	▶		
14	<b>Ladder for Staro rolling tower</b> , aluminium. 6 double rungs		7.8	1246.006							▶	
15	<b>Suspended step ladder</b> , aluminium 8 steps, with snap-on hook and castors at the ladder base	2.20	6.8	1314.108	📦				▶	▶		
16	<b>Ladder support set</b> for suspended ladder Ref. No. 1314.108		2.0	1314.109	📦				▶	▶		
17	<b>Swivel coupler</b> steel, galvanized	WS 19	1.4	4702.019		▶	▶	▶	▶	▶	▶	
		WS 22	1.4	4702.022		▶	▶	▶	▶	▶	▶	
18	<b>Double coupler</b> steel, galvanized.	WS 19	1.3	4700.019		▶	▶	▶	▶	▶	▶	
		WS 22	1.3	4700.022		▶	▶	▶	▶	▶	▶	
19	<b>Advance guardrail post</b> , aluminium for one advance guardrail (1.00 m height); rapid attachment of the guardrails with tilting pins	2.26	4.2	4031.001	📦	▶	▶	▶	▶	▶		
20	<b>Advance guardrail post</b> , aluminium for two advance guardrails (0.50 m and 1.00 m height); rapid attachment of the guardrails with tilting pins	2.26	4.3	4031.002	📦	▶	▶	▶	▶	▶		
21	<b>Advance guardrail</b> , 1.57/2.07 m <b>Advance guardrail</b> , 2.57/3.07 m aluminium	1.65	3.2	4031.207	📦	▶	▶	▶				
		2.15	4.0	4031.307	📦				▶	▶		

WS = wrench size PU = packaging unit 📦 = available ex works ⊕ = delivery time on request 📦 = only available in this packaging unit ▶ = included in tower kit ▶ = optional accessory for tower model

# Components



# Spare parts

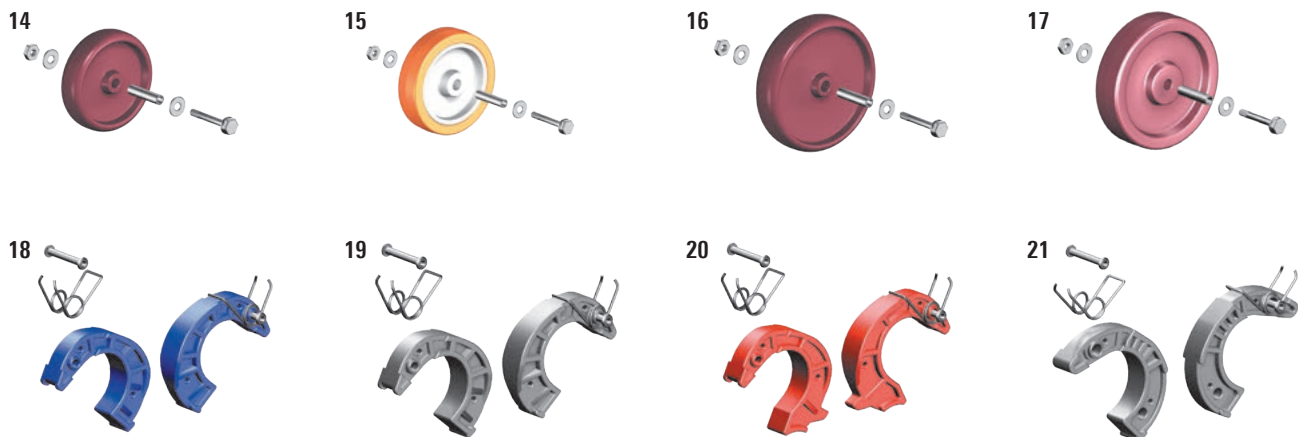

Pos.	Description	Dimensions L/H x W [m]	Weight approx. [kg]	Ref. No.	Zifa	Uni Light	Uni Compact	Uni Standard	Uni Wide	Uni Comfort	Stano	Alu br. beam 600
1	<b>Uni assembly hook</b> , pair.		1.2	<b>1300.001</b>	▶	▶	▶	▶	▶			
2	<b>Console bracket</b> , aluminium for widening of the work platform on one or two sides.	0.75 x 0.90	5.4	<b>1341.075</b>	📦			▶	▶			
3	<b>Double guardrail with toe board</b> , aluminium folds together for transport.	2.00 x 1.10	9.7	<b>1332.200</b>								▶
		3.00 x 1.10	12.9	<b>1332.300</b>								▶
4	<b>Guardrail fixture</b> , aluminium for fastening the double guardrail to the Alu bridging beam for Ref. No. 1332.xxx.	0.50	0.9	<b>1330.000</b>								▶
5	<b>Guardrail locking pin</b> , steel for securing the double guardrail with the guardrail fixture for Ref. No. 1330.xxx.		0.1	<b>1333.000</b>								▶
6	<b>Guardrail mounting standard</b> , aluminium for connecting the three-part brick guard made from scaffolding tubes, guardrail clamps and toe board.	1.20	2.4	<b>1334.000</b>								▶
7	<b>Clamp</b> , steel for connecting the Alu bridging beams Ref. No.1348.xxx.		0.4	<b>1331.000</b>								▶
8	<b>Tube pallet 125</b> steel, hot-dip galvanized, length of pallet posts: 0,86 m, load 1500 kg.	1.37 x 0.97	32.0	<b>5105.125</b>		▶	▶	▶	▶	▶	▶	▶
9	<b>Scaffolding lock</b> basic set, 10 locks, 2 keys and code card basic set, 20 locks, 2 keys and code card basic set, 50 locks, 4 keys and code card Expansion set with same locking as basic set, 10 locks Expansion set with same locking as basic set, 20 locks Expansion set with same locking as basic set, 50 locks		2.2	<b>4000.003</b>	🕒	▶	▶	▶	▶	▶	▶	▶
			4.2	<b>4000.004</b>	🕒	▶	▶	▶	▶	▶	▶	▶
			10.5	<b>4000.005</b>	🕒	▶	▶	▶	▶	▶	▶	▶
			2.1	<b>4000.011</b>	🕒	▶	▶	▶	▶	▶	▶	▶
			4.2	<b>4000.006</b>	🕒	▶	▶	▶	▶	▶	▶	▶
			10.5	<b>4000.007</b>	🕒	▶	▶	▶	▶	▶	▶	▶
10	<b>Identification sign</b> Block à 50 pcs.		0.5	<b>6344.400</b>	📦	▶	▶	▶	▶	▶	▶	
11	<b>See-through pocket</b> for Ref. No. 6344.200 and 6344.202, 10 pcs. 📦		0.35	<b>6344.010</b>	📦	▶	▶	▶	▶	▶	▶	
12	<b>LayPLAN Rolling Tower Configurator</b>		<b>on request</b>			▶	▶	▶	▶	▶	▶	

## Spare parts

Pos.	Description	Dimensions L/H x W [m]	Weight approx. [kg]	Ref. No.
14	<b>Wheel including axle</b> for Ref. No. 1308.150	dia. 0.15	0.6	<b>6491.511</b> 📦
15	<b>Wheel including axle</b> for Ref. No. 1309.150	dia. 0.15	0.6	<b>6491.501</b> 🕒
16	<b>Wheel including axle</b> for Ref. No. 1259.200 / 1259.201	dia. 0.20	0.9	<b>6491.512</b> 📦
17	<b>Wheel including axle</b> for Ref. No. 1260.200	dia. 0.20	1.1	<b>6491.513</b> 📦
18	<b>Finger 42 mm pair, blue</b> complete with springs and rivets.		0.2	<b>6491.416</b> 📦
19	<b>Finger 42 mm pair, grey</b> complete with springs and rivets.		0.2	<b>6491.417</b> 📦
20	<b>Finger 42 mm pair, red</b> complete with springs and rivets.		0.2	<b>6491.418</b> 📦
21	<b>Finger 48 mm pair, grey</b> complete with springs and rivets.		0.4	<b>6491.420</b> 📦

WS = wrench size PU = packaging unit 📦 = available ex works 🕒 = delivery time on request 📦 = only available in this packaging unit ▶ = included in tower kit ▶ = optional accessory for tower model

## Index

### A

Access deck	87
1.80 m	42, 44, 48, 49, 50, 54, 55, 56
2.85 m	62, 68
2.85 m	60, 61, 66, 67
Accesses	27
Access ledger	44, 56, 62, 68, 85
0.75 m	54, 55, 66, 67, 72
Access ledger 0.3 m	50
Adjustable base plate 60 with lock	83
Advance guardrail	89
Advance guardrail post	89
All-purpose boxes 1016	26
All-purpose ladder 3-part TOPIC 1040	16
Alu bridging beam	76, 77
Alu bridging beam 600 folding	77
Side protection	77
Alu bridging stairway, static or movable 114	32
Alu console bracket 0.75 m	78
Alu heavy-duty step TOPIC 1043.3	19
Alu maintenance platform	31
Alu stabilizer, extendable	44, 50, 56
Alu stairway	29
Alu start-stairway static or movable 110	28
Alu steps	19
Alu telescopic stage 1351	17, 77
1351	17
Angle reinforcement	19

### B

Ballast	42, 44, 48, 50, 54, 56, 60, 62, 66, 68, 72, 85
Base strut	85
1.80 m	54, 72
2.85 m	60, 66
Basic tube	
1.80 m	42, 48, 49, 54
2.85 m	60, 66
Beam	87
Bracket deck surface	78
Bridging deck	87
Bucket hook	13

### C

Car boot ladder TOPIC 1057	16
-------------------------------	----

Castor	
400	80
400 - 4 kN	42, 44, 48
700	80
700 - 7 kN	54, 60, 62, 66, 68
700 - 7kN	72
1000	80
with electro-conductive polyurethane coating	80
1200, with half-coupler	80
with tube connector	80
Castor 400	83
with polyurethane tyre	83
Castor 400 – 4 kN	50, 56
Castor 700	83
with polyurethane tyre	83
Castor 700 – 7 kN	72
Castor 1000	83
with electroconductive polyurethane coating	83
Castor 1200	
with half-coupler	83
Check plaque	23
Clamp	91
Colour variants	25
Combigrip ladder foot	6, 23
Combigrip spikes	15
Combination double ladder 1028	13
Combination single ladder 1029	10
Connecting strap	25
Connection between stile and rung	9
Console bracket	91
Convenient stairway access	36
Cross-piece castor	16, 18
Cross-piece castors	21

### D

Deck	87
1.80 m	42, 44, 48, 49, 54, 55, 72
2.85 m	68
2.85 m	60, 61, 66, 67, 78
Deck diagonal brace	87
Diagonal brace	87
1.95 m	42, 44, 48, 49, 50, 54, 55, 56
2.50 m	42, 44, 48, 50, 54, 56, 72
2.95 m	60, 61, 62, 66, 67, 68
3.35 m	60, 62, 66, 68
DIN EN 131-1	7
Double guardrail	87
1.80 m	48, 54
2.00 m	77
2.85 m	60, 66
3.00 m	77
Double guardrail with toe board	91
Double ladder	12, 13, 14, 15, 16
Double rung ladder TOPIC 1039	12
Double step ladder	14

Double step ladder with access on one side TOPIC 1044	15
Drywall installer	19

### E

End toe board	50, 56, 62, 89
0.75 m	42, 44, 48, 60, 78
1.44 m	68
1.44 m	66, 72
1.50 m	54
Engaging hook	11, 16
Extendable double ladder	16
Extension ladder TOPIC 1035	16

### F

Fastening bracket	25
Finger	
42 mm	91
48 mm	91
Folding	6
Folding ladder TOPIC 1056	15
Folding wooden steps 1055	19
Foot for cross-piece	23

### G

Grooving	6
Guardrail	50, 56, 87, 89
1.80 m	42, 44, 48, 49, 54, 55, 72
2.85 m	60, 61, 62, 66, 67, 68
Guardrail fixture	77, 91
Guardrail locking clip	77
Guardrail locking pin	91
Guardrail mounting standard	91
Gutter holder	21

### H

Handle assembly	26
Horizontal diagonal brace	87
1.95 m	42, 48
2.95 m	72
adjustable	72, 87

### I

Identification sign	91
Insert hook	21
Intermediate deck	78, 87
Intermediate guardrail	87

### K

Knee bar	15
----------	----

### L

Ladder control book	23
Ladder cross-piece	23

Ladder examination	7	<b>R</b>		Strut for outrigger	89
Ladder for Staro rolling tower	89	Ready-made tower	40	Sturdy pin joint	17
Ladder frame	85	Retrofit kit	23	Suspended bag	13
75/4 - 1.00 m	42, 44, 48, 50, 56, 60, 62, 78	Rollers with rubber tyre	11	Suspended bag with hook	21
75/8 - 2.00 m	42, 44, 48, 50, 56, 60, 62	Rolling towers	34, 35, 36, 37	Suspended step	12, 21
150/4 - 1.00 m	68	Roofer's ladder		Suspended step ladder	89
150/4 - 1.00 m	54, 66, 72	1046	24	Suspension hook	15, 21
150/8 - 2.00 m	68, 72	Roof ladder acc.to DIN 18160-5		Suspension ladder	85
150/8 - 2.00 m	54, 66	TOPIC 1049/1051	24		
Ladders and stairs	6	Rope control	11	<b>T</b>	
Ladder shoe		Rope extension ladder		Telescopic ladder	17
for wooden ladder	9	TOPIC 1037	11	Toe board with claw	89
Ladder shoe for wooden ladder	21	Rotary knob	12	1.80 m	42, 44, 48, 50, 54, 56, 72
Ladder support set	89	Rotation preventer	44, 50, 56, 62, 68, 89	2.85 m	62, 68
Ladder wall mounting	21			2.85 m	60, 66
Landing stairway	89	<b>S</b>		Toe board, wood	89
1.80 m	72	Safety hook		Tool bag	13
LayPLAN Rolling Tower Configurator	36, 91	model B	25	TOPIC 1035	11
Leg tube with castor 400	85	Modell Z	25	TOPIC 1037	11
Length adjustment rung by rung	17	Safety joint	16	TOPIC 1039	12
		Safety measure	38	TOPIC 1042	8
		Safety Structure P2	38, 39	TOPIC 1054	8
		Securing flaps	16	TOPIC Box	21
		See-through pocket	91	TOPIC-Box	12, 14
		Selection	36	TOPIC ladder foot	23
		Single ladder	8, 9, 10, 11, 16	TOPIC Stile Extension	21
		with wall clearance	16	Top rollers	21
		Single ladder wide		Tower support	89
		TOPIC 1054	8	Triangular rungs	6
		Single step ladder	8	Truck ladder	9
		Special joint	16	Tube pallet 125	91
		Spigot		Two-part extension ladder	11
		adjustable	85		
		Spike	21		
		Spring clip	42, 72, 78, 87	<b>U</b>	
		11 mm	48, 50, 54, 56, 60, 62, 66, 68	Uni assembly hook	38, 42, 44, 48, 49, 54, 55, 60, 61, 66, 67, 91
		Stabilizer	89	Uni Assembly hook	50, 56, 62, 68
		5 m	62, 68	Uni Comfort	36, 70, 72, 73
		extendable	62, 68, 89	Uni Comfort family	72
		Stairway	12	Uni Compact	36, 52, 54, 55
		Stairway access	70	Uni Compact family	54, 56
		Stairway access deck	87	Uni Compact retrofitting table	55
		1.80 m	72	Uni Compact with stabilizers	56, 57
		Stairway double ladder		Uni distance tube	87
		TOPIC 1061	12	Uni Lift 200	79
		Stairway guardrail	89	Uni Light	36, 46, 48, 49, 68, 69
		1.20 m	72	Uni Light family	48, 50
		3.07 m	72	Uni Light Retrofitting Table	49
		Staro basic tower	85	Uni Light with stabilizers	50, 51
		Staro deck	87	Uni Standard	36, 58, 60, 61
		Staro guardrail	87	Uni Standard family	60
		Staro rolling tower	36, 74, 75	Uni Standard retrofitting table	61
		Steel joint	15	Uni Standard with stabilizers	62, 63
		Step with access on one side	19	Universal label	23
		Stile extension	12, 17	Uni Wide	36, 64, 66, 67
		Stile section	6		
		Storage tray	15		

## Index

---

Uni Wide family	66, 68
Uni Wide retrofitting table	67
User manual	36

## V

VDE 0100	10, 13
----------	--------

## W

Wall bracket	21
Wallpaperer's trestle 1045	19
Warranty	6
Wheel including axle	91
Wide grooved rung	13
Window cleaner extension	21
Wooden double ladder	
1038	13
1038/1059.2	13
acc. to Ö-Norm Z1501	14
Wooden double ladder with wide rungs 1059.2	13
Woodensingle ladder	9
Wooden single ladder for builders 1036	10
Wood stile extension set EasyFix	21
Working platform	16
Work trestle	17

## Z

Zifa	36, 40, 42, 43
Zifa 75 basic tower	42, 44, 85
Zifa family	42, 44
Zifa with stabilizers	44, 45



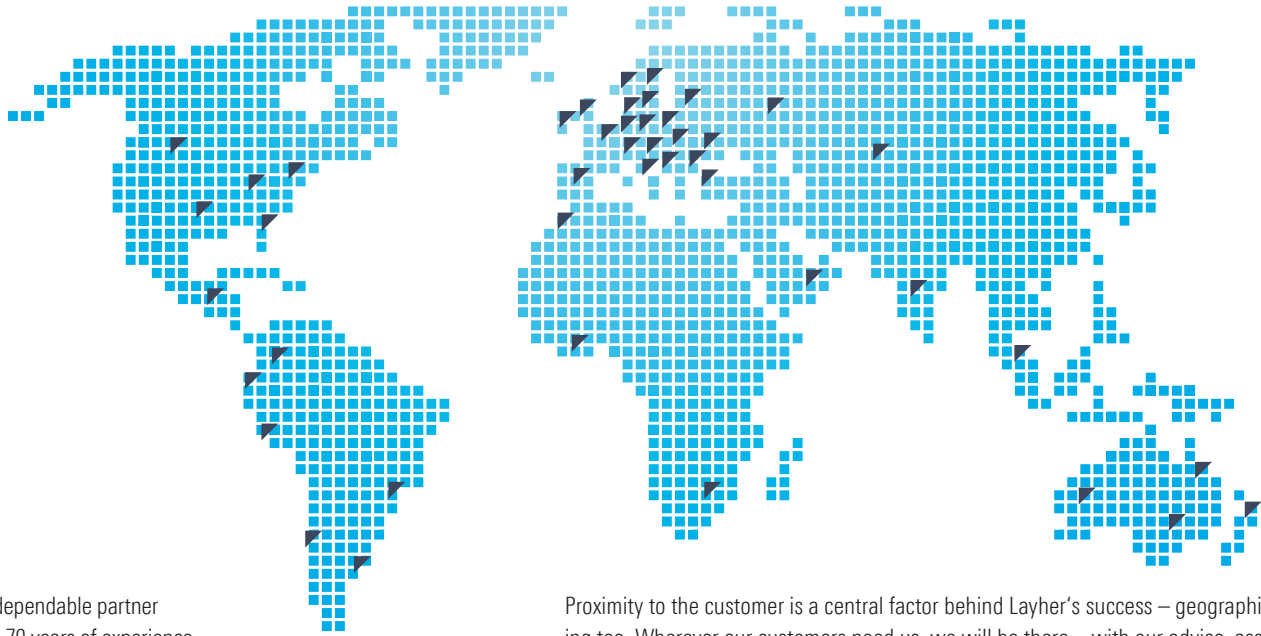

Layher is your dependable partner with more than 70 years of experience. "Made by Layher" always means "Made in Germany" too – and that goes for the entire product range. Superb quality – and all from one source.

Proximity to the customer is a central factor behind Layher's success – geographically speaking too. Wherever our customers need us, we will be there – with our advice, assistance and solutions.

-  **SpeedyScaf**
-  **Allround Scaffolding**
-  **System-free Accessories**
-  **Protective Systems**
-  **Shoring**
-  **Event Systems**
-  **Rolling Towers**
-  **Ladders**



Headquarter in Eibensbach



Plant 2 in Gueglingen



More Possibilities. The Scaffolding System.

**Wilhelm Layher GmbH & Co KG**  
Scaffolding Grandstands Ladders

Ochsenbacher Strasse 56  
74363 Gueglingen-Eibensbach  
Germany

Post Box 40  
74361 Gueglingen-Eibensbach  
Germany  
Telephone +49 (0) 71 35 70-0  
Telefax +49 (0) 71 35 70-4 59  
E-mail [export@layher.com](mailto:export@layher.com)  
[www.layher.com](http://www.layher.com)

