



Since 1961

PIPE INDUSTRIES INC.



*Glass Fiber Reinforced Polyester (GRP)
Pipes & Fittings*

INSTALLATION MANUAL



INDEX

| | |
|--|----------------|
| INTRODUCTION | 1 |
| 1.0 - TRANSPORTATION, UNLOADING, STORAGE | 2 - 13 |
| 1.1 - Transportation of pipes and fittings | 2 |
| 1.2 - Loading and unloading of pipes | 3 |
| 1.3 - Loading and unloading of couplings and fittings..... | 7 |
| 1.4 - Storage of pipes at job site..... | 8 |
| 1.5 - Unloading, handling and storage of nested pipes | 11 |
| 1.6 - Handling of lubricants | 13 |
| 1.7 - Transportation of pipes | 13 |
| 2.0 - SCHEMATIC ILLUSTRATION OF PIPE INSTALLATION STEPS | 14 - 16 |
| 3.0 - TRENCH EXCAVATION AND PREPARATION FOR PIPE INSTALLATION | 17 - 26 |
| 3.1 - Basics of installation | 17 |
| 3.2 - General information on trench excavation | 19 |
| 3.3 - Sheet pile application during trench excavation | 21 |
| 3.4 - Preparation of trench bedding | 22 |
| 3.5 - Trench width | 23 |
| 3.6 - Multiple pipe installation in a single trench | 23 |
| 3.7 - Cross-over of pipes | 24 |
| 3.8 - Trench depth | 25 |
| 3.9 - Unstable trench bottom | 26 |
| 3.10 - Overflowing trench | 26 |
| 4.0 - BEDDING AND BACKFILLING MATERIAL CLASSIFICATION | 27 - 28 |
| 5.0 - INSTALLATION OF PIPES AND FITTINGS | 29 - 45 |
| 5.1 - Pre-installation stage | 29 |
| 5.2 - Lowering pipes onto the trench bed | 30 |
| 5.3 - Pipe installation | 31 |
| 5.4 - Angular deflection | 37 |
| 5.5 - Flanged joints | 38 |
| 5.6 - Fitting connections | 39 |
| 5.7 - Trenching on slopes | 44 |
| 6.0 - CONNECTION OF PIPES WITH RIGID STRUCTURES | 46 - 48 |
| 6.1 - Repair/Pipeline closure pipes | 48 |
| 7.0 - SITE CONTROLS AFTER INSTALLATION | 49 - 58 |
| 7.1 - Checking vertical deflection | 49 |
| 7.2 - Detecting (measuring) deflection | 50 |
| 7.3 - Field hydrotesting | 51 |
| 7.4 - Filling the pipeline for hydrotesting | 54 |
| 7.5 - Allowable leakage | 55 |
| 7.6 - Taking pipeline into operation | 55 |
| 8.0 - JOBSITE SAFETY PROCEDURES | 59 - 62 |
| 8.1 - Pre installation stage | 59 |
| 8.2 - Installation stage | 60 |
| 8.3 - While entering into a pipeline | 60 |
| 8.4 - During repairs at job site | 61 |
| 8.5 - Storage of chemical and raw materials | 62 |



INTRODUCTION

The purpose of this manual is to guide field teams to perform a proper installation of SUPERLIT GRP pipes, couplings and fittings.

While using this manual, solid engineering practices and common sense should always be taken into consideration and information provided on this manual should only be used as a guidance. Specifications prepared for a particular project will always have a priority over the general guidelines mentioned herewith. In case of a conflict or a contradiction, please contact SUPERLIT Project Design and Site Support Department.

SUPERLIT recommends a whole study and evaluation of this manual before the start up of any jobsite activity. In case of a need for further clarifications or practical trainings, SUPERLIT ACADEMY is ready for your service. To get information about Superlit Academy or to join Academy Programs, please contact SUPERLIT staff.

With the company's core principle of "Sustainable Superior Quality in Production and Service", SUPERLIT Project Design and Site Support Department teams are always at your disposal whenever engineering support or supervision is needed for project design, loading & unloading, handling, transportation, storage and installation of pipes.

SUPERLIT
PROJECT DESIGN and SITE SUPPORT
project@superlit.com

SUPERLIT
SALES TEAM
sales@superlit.com

SUPERLIT Pipe's commitment on compliance with relevant standards and performance criteria is valid if the pipe installation is performed in line with this manual. SUPERLIT Pipe keeps the right to change any part of this document or as a whole, without prior notification.



TRANSPORTATION, UNLOADING, STORAGE

1.1 – TRANSPORTATION OF PIPES AND FITTINGS

While transporting, moving, loading & unloading pipes and fittings at jobsite, maximum care should be exercised to avoid any structural damage. The following points should be considered during these operations:

- a) Identify proper lifting points and methods.
- b) Identify proper moving methods and vehicles.
- c) Visually control each moved item for damages or cracks.
- d) Compare and control total quantity of moved or transported items with the order quantity.
- e) Report any damage or a missing item.

Damaged goods should
not be used unless
inspected and repaired
by SUPERLIT personnel.



1.2 - LOADING AND UNLOADING OF PIPES

Loading and unloading operations are critical issues, therefore, techniques which will be used during these operations should be determined based on site conditions. While loading or unloading and placing pipes on the ground, prevent any impact with rigid objects to avoid structural damage.

Loading and unloading of pipes with $DN \geq 300\text{mm}$ should be exercised with an appropriate loading equipment or machine.

Based on pipe diameters, lengths and weights, as well as jobsite conditions, crane-lifting strap method or forklift can be used for these operations.





Loading and unloading with crane and lifting strap: Pipes can be lifted either with one or two lifting straps, however, for an easier balancing control while lifting, two lifting straps usage is recommended. With one lifting strap, the strap should be fastened at pipe's center of gravity. With two lifting straps, fastening points should be as per illustration on next page. Both methods should be exercised very carefully, fastening points should be controlled and secured. To prevent any possible accidents, ensure that there is nobody under the pipe while lifting.

Guide ropes tied around the pipe can be used to have manual control over the pipe while it is in the air. This method is strongly advised particularly in high winds. Pipe direction control with guide ropes should be performed at a distance, should not be done from underneath the pipe.





GLASS FIBER REINFORCED POLYESTER (GRP) PIPES & FITTINGS INSTALLATION MANUAL

1.0

TRANSPORTATION - UNLOADING - STORAGE

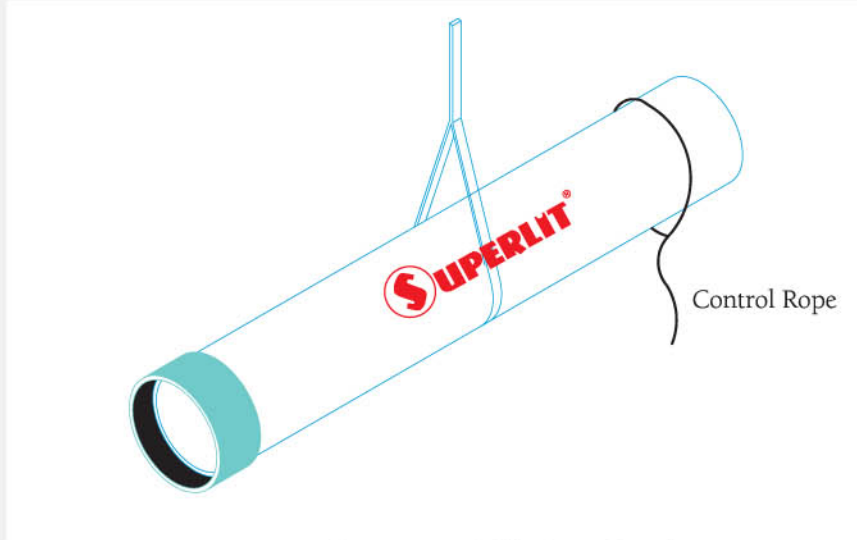

Figure 1 : One lifting strap method (with a guide rope)

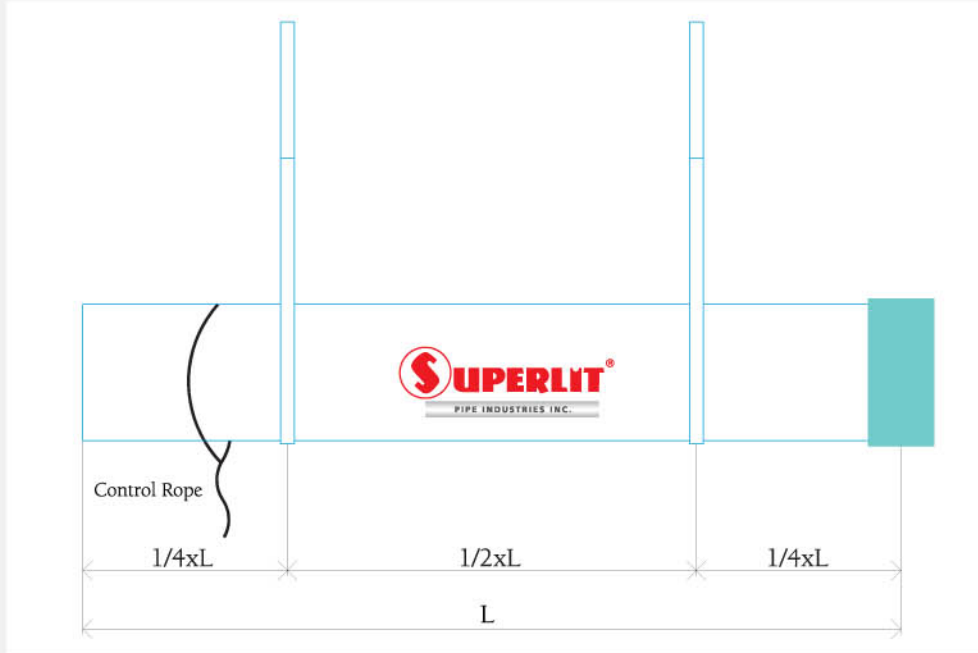

Figure 2 : Two lifting straps method (with a guide rope)



Loading and unloading with forklift

This method is generally used for factory loadings or for wagon loadings of railway transportation. However, since there is generally no need for a forklift at infrastructure jobsites, unloading at jobsites is performed with crane-lifting strap method.

Ensure that forklift is operated by a licensed forklift operator.

Pipes should be placed on wooden cradles, and forklift should lift the pipe with the cradle as shown on below pictures.





1.3 – LOADING AND UNLOADING OF COUPLINGS AND FITTINGS

SUPERLIT GRP pipes are generally delivered with a coupling installed on one end. If there is a special requirement or if additional couplings are required, couplings can be delivered separately as bundles.

Regardless of its dimensions, every fitting should be carried and unloaded with maximum care. In case fittings are delivered plain (without external packaging), determination of lifting points and unloading techniques are critical issues. For unloading of fittings with packaging, pipe unloading methods can be used. In any case, center of gravity and balanced distribution of mass factors should always be taken into account while lifting, loading and unloading of fittings.





1.4 – STORAGE OF PIPES AT JOB SITE

- ④ Storage area should be flat, leveled and clear of objects such as rocks, stones, sharp edges, etc.
- ④ Pipes can be stored in piles to minimize the storage area within the allowed limits.
- ④ While storing pipes as piles, wooden cradles should be placed between pipe levels. The first level pipes should be supported with wooden wedges to prevent sliding.
- ④ It is recommended to store pipes on flat timbers to facilitate placement and removal of lifting slings around the pipe, as well as easy handling of pipes with a forklift.
- ④ Flat timbers should be placed at a distance of 1/4 of pipe length from each pipe end.
- ④ If couplings are delivered as bundles, couplings should be stored at horizontal position to prevent radial deflection.
- ④ The storage ground should be resistant to heavy loads and should not be exposed to strong winds.
- ④ Maximum piling height is around 2,5 meters. It is not recommended to store pipes as piles for diameters bigger than DN 1200 mm.



Change of pipe's round form to oval form as a result of vertical loads is defined as "vertical deflection" and calculated as follows:

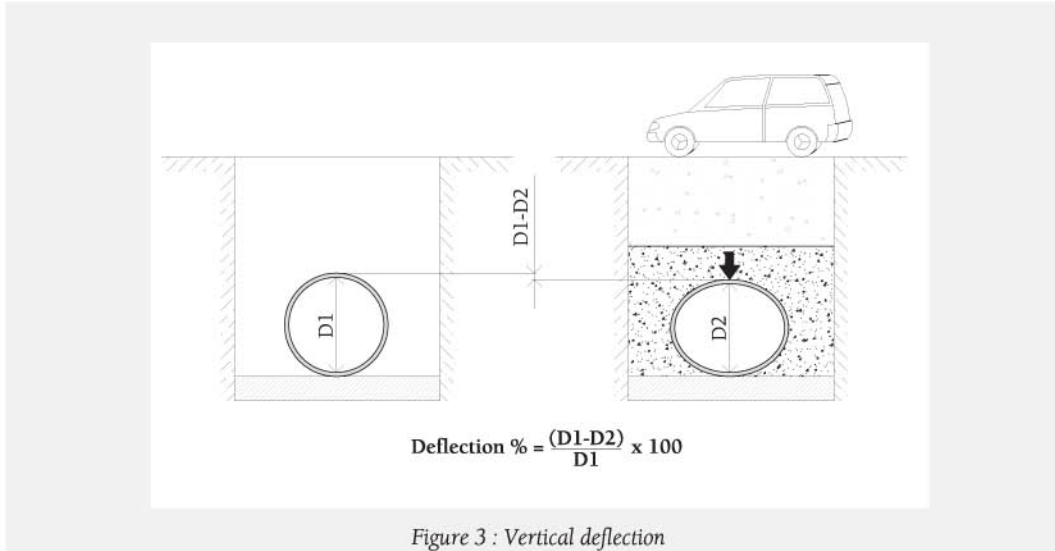

Maximum allowed vertical deflection should not exceed below values while storing the pipes as piles (stacks).

| Stiffness Class | Maximum Deflection |
|-----------------|--------------------|
| 2500 | 2.5 |
| 5000 | 2.0 |
| 10000 | 1.5 |

Table 1: Maximum vertical deflection

Another way to describe storage height is to express the number of stacking layers.

| Diameter DN (mm) | Maximum number of stacking layers | |
|---------------------|-----------------------------------|-----------------|
| | SN 2500 | SN 5000 & 10000 |
| 200-450 | 4 | 5 |
| 500-700 | 3 | 4 |
| 700-900 | 2 | 3 |
| 1000-1200 | 2 | 2 |
| >1500 | 1 | 1 |

Table 2: Maximum number of stacking layers



TRANSPORTATION - UNLOADING - STORAGE

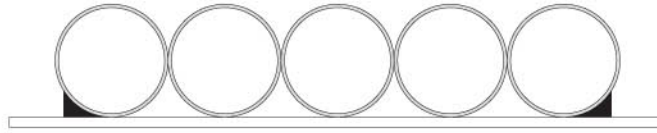

Figure 4 : Storage of pipes as a single level

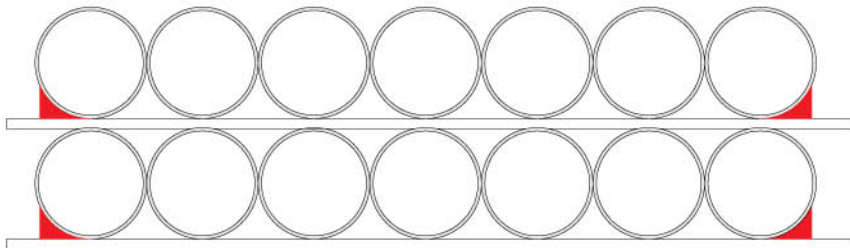

Figure 5 : Storage of pipes as piles (2 layers)



1.5 – UNLOADING, HANDLING AND STORAGE OF NESTED PIPES

Pipes which will be shipped to far destinations can be shipped as nested (smaller diameter pipe placed inside bigger diameter pipe) to reduce transportation costs. Nested pipes are packed in a special way and may require case specific procedures for unloading, handling, storing and transporting.



General recommendations are as follows:

- a) Always use 2 lifting slings while lifting nested pipes. Since the weight of nested pipes will be much higher than the weight of a single pipe, ensure that lifting slings are strong enough to handle the total load. Consult SUPERLIT for lifting points and lifting method for nested pipes.
- b) Storing pipes as nested is a preferred application in many cases due to less storage cost and space. However, do not store nested pipe bundles as stacks and always store nested pipes as a single level.
- c) To prevent movement of inner pipes while transporting, special packaging techniques are used for nested pipes. Do not release original packaging of nested pipes until installation.



- d) Before denesting inner pipes, be sure to remove all packaging such as steel strips, wooden wedges, sand bags etc. without damaging pipes.
- e) The most common technique used for denesting pipes is using a forklift with a padded boom fixed on one of its forks. The padded boom installed on the fork is generally a steel tube covered with plastic. Before denesting pipes, be sure that the forklift lifting capacity is sufficient for this operation.

Denesting operation can be described as follows: Forklift operator places the boom inside the most inner pipe without touching the pipe walls, then starts lifting the boom very slowly. The boom lifts the pipe slightly until the lifted pipe becomes completely loose inside the outer pipe. By driving forklift backwards, lifted pipe is taken out of the bundle. After each denesting, pipes should be visually controlled for damages. To keep the pipe bundle stable, it is recommended to perform denesting operation at a denesting station.

If weight, length of the pipes or the unloading equipment capacity do not allow above described denesting operation, please consult SUPERLIT Project Design and Site Support Department for special denesting procedures.

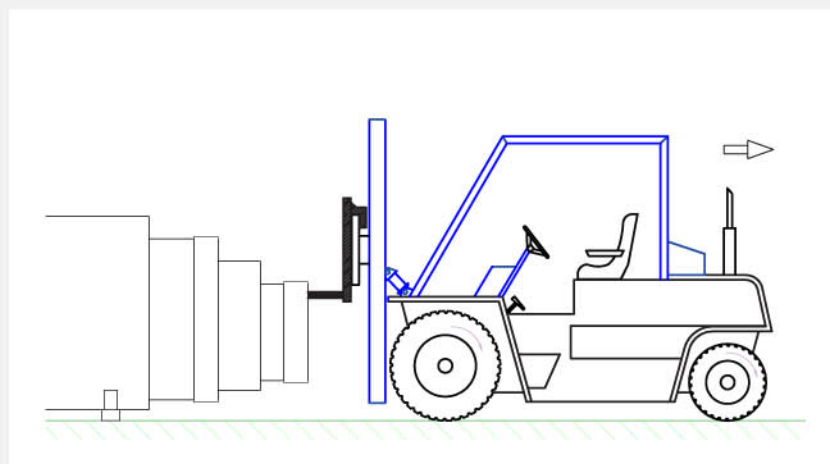

Figure 6 : Denesting with a forklift



1.6 – HANDLING OF LUBRICANTS

Lubricants used for pipe and coupling installation should always be stored in their original packaging. During transportation, make sure that the original packages are mounted tightly and not subject to any damage or leakage.

1.7 – TRANSPORTATION OF PIPES

Transportation vehicle should never be loaded over capacity while transporting pipes. To prevent any structural damage due to the movement and vibration during transportation, pipes should be detached from each other. To keep stability and to prevent movement, pipes should be tightly packaged and supported with wooden wedges. Maximum loading height for pipes is 2,5 meters.

Pipe bundles should be fastened on the vehicle with pliable straps or ropes over the support points. If steel strips or chains are used for fastening, place fabric pads between the strips / chains and the pipe to prevent abrasion. Maximum deflection values during loading and transportation should not exceed the values given on Table 1.

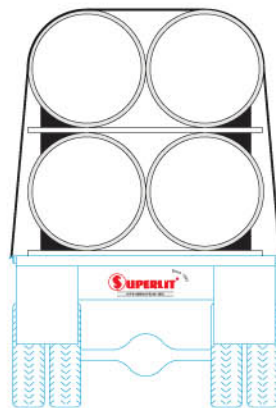
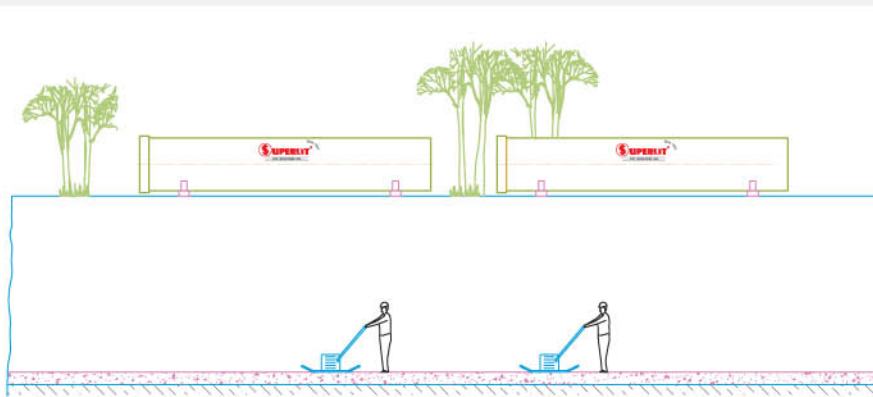

Figure 7 : Pipes loaded on truck



SCHEMATIC ILLUSTRATION OF PIPE INSTALLATION STEPS

In this section, pipe installation steps are described briefly with drawings to give a general overview. At further sections, installation steps mentioned hereby are explained in details.



1. Prepare trench bottom for bedding.

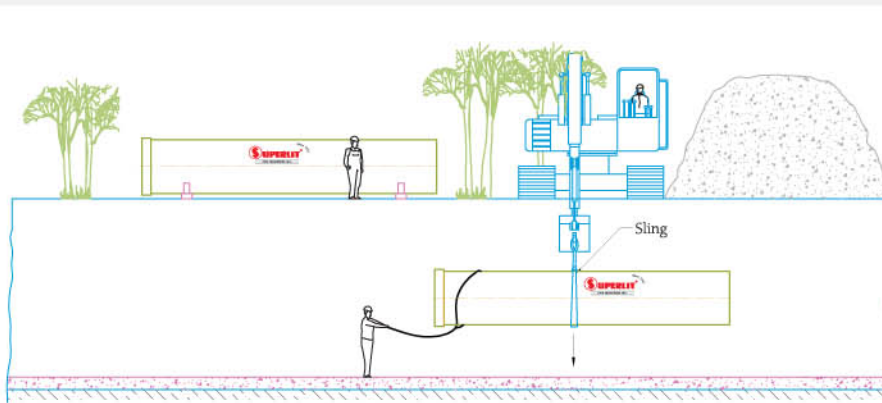

2. Lower pipe into the trench using fabric strap.



GLASS FIBER REINFORCED POLYESTER (GRP) PIPES & FITTINGS INSTALLATION MANUAL

2.0

SCHEMATIC ILLUSTRATION OF PIPE INSTALLATION STEPS

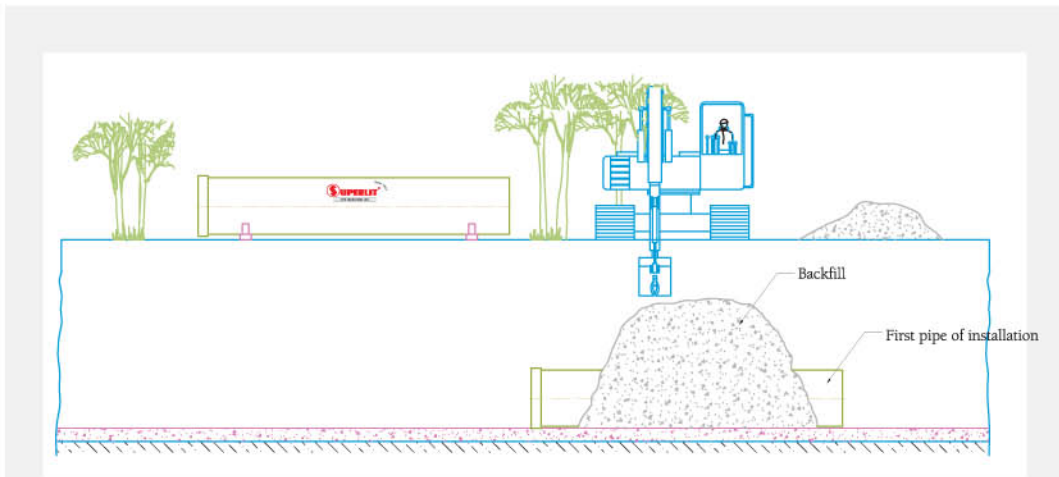

3-Fix the first pipe with backfill material.

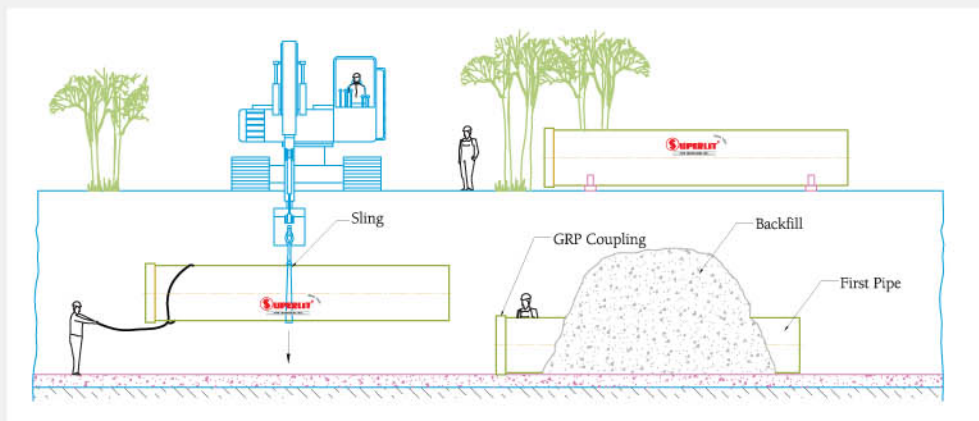

4 - Lower the second pipe into the trench using fabric strap.



SCHEMATIC ILLUSTRATION OF PIPE INSTALLATION STEPS

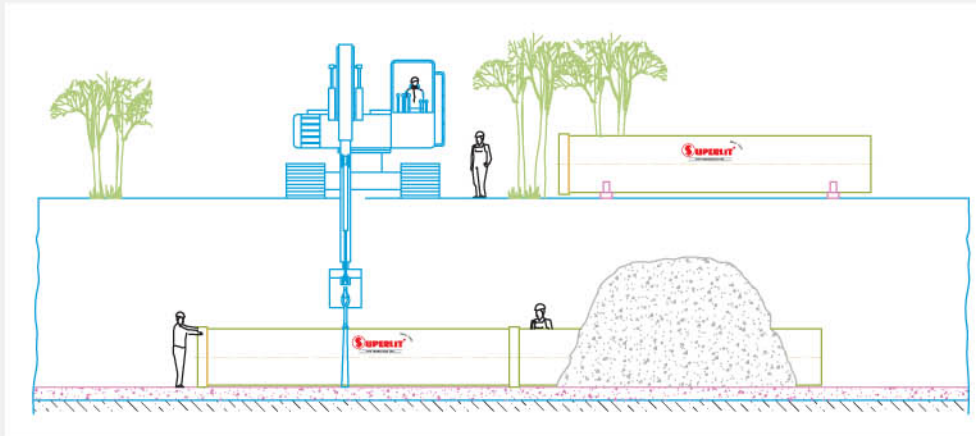

5-Align pipe with pipeline axis.

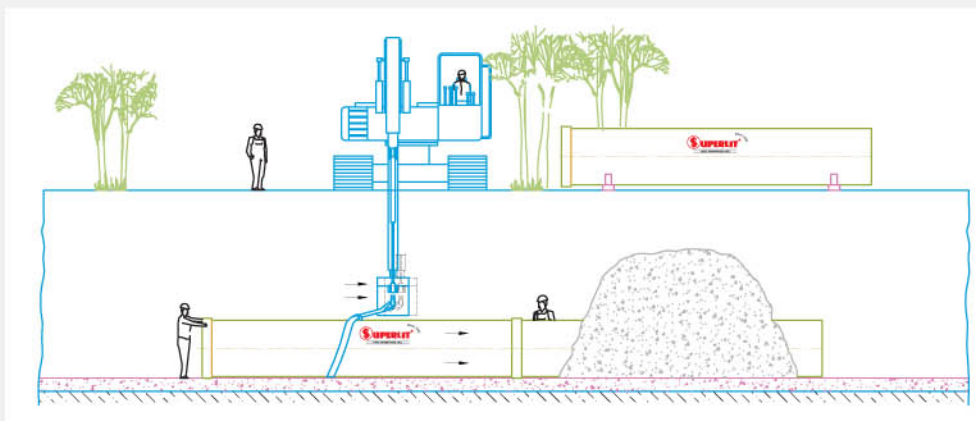

6-Push pipe spigot into the coupling.



TRENCH EXCAVATION AND PREPARATION FOR PIPE INSTALLATION

Pipe installation methods for SUPERLIT GRP pipes vary based on stiffness, burial depth, native soil characteristics and backfill material.

Initial and long term vertical deflection values should never exceed values given on Table 1, regardless of the installation method and conditions. Otherwise, pipe performance might not meet the expectations.

3.1 - BASICS OF INSTALLATION

SUPERLIT GRP pipes are designed to provide a continuous excellent performance for long years if the installation is performed correctly as per the instructions. Therefore, trenching, bedding and backfilling specifications and methods should be evaluated very carefully.

Engineers have found out through considerable experience that ideal materials for bedding and backfilling are properly compacted granular materials. However, to reduce field costs, excavated trench soils are very often used as pipe zone backfill. In such a case, excavated trench soils should be analyzed to determine the suitability of usage as backfill material.

SUPERLIT engineers always recommend compacted granular material for bedding and backfilling.



TRENCH EXCAVATION AND PREPARATION FOR PIPE INSTALLATION

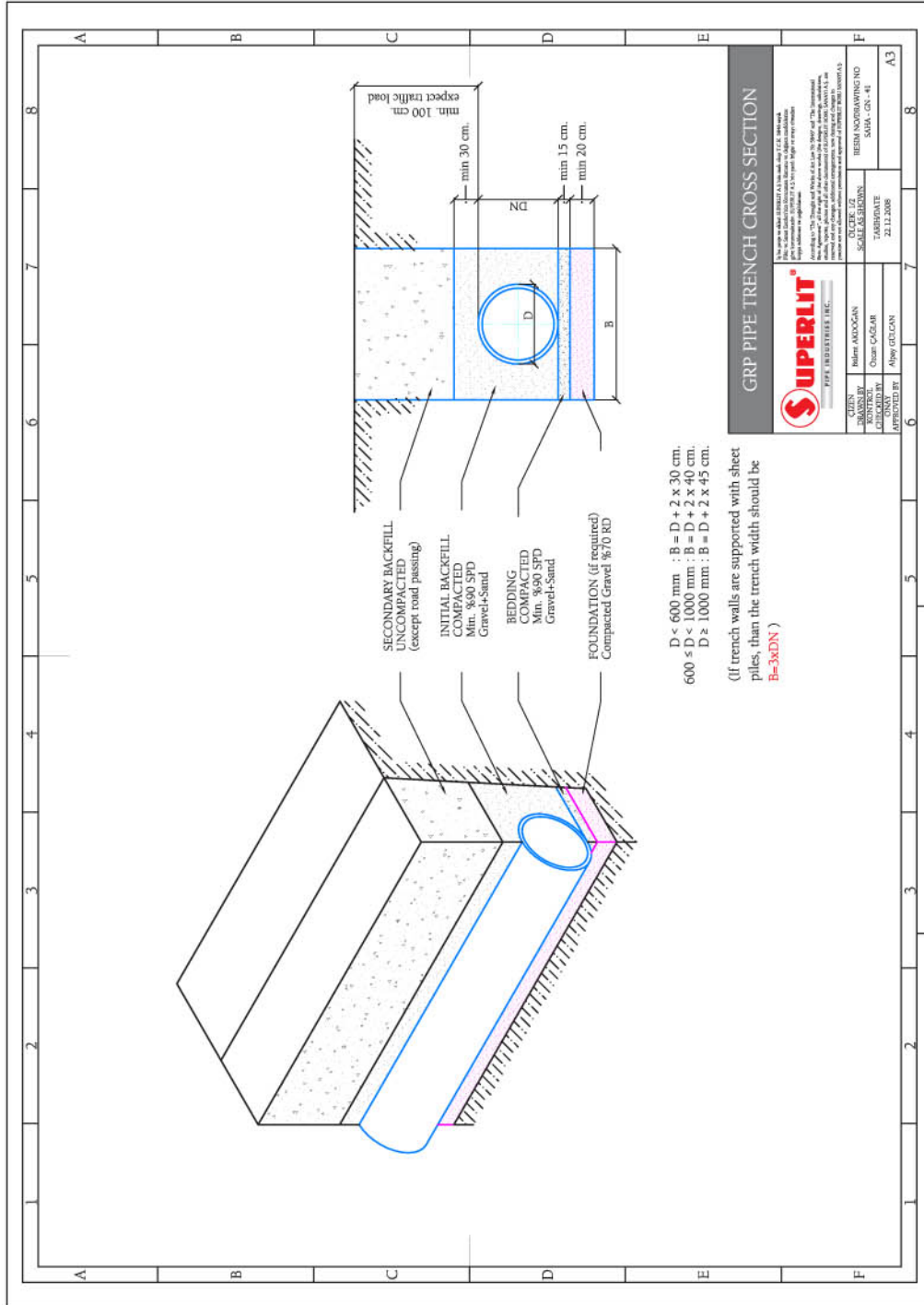

Figure 8: GRP Pipe trench cross section



TRENCH EXCAVATION AND PREPARATION FOR PIPE INSTALLATION

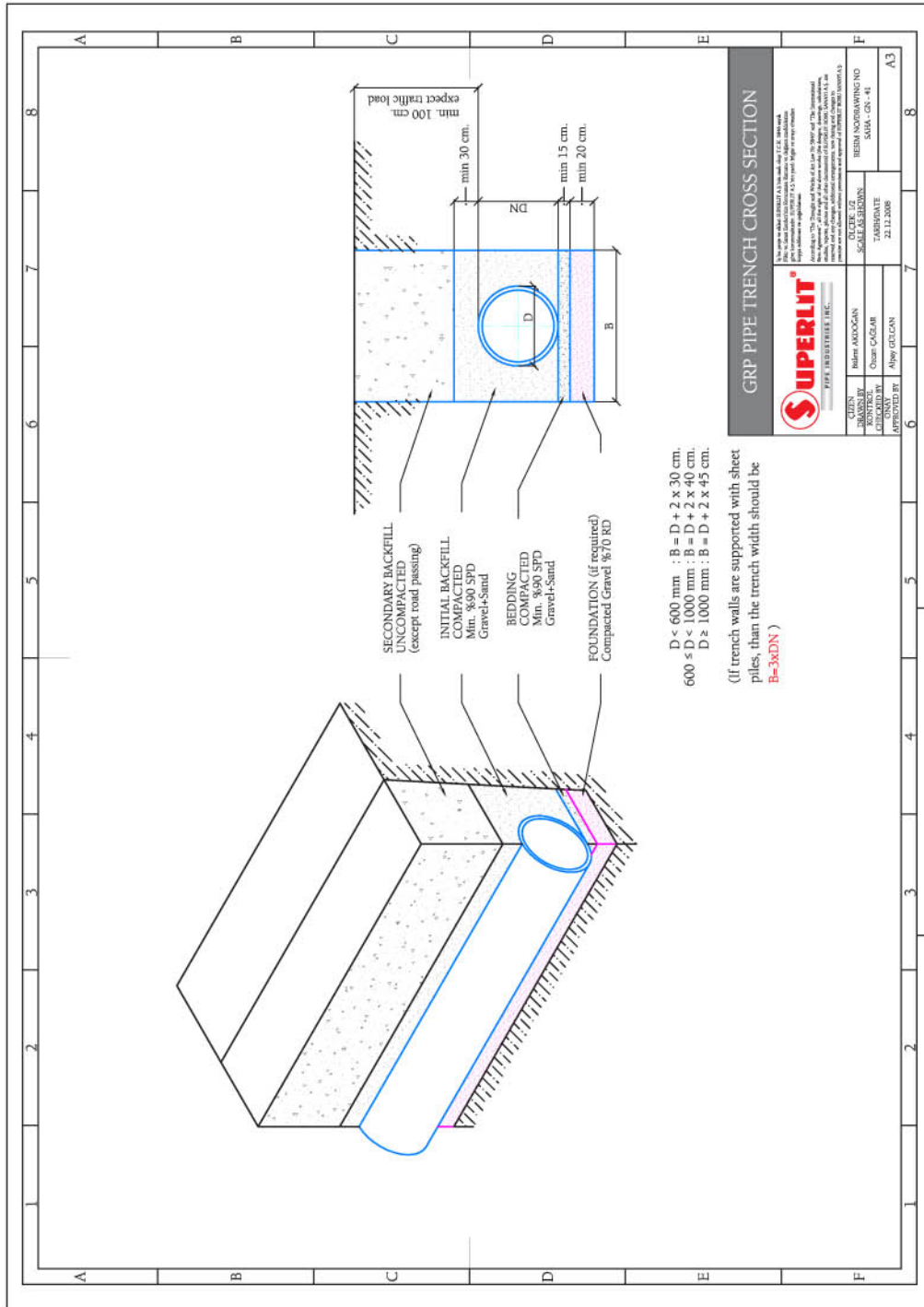

Figure 8: GRP Pipe trench cross section



3.2 - GENERAL INFORMATION ON TRENCH EXCAVATION

Following points should be considered during trench excavation:

- ④ Take necessary safety precautions to ensure a safe working environment. Prevent water penetration into the trench.
- ④ During excavation, make sure that trench walls keep vertical position.
- ④ For a flat bedding, remove all obstacles and sharp edges such as rocks, gravels, concrete, etc. from the trench.
- ④ Remove all organic items such as plants, tree roots, etc. from trench ground.
- ④ Ensure that trench ground is strong and stable.
- ④ If the trench ground is not stable enough, increase trench depth for stabilization works.
- ④ Discharge water (if there is any) from the trench before bedding preparation.
- ④ When the underground water level is high, it might cause pipes to float. To prevent floatation, increase the trench depth to increase the height of backfilling.
- ④ Ensure that trench width is sufficient enough for bedding and backfilling compaction works.
- ④ Ensure that excavated materials are piled at a distance from the trench to avoid the possibility of rolling back into the trench.



TRENCH EXCAVATION AND PREPARATION FOR PIPE INSTALLATION



Trench ground stabilization works (Foundation)



Bedding after ground stabilization



3.3 – SHEET PILE APPLICATION DURING TRENCH EXCAVATION

Trench walls should be supported with sheet piles if the natural ground soil is loose or unstable, underground water level is high, or trench depth is higher than standard conditions. However, during removal of the sheet piles, backfill compaction is subject to disruption which decreases the pipe support. To overcome this problem, removal of the sheet piles should be done step by step and after each sheet pile removal, backfilling should be controlled and compacted until desired compaction level is reached.

Crushed rock is recommended as backfilling material for trenches where sheet piles are used. Since underground water level is generally high in these types of trenches, crushed rock size should be big enough to resist water washout.

SUPERLIT engineers advise trench width, where sheet piles are used, as “DN+2m” up to nominal pipe diameter DN 1000 and as “3xDN” for nominal pipe diameter DN 1000 and above.





3.4 - PREPARATION OF TRENCH BEDDING

Trench bedding should be flattened, leveled and compacted all along the trench. Under unstable soil conditions, trench depth and bedding thickness can be increased.

After trench excavation, bedding should be prepared to provide durable and stable support for pipe. Pipe bedding should not be less than 15 cm in height and should be prepared with compacted granular material at minimum 90% Standard Proctor Density or any other suitable bedding material at minimum 95% Standard Proctor Density.

Bedding depth should be increased if there are unstable, loose or soft soil conditions. If bedding material is sandy, bedding material should be moisturized and should be compacted with vibrating compactors. Bedding should always be flat and leveled with the trench bottom.





TRENCH EXCAVATION AND PREPARATION FOR PIPE INSTALLATION

3.5 - TRENCH WIDTH

Trench width should be wide enough to place fittings and connection parts, and to allow a convenient working space for field teams for compaction. For standard installations, minimum trench width is advised as follows:

DN < 600, Trench width = DN + (2 x 300 mm)

DN < 1000, Trench width = DN + (2 x 400 mm)

DN ≥ 1000, Trench width = DN + (2 x 450 mm)

If there are unstable, loose or soft soil conditions, based on the pipe stiffness and trench depth, trench width can be increased.



3.6 – MULTIPLE PIPE INSTALLATION IN A SINGLE TRENCH

During installation of multiple pipes in a single trench, distance between any of the two pipes is determined with the formula $(r_1 + r_2) / 2$ whereas r_1 : radius of the first pipe and r_2 : radius of the second pipe. Complying with the formula, SUPERLIT recommends below values for the distance of pipes in the same trench:

| Diameter (mm) | Minimum distance between pipes (mm) |
|-------------------|-------------------------------------|
| 200 - 160 | 300 |
| 700 - 1200 | 600 |
| 1300 - 2000 | 1000 |
| 2100 - 3000 | 1500 |
| 3000 mm and above | 2000 |

Table 3: Minimum distance between pipes



3.7 – CROSS-OVER OF PIPES

In case of cross over of pipes (one pipe crossing over the other pipe), minimum distance between two pipes should be determined as per below illustration and formula.

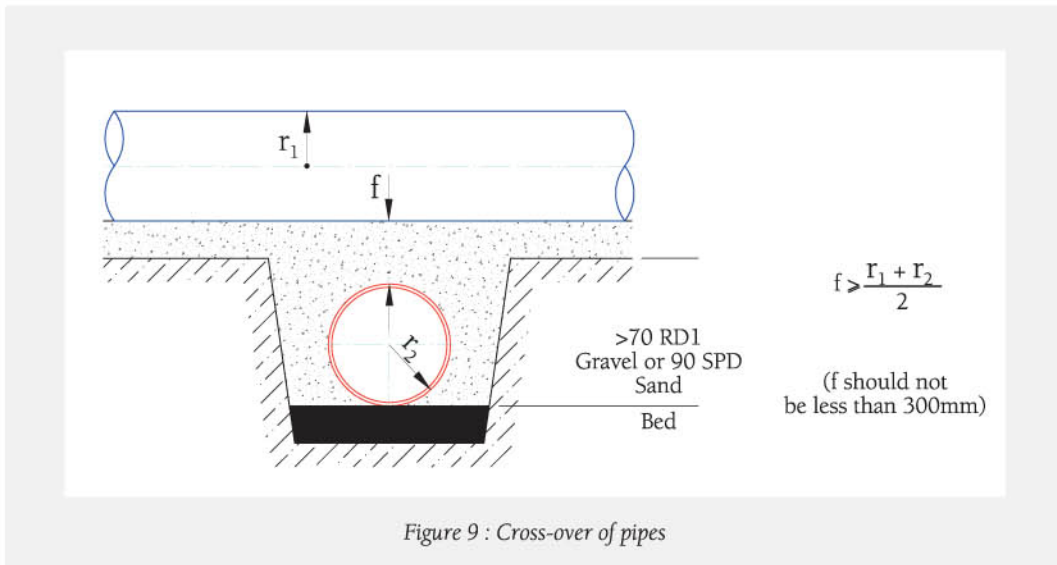

Figure 9 : Cross-over of pipes

There are some cases where a new pipeline route passes underneath an existing pipeline. In such cases, operation of existing pipeline should be shut down (if possible) and excavation should start only after stabilization of the existing pipeline with supports. The new pipes should be lowered into the trench without interacting with the supports and should be laid slowly underneath the existing pipeline.

After placing new pipes, backfill material should be applied to close the gap between the two pipes and should be compacted by hand. It is also recommended to add a small amount of cement in the backfill material.



TRENCH EXCAVATION AND PREPARATION FOR PIPE INSTALLATION

3.8 – TRENCH DEPTH

While determining the trench depth, factors such as intended purpose of service, design of pipeline, pipe characteristics, trench soil characteristics, static-dynamic load combinations should be taken into consideration.

Trench depth should be sufficient to prevent conveyed fluids to freeze. Sufficient cover (backfill and final backfill) should be provided to prevent pipe flotation in potentially high ground water areas. Generally accepted trench depths are as follows:

| Pipe stiffness (SN) | Trench depth (m) |
|---------------------|------------------|
| 2500 | 1 - 3 |
| 5000 | 1 - 5 |
| 10000 | 1 - 7 |

Table 4 : Trench depth

| Surface loads | Live (wheel) load | | Min. trench depth | |
|----------------|-------------------|---------|-------------------|--|
| | Kilo Newton | lbf | meter | |
| AASHTO H20 (C) | 72 | 16,000 | 1.0 | |
| BS 153 HA (C) | 90 | 20,000 | 1.5 | |
| ATV LKW 12 (C) | 40 | 9,000 | 1.0 | |
| ATV SKW 30 (C) | 50 | 11,000 | 1.0 | |
| ATV SLW 60 (C) | 100 | 22,000 | 1.5 | |
| Cooper E80 | | Railway | 3.0 | |

Table 5 : Minimum trench depth



3.9 – UNSTABLE TRENCH BOTTOM

If the trench bottom contains loose or montmorillonit type soils, trench bottom is described as “unstable bottom”. In such cases, unstable trench bottom should be stabilized, if possible, loose soil should be removed. If there is no possibility to remove the loose soil, then penetration of underground water into trench bottom should be prevented with drainage systems. Trench bottom should also be supported and stabilized against precipitation by forming bottom foundation layers.

Gravels or crushed rocks can be used to form bottom foundation layers. Height of the foundation should be minimum 20 cm and can be increased based on trench bottom soil characteristics. Standard bedding should be applied over the foundation layer.

To prevent loss of pipe support and to strengthen foundation, filter cloth or geotextile can be laid onto foundation. In addition, pipe lengths should not exceed 6 meter at unstable trench bottom conditions.

3.10 – OVERFLOWING TRENCH

If the ground water level is rising onto the trench bottom, this case is described as “overflowing trench”. Under this condition, ground water level should be decreased at least 20 cm below the trench bottom before bedding preparation. Gravel or crushed rock should be used for bedding and backfill in such trenches. However, crushed rock size should be big enough to resist dragging with the water flow. Pipes are subject to floatation in overflowing trenches. Therefore, backfill & final backfill height and Standard Proctor Density should be increased. In some cases, placement of additional weights onto the final backfill might be needed to prevent floating of pipes.



BEDDING AND BACKFILLING MATERIALS

Bedding and backfilling materials are classified as follows according to AWWA M45, Fiberglass Pipe Design, Manual of Water Supply Practices.

Soil stiffness category SC1 : Crushed rock containing less than 15% of sand. (maximum 25% passing through 9.5 mm sieve and maximum 5% passing through No.200 sieve)

Soil stiffness category SC2 : Clean, coarse-grained soils (SW, SP, GW, GP and similar soil with maximum 12% passing No. 200 sieve)

Soil stiffness category SC3 : Clean, coarse-grained soils (SW, SP, GW, GP and similar with minimum 12% passing No. 200 sieve)

or

Sandy or gravelly fine-grained soils (CL, ML, CL-ML type soils with minimum 30% retained on a No 200 sieve)

Soil stiffness category SC4 : Fine-grained soils (CL, ML, CL-ML type soils with maximum 30% retained on a No. 200 sieve)

Soil stiffness category SC5 : Highly plastic and organic soils (MH, CH, OL, OH, PT)



BEDDING AND BACKFILLING MATERIALS

SC1 type soils, with low sand and fine containment, provides maximum pipe support based on the compaction level. Compaction of the material is easy and displays maximum support even under moisturized conditions.

SC2 type soils, with a high compaction level, displays a high pipe support.

SC3 type soils display lower pipe support compared to SC1 and SC2 category soils. Compaction requires effort and high moisture conditions decrease the pipe support level.

SC4 type soils require geotechnical evaluation before used for bedding or backfilling. Compaction is difficult and desired level of compaction is directly dependent on moisture conditions. This type is of soils are not suitable for bedding or backfilling at high backfilling levels, under traffic loads and if there is ground water in the trench.

SC5 type soils are not suitable for bedding or backfilling.

Bedding material characteristics are very important for a proper support for the pipes. Generally bedding and backfilling materials are preferred to have the same characteristics. If the excavated material is preferred to be used as backfilling material, characteristics of the excavated soil should be analyzed for suitability. Another critical point to be taken into consideration is the possibility of experiencing different soil characteristics along the pipeline.

| Nominal diameter (DN) | Maximum particle size (mm) |
|-----------------------|----------------------------|
| DN \leq 450 | 13 |
| 450 < DN \leq 600 | 19 |
| 600 < DN \leq 900 | 25 |
| 900 < DN \leq 1200 | 32 |
| 1200 < DN | 38 |

Table 6 : Maximum particle size



INSTALLATION OF PIPES AND FITTINGS

5.1 – PRE-INSTALLATION STAGE

After completion of trench excavation and bedding, installation can start in line with the project. Pipes and fittings should be stored along the pipeline next to the trench according to the daily installation program for a faster and easier installation. Stored goods should not block working path of the construction machines such as crane, excavator, bulldozer, etc.





5.2 – LOWERING PIPES ONTO THE TRENCH BED

Lifting straps should be tied around the pipe from appropriate lifting points. While lifting fittings, special lifting and alignment requirements should be taken into consideration. (For instance, the arm angle of the Tee part). Lifting can be performed with a crane or with the excavator arm and pipe should be lowered onto the bedding slowly. During lifting and lowering inside the trench, field teams instruct directions to the excavator operator to make sure that pipe will be placed at the right location. Pipe should be lowered closer to the previously installed pipe and should be carefully aligned.





5.3 – PIPE INSTALLATION

SUPERLIT GRP pipes are delivered with a coupling installed on one end, if not required otherwise.

- ④ Clean pipe ends from dust and dirt. Visually check pipe ends for delamination. (Delamination is partition of pipe layers)
- ④ Clean rubber gasket and remove any stones, gravel or dust from the grooves of the gasket.
- ④ Apply lubricants on the gasket with a piece of soft fabric. Lubrication material should be organic. Never use petroleum based lubricants. Superlit advises soft soap or paraffin to be used as a lubricant under standard conditions.

Amount of lubricant can be determined from the below table:

| Pipe diameter | Approximate Lubricant Amount (For each connection) |
|----------------|---|
| 200 - 600 mm | 0.2 kg |
| 700 - 1200 mm | 0.4 kg |
| 1300 - 2000 mm | 0.6 kg |
| 2000 mm & up | 0.8 kg |

Table 7: Lubricant amount



For easier assembly of pipes, a pit should be excavated for the coupling to settle. After assembly of the pipe to the previous pipe, coupling pit should be filled with backfill material and should be compacted.

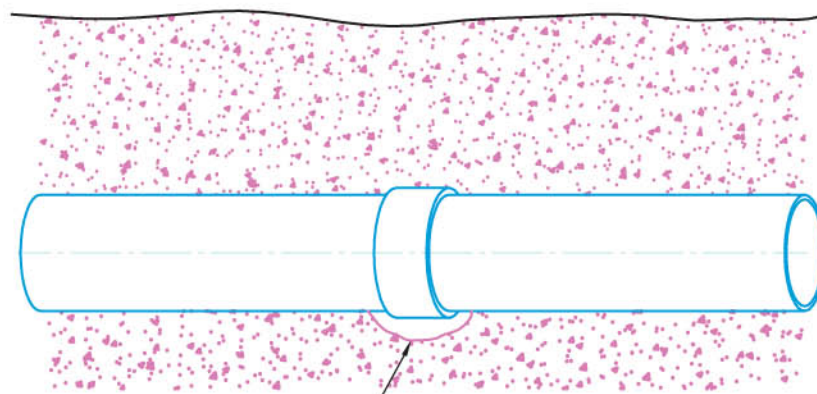

Bell Hole (fill after completing pipe joint)

a) Proper Bedding Support

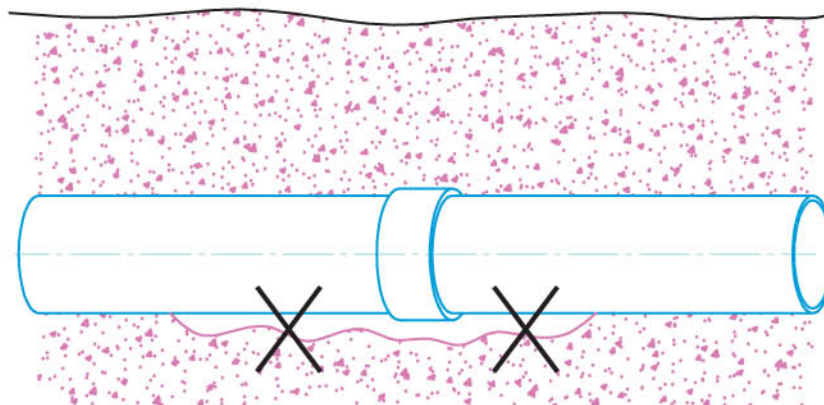

b) Improper Bedding Support

Figure 10 : Coupling pit



Pipes and fittings can be assembled by using below techniques:

a) With come-along jack:

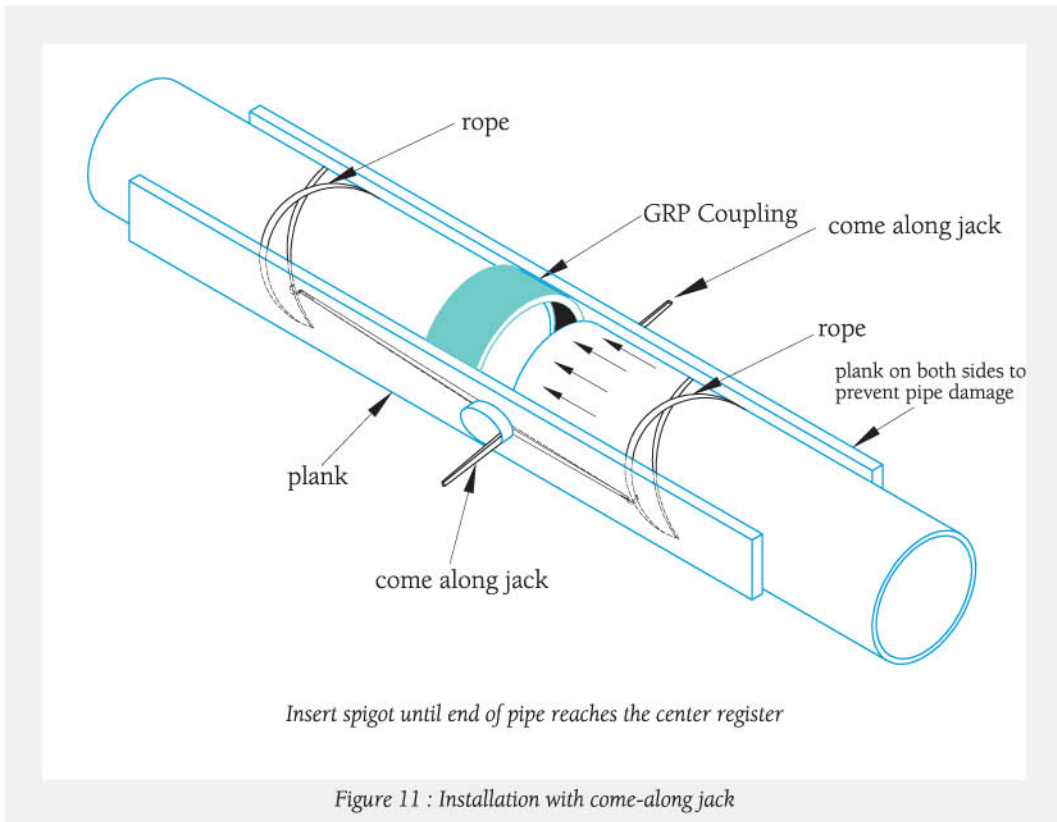



b) With backhoe or bulldozer:

While pushing pipe with backhoe bucket or bulldozer blade, a plywood should be used between the pipe end and the bucket (or the blade) to prevent structural damage on the pipe end.

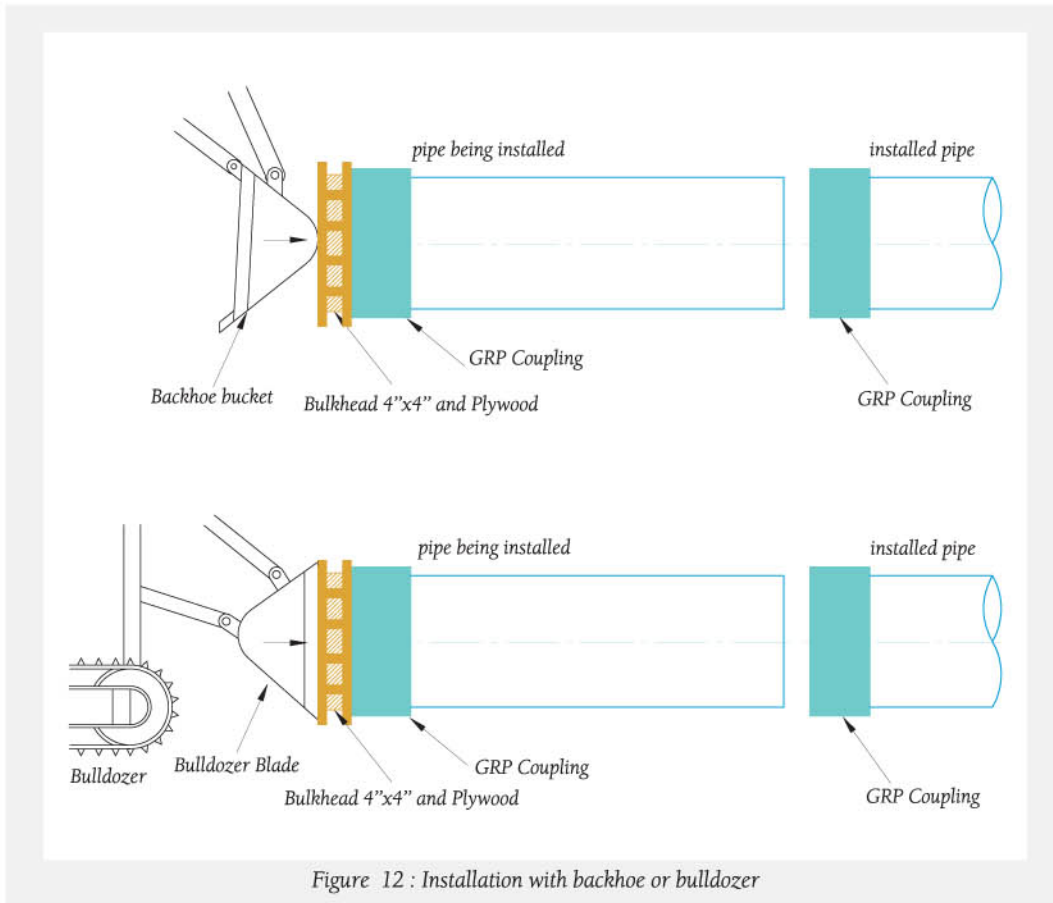

c) With pliable strap and excavator arm.

This method is widely used at jobsites. Pliable strap is tied around the pipe and excavator arm pulls the strap (and strap pulls the pipe) towards the installation direction. This method should only be applied by very experienced excavator operators.



INSTALLATION OF PIPES AND FITTINGS

In all above mentioned methods, pipe should be inserted into the coupling until pipe touches the stopper of the coupling. For big diameter pipes, field technicians can enter the pipe after the installation to control the alignment of the stopper and the pipe. However, for small diameter pipes, a different technique should be used to ensure touching of the pipe and the stopper, since there is no possibility to get into the pipe. In such cases, distance from coupling outer end to the stopper is measured and marked on the pipe, and pipe is pushed inside the coupling until marked section meets the coupling end.

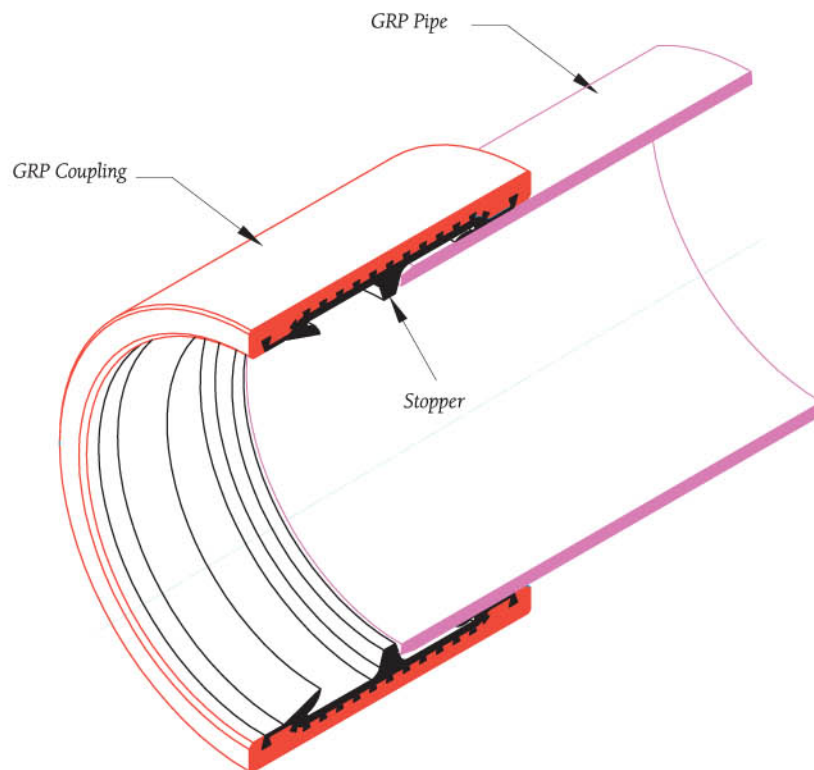

Figure 13 : Coupling section



INSTALLATION OF PIPES AND FITTINGS

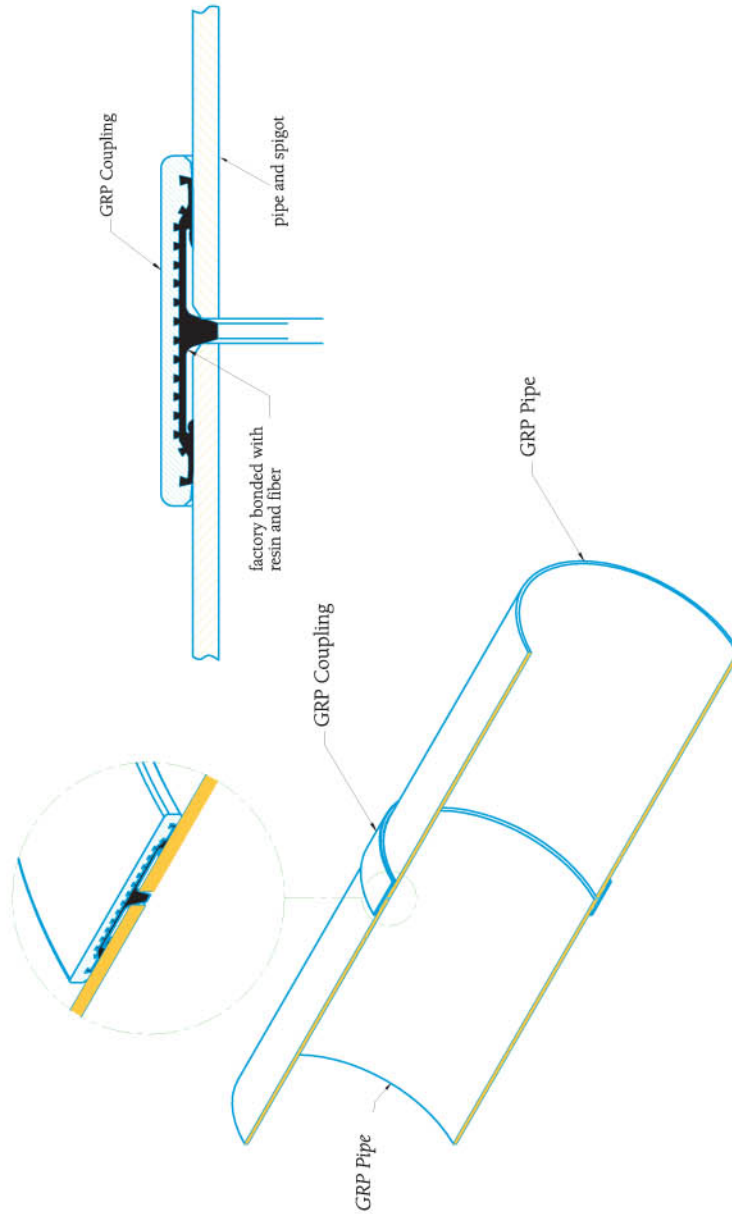

Figure 14 : GRP Pipe - coupling connection detail



5.4 – ANGULAR DEFLECTION

SUPERLIT GRP couplings are manufactured with full face EPDM gaskets. When compared with similar couplings, SUPERLIT GRP couplings guarantee a complete leak tightness. The biggest advantage of these couplings is their suitability for angular deflection. Especially for longer pipelines, it is possible to rotate the pipeline with angular deflection from the couplings, without any necessity for additional elbows. Below are the maximum allowable deflection values.

| Diameter (mm) | Angular deflection (degrees) |
|------------------|---------------------------------|
| 200 - 350 | 3 |
| 400 - 500 | 3 |
| 600 - 900 | 2 |
| 1000 - 1800 | 1 |
| ≥ 1800 | 0.5 |

Table 8: Allowable angular deflection values





Before applying an angular deflection, pipe should be installed to the pipeline at a straight position, then angular deflection should be performed.

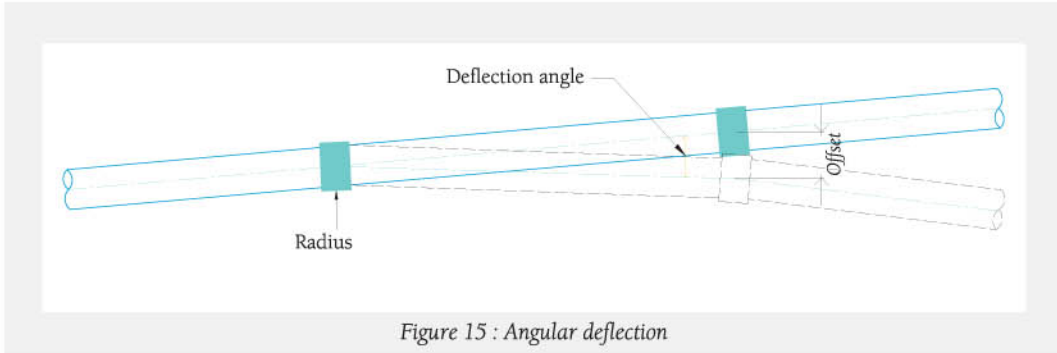

5.5 – FLANGED JOINTS

Flanged connections are used at several conditions such as;

- ④ Vane and pump connections,
- ④ At transitions between different types of pipes (such as connection of a steel pipe with a GRP pipe),
- ④ At water tank or manhole connections.

While connecting two flanges, alignment of bolts is a very important issue to avoid loading bending stress on bolts. Flange thicknesses should be taken into consideration to determine the size of the bolts, nuts and washers. For tightening torques, please consult SUPERLIT engineering teams.





5.6 – FITTING CONNECTIONS

One of the most important advantages of SUPERLIT GRP pipe systems is the possibility of manufacturing project-specific custom designed fittings. However, fittings are the most critical components of the pipelines due to the forces which occurs on fittings. If not stated otherwise, all SUPERLIT fittings should be encased in concrete. Casting of concrete should be performed step by step and by forming layers.

Fittings and pipes should be prevented from floating during concrete casting. Amount of the concrete to be casted should be calculated according to the project specifications.





INSTALLATION OF PIPES AND FITTINGS

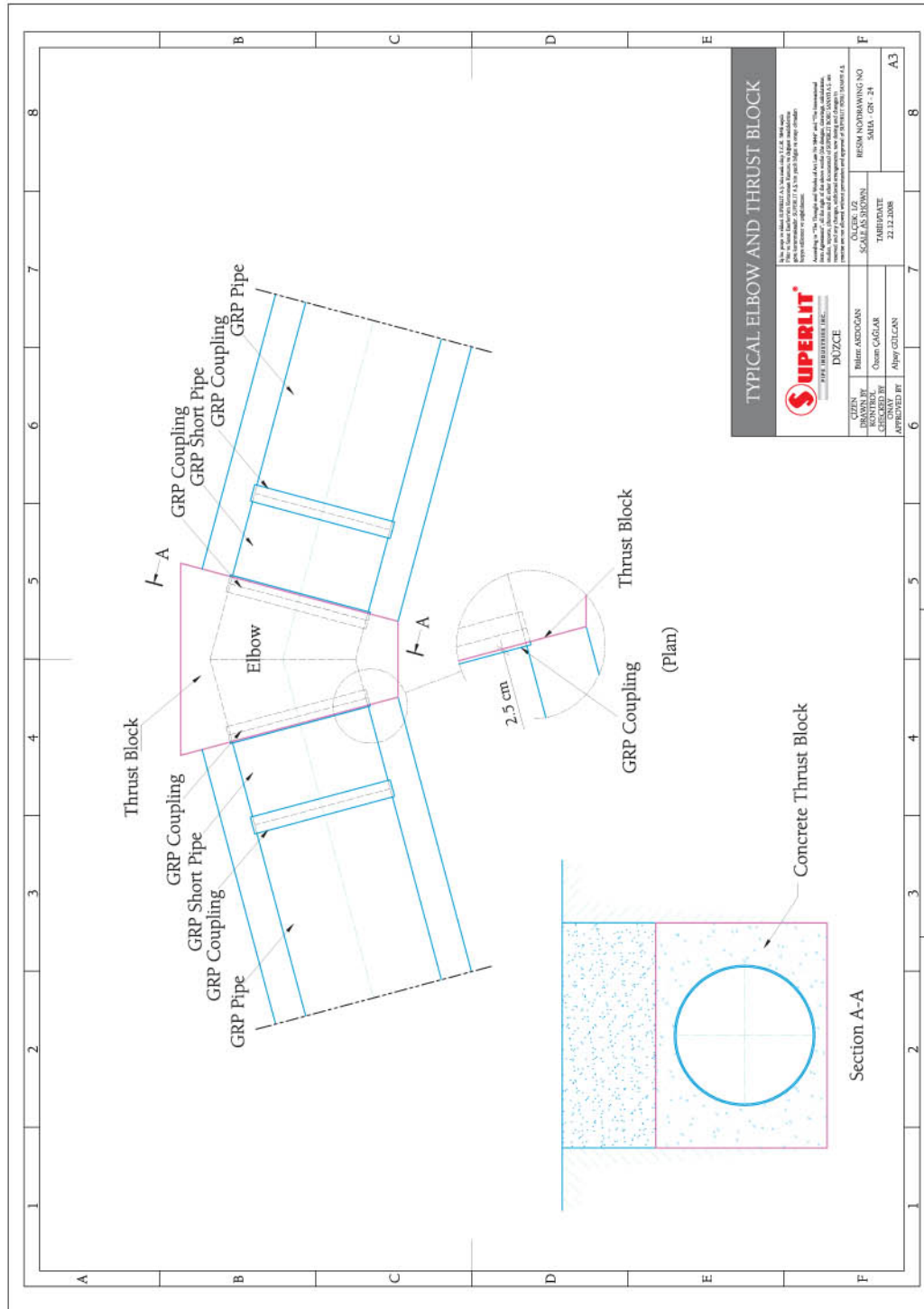

TYPICAL ELBOW AND THRUST BLOCK

SUPERLIT
PIPE INDUSTRIES INC.

DUZCE

| | | | |
|-------------|----------------|-------------------------|-----------------|
| DESIGNED BY | OLCAK, LZ | RESIN MANUFACTURING NO. | A3 |
| DRAWN BY | BAKIR ARSOĞAN | SKOLP AS SHOWN | SAMA - GRP - 21 |
| CHECKED BY | ÖZDEMİR, ER | TARİH/DİJİTAL | |
| APPROVED BY | Alpay ÇELİKCAN | 23.12.2008 | |

The pipe is made in SUPERLIT AS factory in Duzce, Turkey.
The pipe is made in SUPERLIT AS factory in Duzce, Turkey.
The pipe is made in SUPERLIT AS factory in Duzce, Turkey.
The pipe is made in SUPERLIT AS factory in Duzce, Turkey.
The pipe is made in SUPERLIT AS factory in Duzce, Turkey.
The pipe is made in SUPERLIT AS factory in Duzce, Turkey.
The pipe is made in SUPERLIT AS factory in Duzce, Turkey.
The pipe is made in SUPERLIT AS factory in Duzce, Turkey.
The pipe is made in SUPERLIT AS factory in Duzce, Turkey.
The pipe is made in SUPERLIT AS factory in Duzce, Turkey.

Figure 16: Elbow



INSTALLATION OF PIPES AND FITTINGS

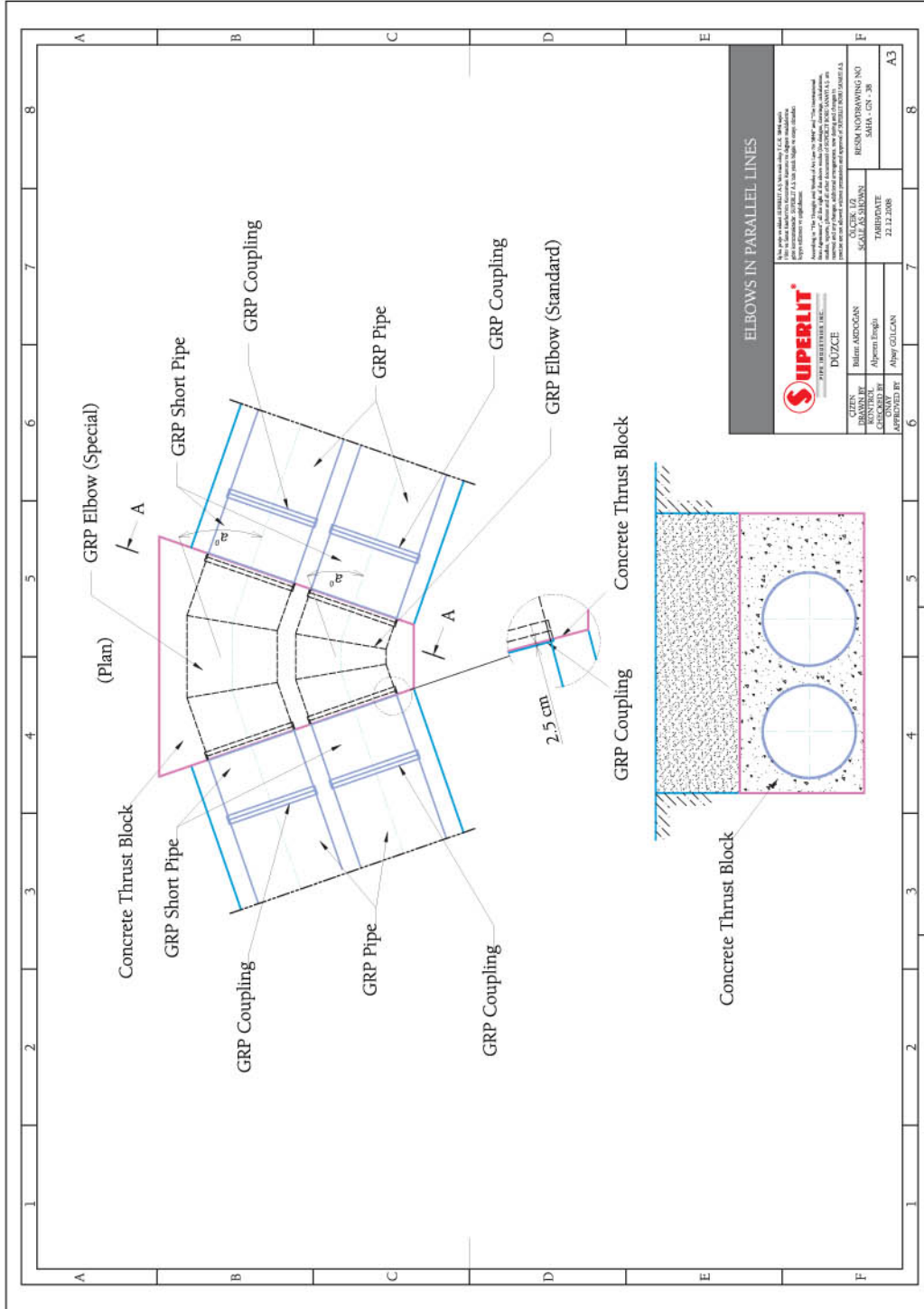

Figure 18: Elbows in parallel lines



INSTALLATION OF PIPES AND FITTINGS

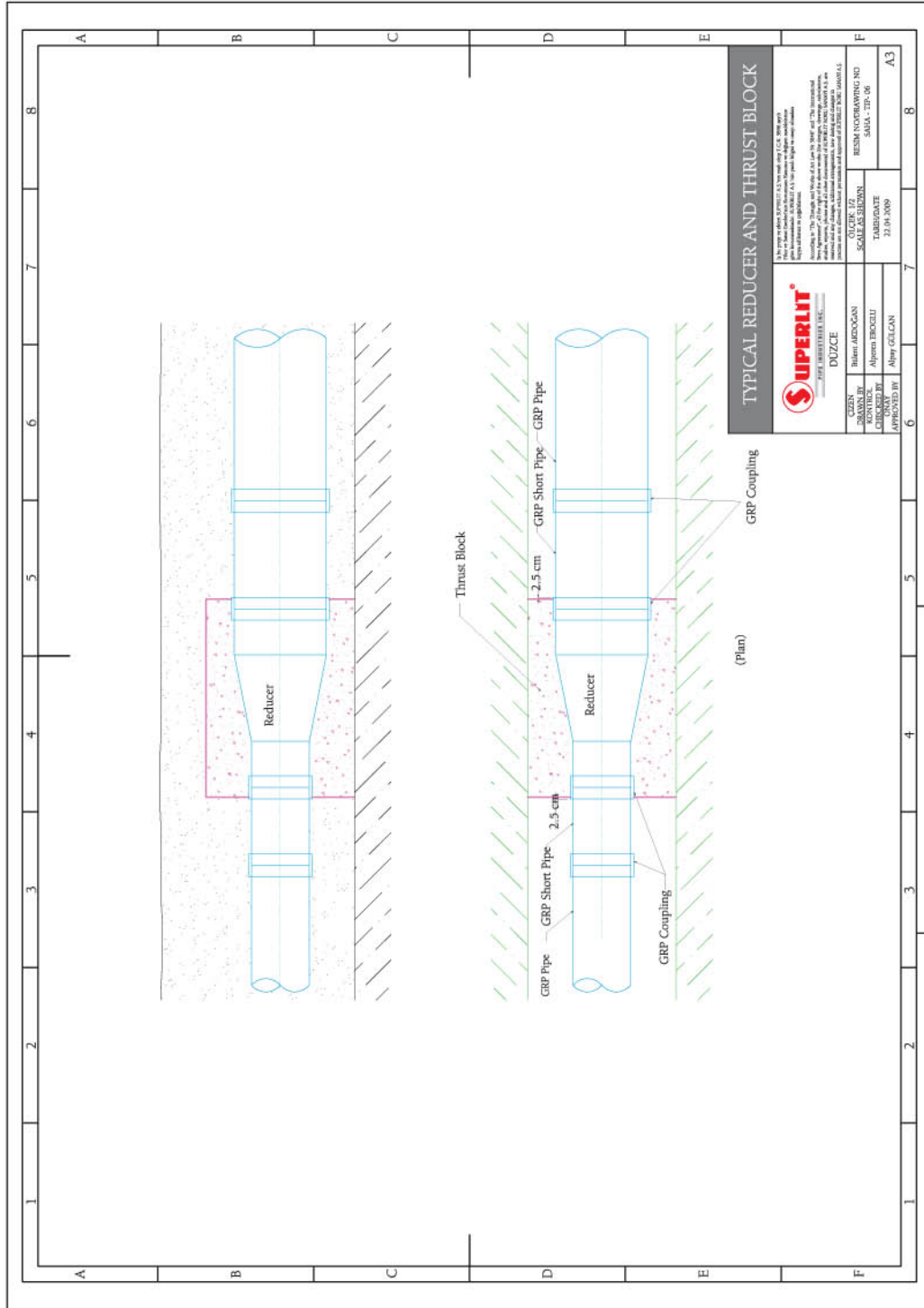

Figure 19: Reducer



5.7 – TRENCHING SLOPES

If the slope of the trench ground is 15 degrees or higher, GRP pipes should be manufactured with ribs. In such trenches, it is not suitable to use rounded gravels for bedding and backfilling, since rounded gravels are subject to washout which leads to pipe support to reduce. Advise of SUPERLIT for bedding and backfilling material in sloped trenches is crushed rocks with internal friction angle 42 degrees.

The most critical issue regarding sloped pipelines is the risk of backfilling and final backfilling erosion. Therefore, erosion risk should be taken into account while determining the backfill material and compaction level. Erosion is a result of strong underground water flows, rain, wind and dust storms. In any of these conditions, granular backfilling material should be resistant to erosion. In some cases, methods such as rip-rap (big rock pieces) placing, claying, asphalt application can be performed.





INSTALLATION OF PIPES AND FITTINGS

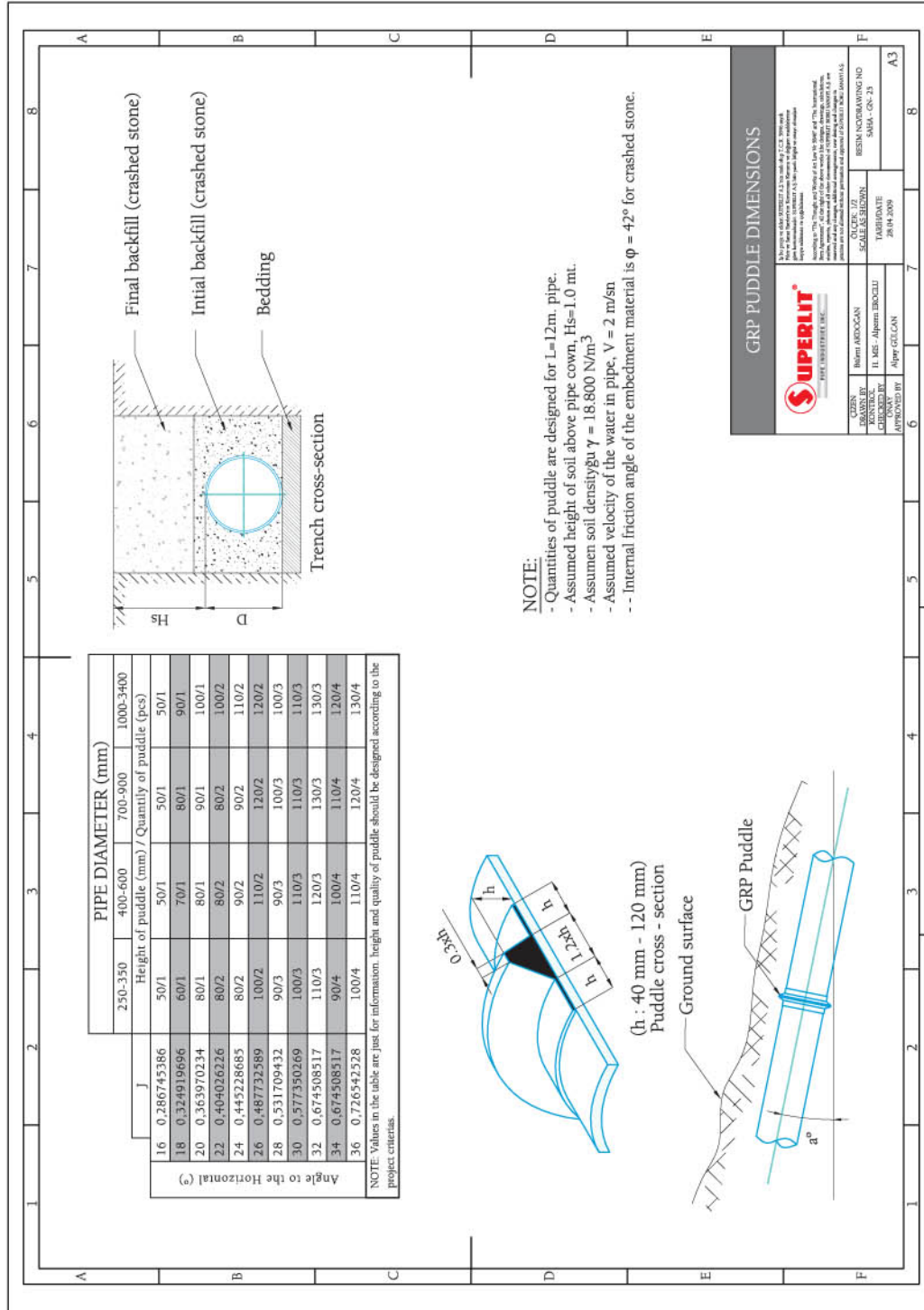

Figure 20: GRP Puddle dimensions



CONNECTION OF PIPES WITH RIGID STRUCTURES

The most important issue regarding pipe and rigid structure connection is the bending stress that may develop when there is a differential settlement (movement) between the pipe and the rigid structure. To manage or at least to lower this bending stress, short pipes should be used especially at connections with manholes, vanes and pumps. There are 2 general methods used:

- a) Coupling should be casted into the rigid structure. (Coupling should be positioned inside the rigid structure model while casting the concrete)
- b) A short pipe wrapped with rubber sealing should be used at connections with the rigid structure to minimize the transition effect. (Rubber sealing should be placed before concrete casting with a recess of 25 mm)

Note: While casting concrete, ensure that the coupling keeps its original shape (roundness). Otherwise, pipe might not slide into the coupling. Use a high stiffness pipe at connections with rigid structures. Ensure that pipe is not subject to high deflections.

Short pipe length can be determined as $2 \times DN$ with an upper limit of 2 meters or as $1 \times DN$ with an upper limit of 1 meter. Make sure that bedding and backfill of the short pipe is compacted properly.

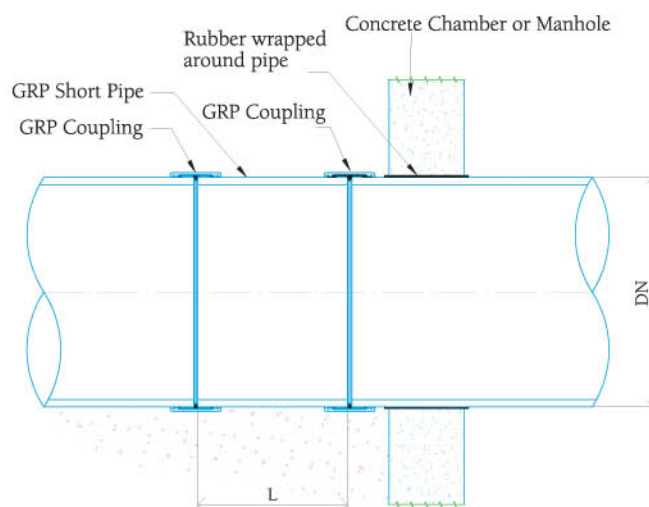

Figure 21 : Short pipe connection



6.0

CONNECTION OF PIPES WITH RIGID STRUCTURES

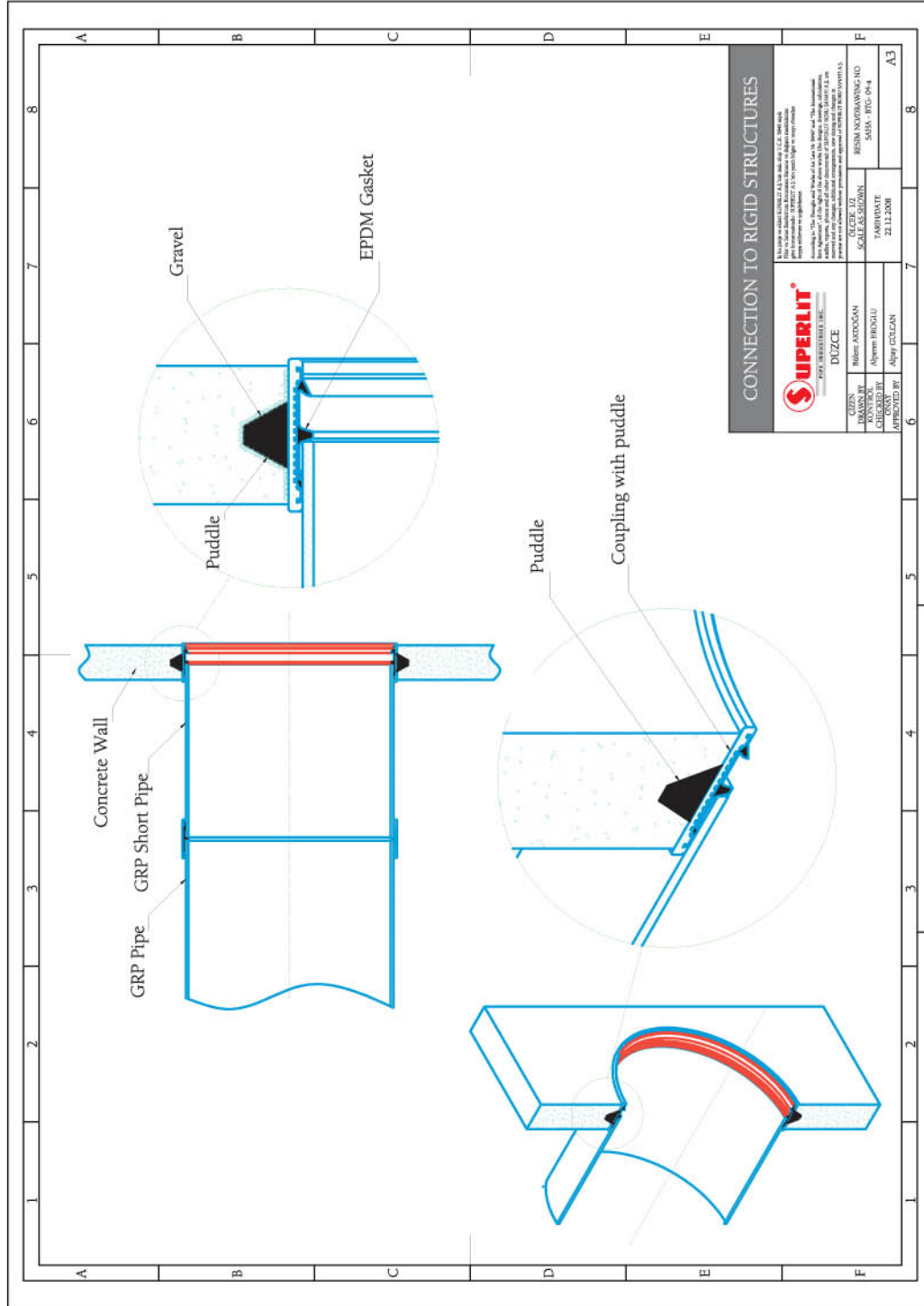

Figure 22: Connection to rigid structures



6.1 – REPAIR/PIPELINE CLOSURE PIPES

Repair and pipeline closure pipes are used under below conditions:

- a) Field hydrotesting is generally applied at certain pipeline lengths, sections. To install testing caps to the section ends, gaps are left along the pipeline. Pipeline closure pipes are used to close these gaps after field hydrotesting.
- b) For faster installation, in some cases, installation starts from both ends of the pipeline route. At the junction point, pipeline closure pipes are used to close the pipeline.
- c) Defective sections of a pipeline can be detected during field hydrotesting. In some cases, these detected parts are needed to be replaced if there is no possibility to repair the crack with hand lamination. In such cases, repair closure pipes are used to close the pipeline.

Before placing the repair / closure pipe, it should be controlled whether or not both sides of the pipeline are at the same level and axis. After cutting repair/closure pipe at the required length, mechanical couplings should be assembled on both ends. When repair / closure pipe is placed in the gap, pipe should be aligned to be on the same level and axis with both pipeline ends. (For a more effective connection, repair / closure pipe length is advised to be 20 mm shorter than the pipeline gap). After ensuring correct alignment, both mechanical couplings should be pulled over to the pipeline. During pulling over, gasket of the coupling should not bend. When coupling pull over and alignment is completed, bolts of the mechanical couplings should be tightened with a torque wrench at the recommended torque value.

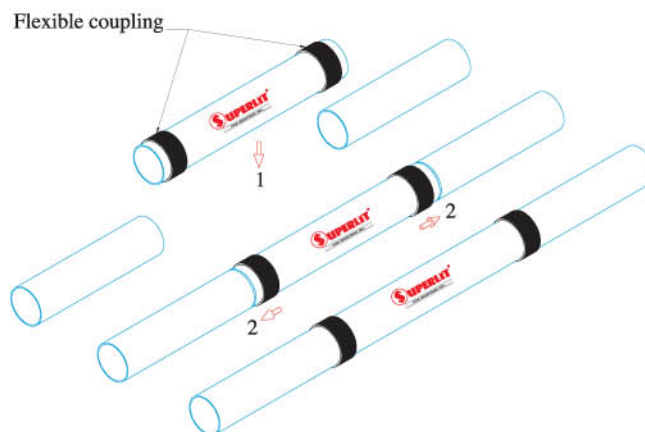

Figure 23: Application of repair/closure pipes



SITE CONTROLS AFTER INSTALLATION

7.1 – CHECKING VERTICAL DEFLECTION

Initial vertical deflection of pipes should be kept under control to reach allowable long term vertical deflections. Vertical deflection is defined as per the below formula:

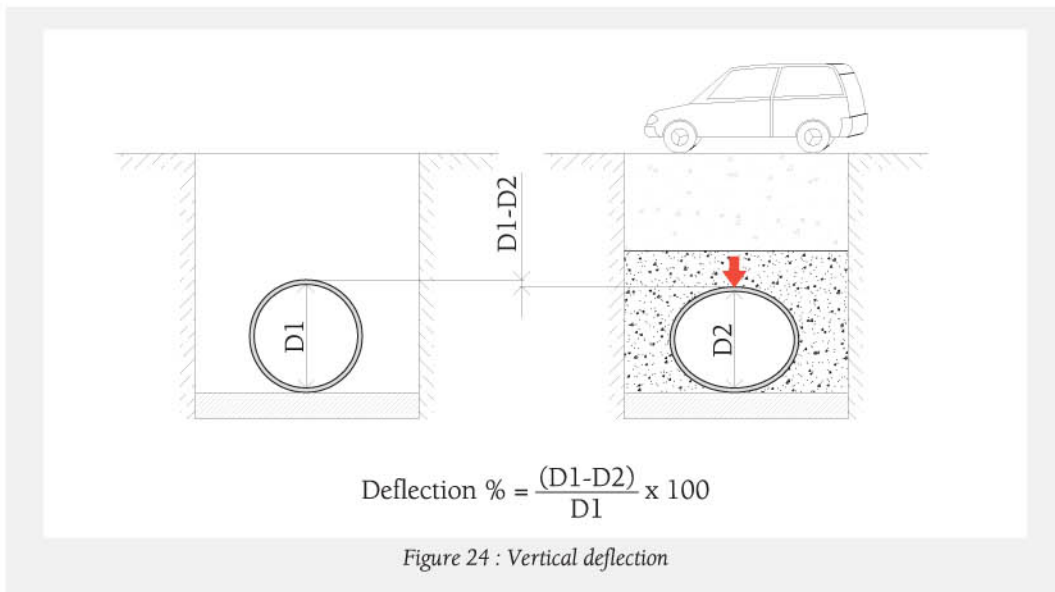

It is rather difficult to measure long term vertical deflections. (Long term deflections generally appear minimum 6 months after the completion of installation and in most cases it is not allowed to stop a pipeline in service to measure deflections). Recommended method is to measure deflections 3 days after completion of backfilling. Deflection controls should be performed parallel to the progress of pipe installation. This way it will be easier to detect a deflection at an initial stage and to take immediate corrective actions.

| | |
|---|--------------|
| Maximum allowable initial deflection | % 2.5 |
| Maximum allowable long term deflection | % 5.0 |

Table 9 : Allowable deflection



7.2 – DETECTING (MEASURING) DEFLECTION

Whenever it is possible for a person to enter a pipeline (which is generally valid for diameters 800 mm and above) vertical internal diameter can be measured with a laser-meter device every 3 meters. For smaller diameters, pig method can be used. Pig is a wooden disc with a height equal to the allowable deflected vertical internal diameter. In this method, pig is pulled through inside the pipeline. If the pig gets in from one end and gets out from the other end without obstruction, vertical deflection is accepted to be within the allowable limits.

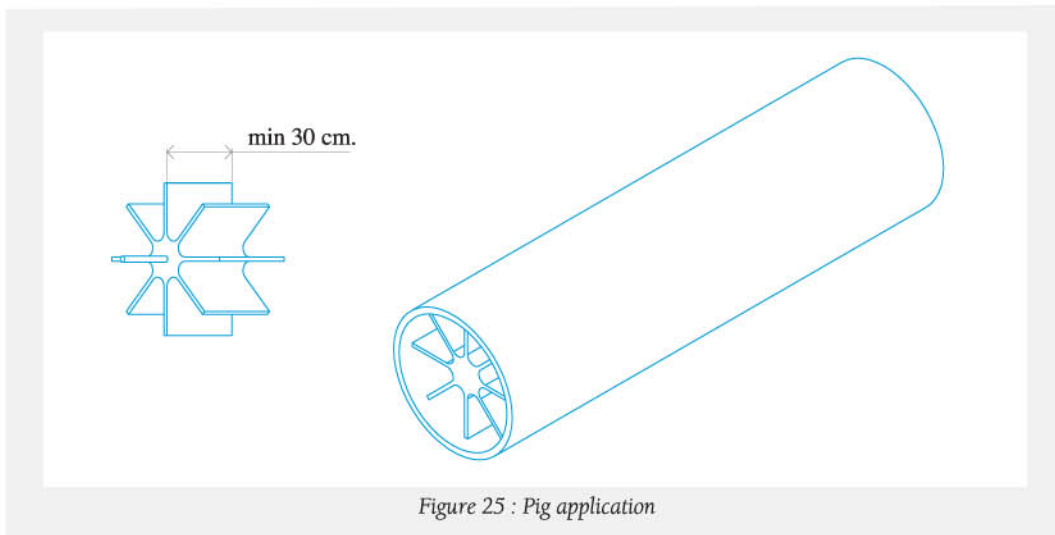

Figure 25 : Pig application

SUPERLIT emphasizes the importance of performing deflection measurements parallel to the installation progress. This way it will be easier to detect a deflection at an initial stage. The cost, as well as the time spent, for corrective actions will be much economical.

Deflection values outside of the allowable limits are generally an outcome of improper backfilling. If an initial deflection out of the allowable limits is detected, backfilling should be excavated, especially bottom sections of the pipe backfilling should be controlled and re-compacted. After ensuring that pipe bottom sections are well compacted, backfilling operation should be repeated.



After this corrective action, deflection measurements should be repeated monthly. After 3 or 4 additional controls, if the vertical deflection stays lower than 5%, corrective action can be considered as successful. If vertical deflection is measured as more than 5% in any of the controls, corrective action should be repeated right from the beginning.

7.3 – FIELD HYDROTESTING

Just like all other types of pipes, GRP pipelines should also be tested before taking the pipeline into operation. Field tests can be performed with water for pressured or non pressured pipelines. The purpose of field hydrotesting is to detect any leakage points through the pipeline.

If the pipeline is tested as a whole, it is rather difficult to detect exact locations of leakages; it is also difficult and costly to fill / unfill the whole pipeline. Therefore, recommended test lengths are 250-1000 meter based on the pipeline conditions.

Below points should be checked before field hydrotesting:

- a) Make sure that all truss blocks and rigid structures made of concrete are completed at least 7 days before the hydrotest. Ensure that concrete of the structures has completed curing and structures are rock solid.
- b) Ensure that all testing equipment are functional and in good condition.
- c) Close and seal the ends of the pipeline section subject to testing with end caps.
- d) Ensure that end caps are supported with anchors to resist test pressure.

For visual inspection of the couplings during hydrotesting, 1/3 of top of the couplings are not backfilled. Safety precautions should be applied around the pipeline, if possible, tested section of the pipeline should be isolated from human access before starting hydrotest. After completion of the hydrotest, unfilled top sections of the couplings should immediately be filled with backfill material.



SITE CONTROLS AFTER INSTALLATION



Note: During hydrotesting of large diameter GRP pipes with nominal pressure 10 bars and above, couplings might rotate. For high pressure pipelines, test pressure should not be increased if the coupling tops are left unfilled for visual inspection. If a coupling rotation is detected, test should be immediately stopped, coupling should be aligned and test should be repeated from the beginning.

7.4 – FILLING THE PIPELINE FOR HYDROTESTING

Pipeline should be filled from the lowest point (level) and air should be expelled from the highest point (level) of the pipeline through air valves. Flow rate of filling should not exceed 5-10% of pipeline nominal design flow rate. If it is not possible to fill the pipeline from the lowest point, additional air valves should be installed.

Below outlined method can be followed:

- ④ Increase the pressure to 2 – 3 bar.
- ④ Keep pipeline under this pressure for 12 hours for stabilization.
- ④ Shut off all air valves after ensuring that all air is expelled from the pipeline.
- ④ After stabilization period, increase pressure by 2 bars every 30 minutes.
- ④ Continue to increase pressure (as explained above) until applied pressure is 1,5 times of the nominal operation pressure of pipeline. (Field hydrotest pressure is defined as the 1,5 times of the nominal operation pipeline pressure)
- ④ Measure test pressure from the lowest point of the pipeline.



7.5- ALLOWABLE LEAKAGE

Most project specifications allow pressure loss or leakage on a pipeline up to a certain limit. According to BS 8010: Part 2.5:1989, allowable leakage in 24 hours is 0.02 liter / mm.

7.6 – TAKING PIPELINE INTO OPERATION

Following points should be considered while taking the pipeline into operation:

- a) Keep filling flow rate at 5-15% of the nominal operational flow rate of the pipeline.
- b) At pressured pipelines, ensure that distance between air valves is around 500-750m.
- c) Air valve diameters should be in accordance with $d/DN = 1/10$ or $1/15$, whereas “d” represents air valve diameter.
- d) Ensure that all air is expelled from the pipeline.
- e) Do not use rapid closing vanes.
- f) To avoid sudden stopping and running of pumps (which causes water hammer), take necessary precautions.
- g) Avoid air penetration from water intake structure into pipeline at gravity pressured pipelines.
- h) When pipeline is discharged partially or completely, repeat the steps mentioned above while re-filling the pipeline.



7.0

SITE CONTROLS AFTER INSTALLATION

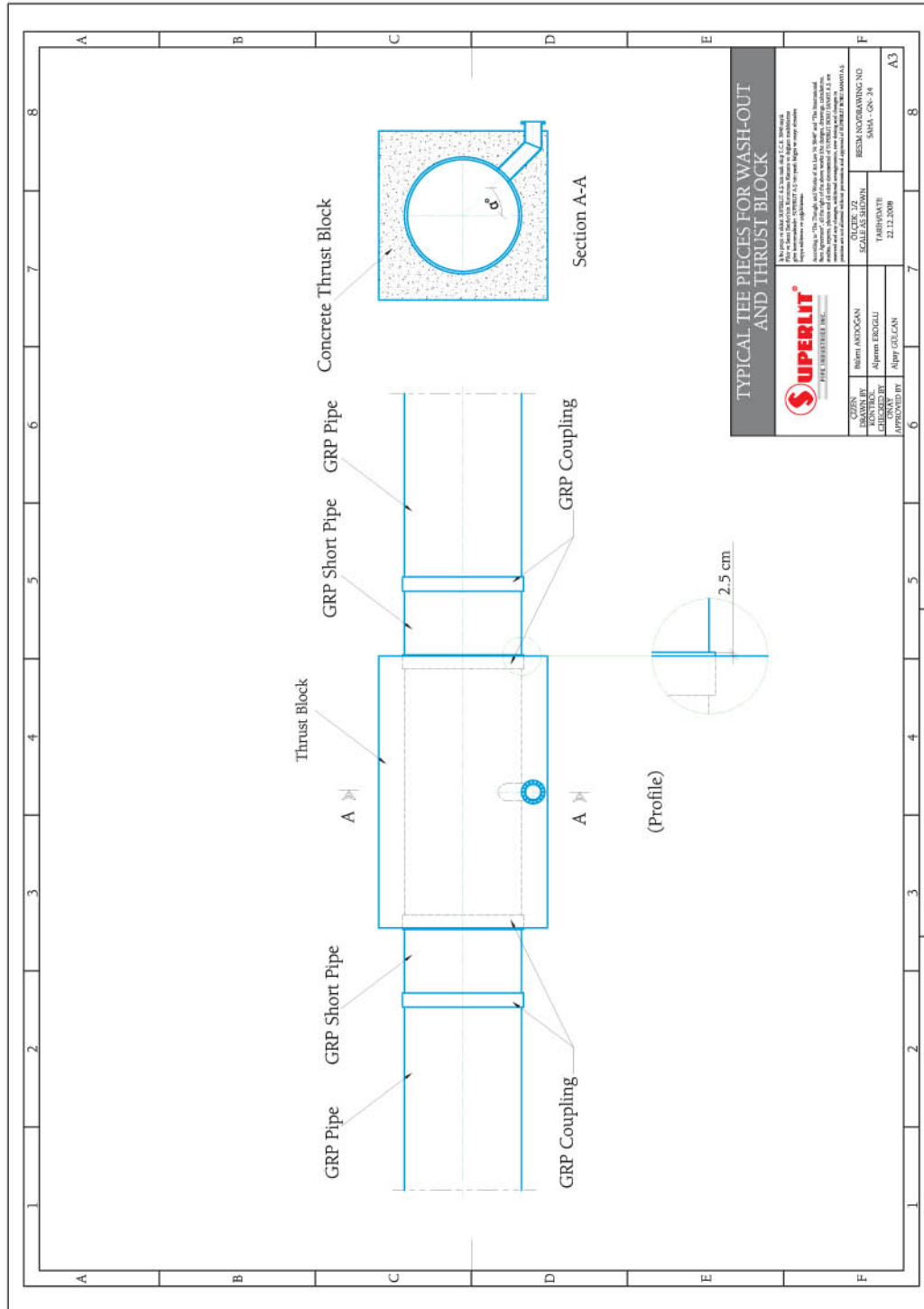

Figure 28: Wash out



SITE CONTROLS AFTER INSTALLATION

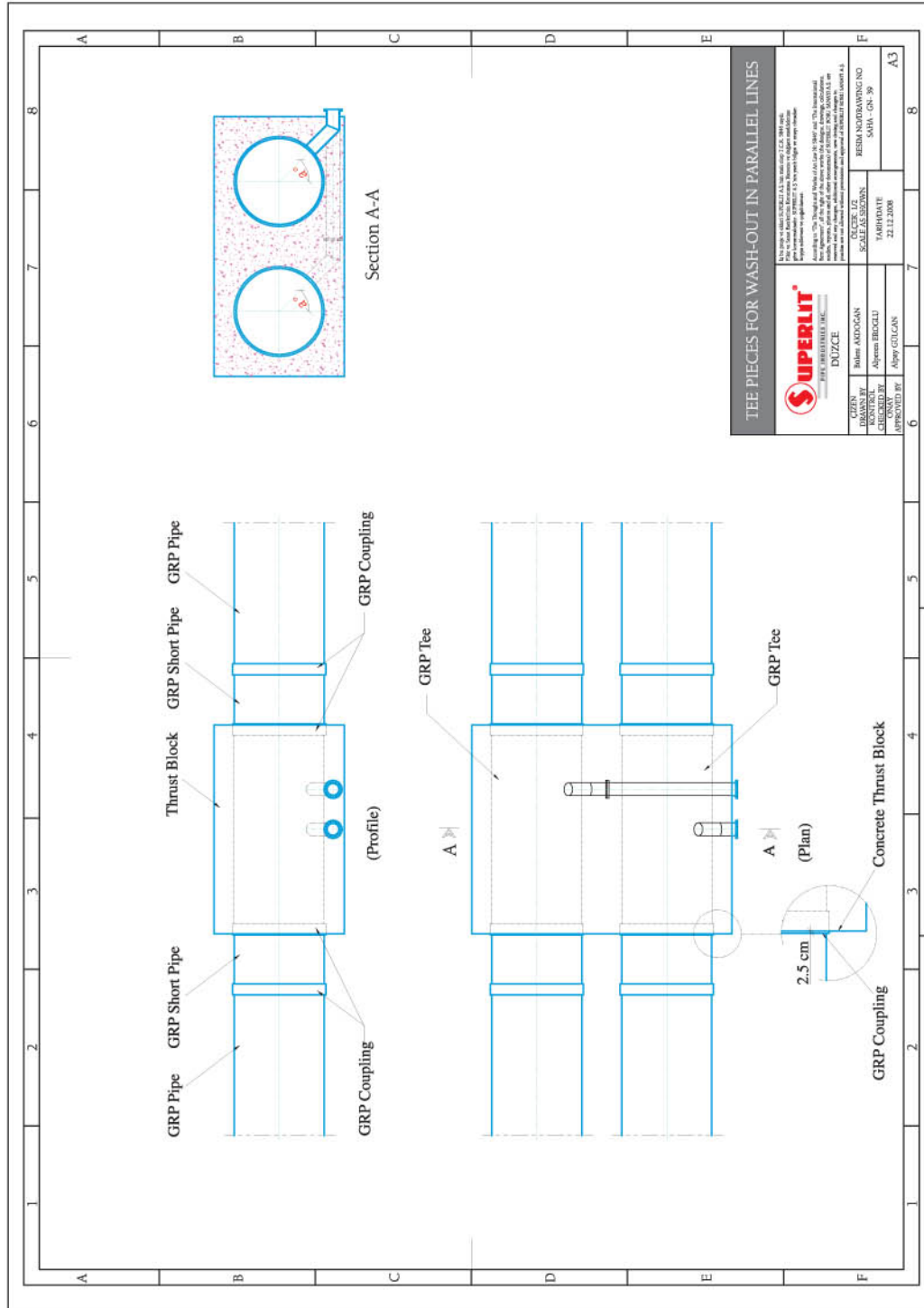

Figure 29: Wash out



SITE CONTROLS AFTER INSTALLATION

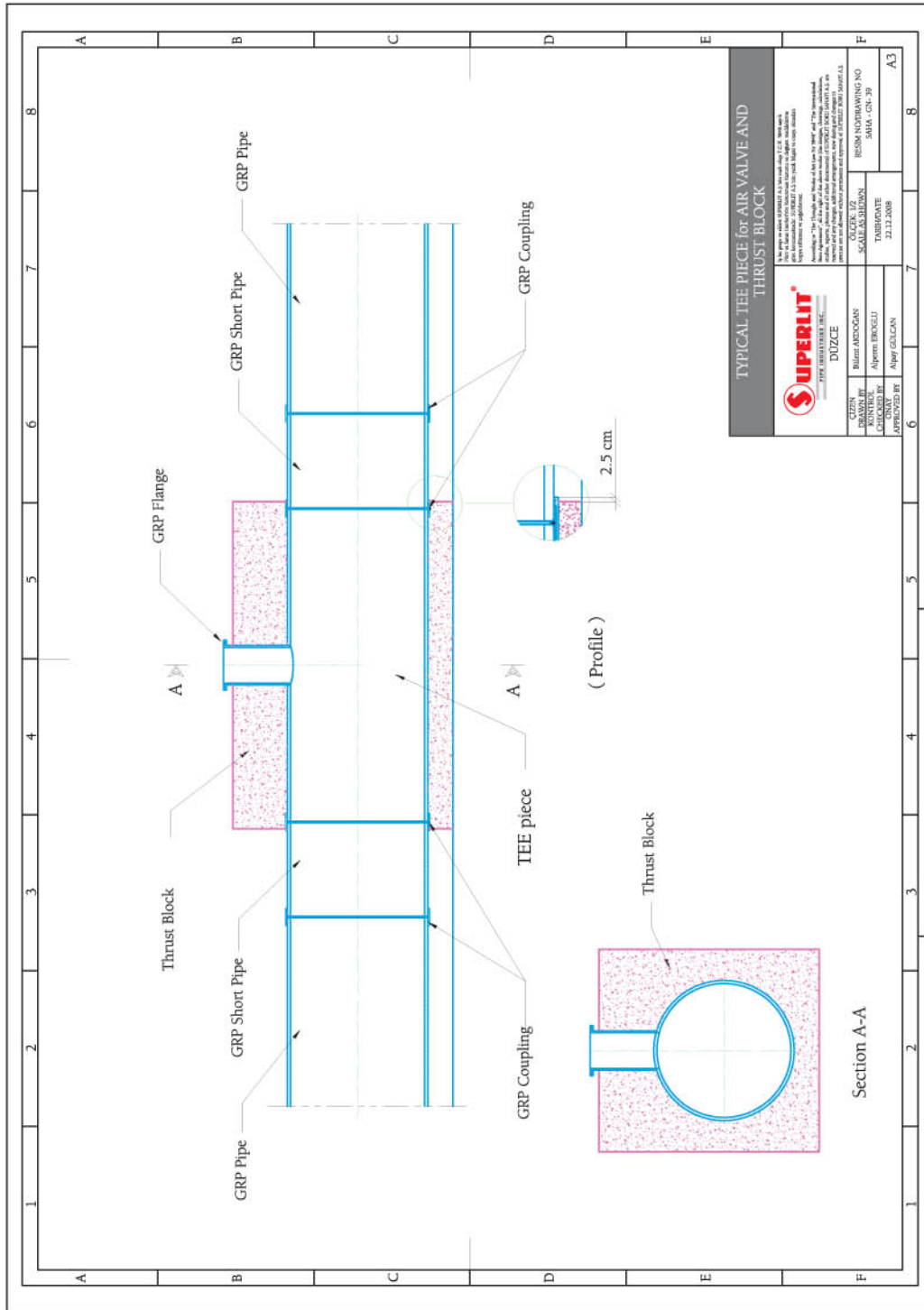

Figure 28: Air valve



JOB SITE SAFETY PROCEDURES

8.1 – PRE-INSTALLATION STAGE

- a) All site personnel should complete technical and safety trainings regarding job site activities including loading, unloading, storing and installation before accessing to the job site.
- b) “Job Site Safety Procedures” booklet should be prepared and distributed to all job site personnel. Warning labels and plates should be placed at appropriate locations at job site.
- c) During safety trainings, prior accidents and experiences should be presented by pictures and videos, undesired outcomes of the accidents should be emphasized.

It is vital to persuade and convince job site personnel for the importance of job site safety to be able to enforce and apply the procedures strictly.

- d) A safety supervisor should be assigned. Responsibilities, duties and authority of the safety supervisor should be clearly identified and declared to all job site personnel.
- e) Safety equipment such as helmets, safety shoes, safety gloves, etc should be provided and consigned to each site personnel with a signed receipt declaration.
- f) Site personnel should strictly be controlled in terms of utilization of the safety equipment.
- g) Safety equipment supplied should be quality certified by independent accredited agencies.
- h) Periodic maintenance and controls on safety equipments should be performed. Old, torn out or non-functional equipment should be replaced.
- i) Personnel who do not obey and apply Job Site Safety Procedures should immediately be discharged from the jobsite area and pre-determined penalties should be exercised.



8.2 – INSTALLATION STAGE

- a) Safety supervisor should strictly control whether or not installation activities are performed as described during installation trainings. If there is a case which needs application of a non-standard installation procedure, such a procedure should only be applied under the permission and supervision of the Safety Supervisor.
- b) Installation equipment should be free of damage and defects, and should be completely functional.
- c) Machines and vehicles such as excavator, bulldozer, grader, etc should only be operated by certified and licensed operators without any exception.
- d) Make sure that communication system among job site personnel is clear, correct, uninterrupted and not subject to misunderstanding or misinterpretation.

(For instance, communication of a worker inside the trench, with the crane operator lowering a pipe into the trench)

8.3 – WHILE ENTERING INTO A PIPELINE

While entering into a pipeline for control or repair purposes, below items should be taken into consideration:

- a) Entrance into a pipeline should only be done with Safety Supervisor's permission. Safety Supervisor should evaluate all potential risks before permitting entrance. Personnel having health problems and personnel who are not willing should not be allowed or forced to enter into a pipeline.
- b) If there is a necessity to perform gas and oxygen level tests, such tests should be performed by authorized and certified personnel.
- c) If the oxygen level inside the pipeline is not sufficient, entering personnel should be equipped with oxygen tubes.
- d) Personnel entering into a pipeline should be equipped with safety equipments and should always have a spare lighting.
- e) Communication between entering team and outside team should be clear and uninterrupted. For any reason if communication is lost, inside team should immediately get out of the pipeline.



8.4 – DURING REPAIRS AT JOB SITE

- a) Safety procedures exercised during installation should also be applied while removing a pipe or a fitting from an installed pipeline.

- b) Repairing works should be performed at a repairing station. Boundaries of the repairing station should be clearly marked.

- c) Any person other than authorized repair personnel should not enter to the repair station.

- d) Repairing equipment should be functional, in good condition, clean and clear of defects.

- e) Safety Supervisor should continuously inspect utilization of safety equipment during repairing.

- f) Repair station environment should be clear of any possible fire risks.

- g) Repair station should be equipped with fire extinguishers.

If the repair should be performed inside the pipeline:

- h) Repairing personnel entering into the pipeline should wear isolated work suits and gas masks. If the oxygen level is not sufficient, personnel should be equipped with oxygen tubes. Sufficient ventilation should be supplied to remove dust from the pipeline.

- i) If the repair inside the pipe should be done at 2 meter height or more, suitable scaffolding should be provided.



8.5 – STORAGE OF CHEMICALS AND RAW MATERIALS

- a) Chemicals and raw materials which will be used for repairs should be stored in a closed and locked storage room.

- b) Storage room should have natural ventilation and should not be subject to high temperatures.

- c) Storage room should be isolated from outer side conditions such as humidity, rain, snow, etc.

- d) All chemicals and raw materials should be stored at their original packages.

- e) Storage room should be equipped with fire extinguishers.