



Envistar®

A flexible range of air handling units with integrated control equipment



Envistar® Top



Envistar® Compact



Envistar® Flex



Air handling with focus on LCC

We have been conserving the Earth's **resources** for more than fifty years

Copenhagen Airport, Harpa Concert Hall in Reykjavik, sports arenas, schools, offices, hospitals, shopping centres and homes in a number of countries all have low energy consumption thanks to IV Produkt. IV Produkt has been involved in a long list of projects. With energy-efficient air handling units, we make it possible to recover energy, increase property value and conserve the Earth's resources.

IV Produkt is a privately-owned company based in Växjö in the Swedish county of Småland that develops and manufactures innovative solutions for air handling. We have been doing this since 1969.

Today, we are the market leader and have the fastest development rate in the industry. Quick turnaround times make us efficient, and the way in which we take responsibility makes it both safe and easy for you as a customer.

Energy efficiency and environmental concerns have been part of our business concept since 1991, prompting us to focus on the life cycle cost, LCC. In other words, the total cost of purchasing,



Development, production and head office in Växjö.

operation, service and environmental impact. We want this cost to be as low as possible and regard it as a natural aspect of our product development. We are ISO certified under 9001 and 14001, which we consider essential.

Our products and many years of experience enable us to identify innovative solutions for air handling which are perfect for your particular project. We will gladly help you personally to achieve our common goal of protecting the Earth's resources.



Eurovent Certification is a certification body which verifies the performance of air handling units in accordance with European and international standards. It allows products from different manufacturers to be compared on equal terms.

Our Envistar and Flexomix air handling units have been tested by Eurovent in accordance with EN 1886 and EN 13053. When performance calculations carry the above mark, you can be sure they have been certified by Eurovent Certification.

The total **solution** that meets your needs

The Envistar range consists of the Envistar Top, Envistar Compact and Envistar Flex models. These are innovative unit-based solutions that provide high flexibility at the right price. The whole range has integrated control equipment. The units have been

developed with consideration to the market's need for low installation and operating costs. The Envistar range can be used in all types of property, e.g. schools, offices, hotels, shopping centres, industrial premises and hospitals.



We have developed Home Concept for blocks of flats, which is specially adapted for energy-efficient homes. Read more about Envistar Home Concept in the separate brochure.

Envistar®

+ High-efficiency fans and motors

+ High-efficiency heat recovery units

+ Can be controlled and monitored using the IV Produkt AHU Controls app or using the IV Produkt Cloud cloud service



+ Casing with optimum U value

+ ThermoCooler HP integrated **cooling/heating pump** with stepless control/regulation of cooling and heating power

Envistar®

Envistar® Top

A top-connected duct connection is best suited in approx. 70 percent of systems with air flow ranges up to 2.0 m³/s. Envistar Top saves up to 75 percent of floor space compared to a traditional installation. This makes Envistar Top the most economic and energy-efficient solution for the available floor space. The Envistar Top series has been adapted to allow transport in through narrow door openings and tight passages.

- 7 sizes
- Air flow 0.10–2.00 m³/s
- Can be controlled and monitored using the IV Produkt AHU Controls app or using the IV Produkt Cloud service
- The EcoCooler cooling unit with cooling recovery in combination with rotor. Stepless control/regulation of the cooling power via a frequency inverter
- **new!** ThermoCooler HP integrated reversible heat pump with stepless control of cooling and heating power
- Energy recovery unit – rotor or counter-flow exchanger
- Fans with high-efficiency EC motors
- Folded bag filters
- Mixing extract/recirculating unit as an option



Supplied as module in sections in the sizes 09, 12, 16 and 21.

Flow ranges – thermal wheel

- Green bar shows the approved air flow range according to Ecodesign 2018
- The red field indicates the technical maximum flow for the various sizes

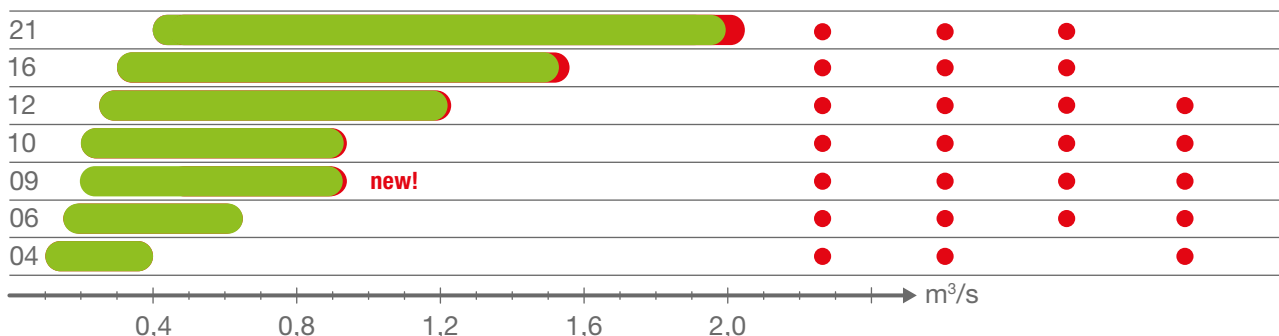

Smart installation approach



Save
20 m²

Connection in the top saves space and money

A top-connected unit on each floor means a major saving when it comes to floor space compared to an installation where a larger gable-connected unit supplies the entire building with air. In this example, the total saving is 66 percent.

When the ducts are connected in the top, the unit can be positioned directly behind doors. When the doors are open, the surface in front of the unit functions as a service area. This either means that more lettable space is created or that

the construction cost is lowered. The total installation cost for this project is also lower compared to a gable-connected installation.

With cooling unit EcoCooler or reversible heat pump ThermoCooler HP integrated into the unit, roof space is freed up that can be used for a nice terrace with endless possibilities. The property becomes more attractive, space is freed up, the value increases and the rental income increases.



A fan room measuring 30 m² is required for a gable-connected unit, while the corresponding surface area for the three top-connected units is as small as 10 m².

Envistar® Top

More and more customers are choosing a unit with a counter-flow exchanger from our Home Concept. This type of energy recovery unit is also available with our top connected unit. These units are not only suitable for homes, but also for other projects. One of the greatest advantages is that the air flow streams are separated.

The unit is available as a single unit or in sections. For some projects, the passage to the fan room can be tight, which is when using sections can be a good approach.

- 5 sizes: 04, 06, 09, 10 and 12
- Air flow 0.13–1.15 m³/s
- High-efficiency heat recovery unit that can achieve a dry temperature efficiency of 85 percent



- Unique patented defrosting technology – Optimised Defrosting System (ODS) – which ensures the highest possible annual efficiency
- No risk of odour transfer

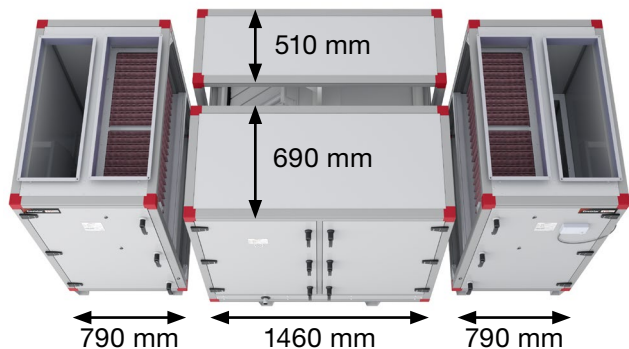

Envistar Top size 12 with split counter-flow exchanger.

We want to make day-to-day life easier for the installer

Our ambition is to develop our units according to requests from users and installers, and we know that it can be complicated and expensive to get the unit into the building. We have therefore created the unique solution of splitting the counter-flow exchanger widthways for Envistar Top in sizes 09 and 12. We hope this will make it easier for you to get the unit into the building, and even into tight lifts.

Envistar[®] Compact

Envistar Compact has extremely compact measurements, which means that it fits perfectly into tight spaces.

The unit can be connected to ducts at the gables or via two of the connections at the top, and is also available in a configuration for installation outdoors.

Envistar Compact offers a simple and cost-efficient installation.



- 4 sizes
- Air flow 0.10–1.50 m³/s
- Can be controlled and monitored using the IV Produkt AHU Controls app or using the IV Produkt Cloud service
- Energy optimisation function – ECO
- StarCooler cooling unit
- Rotary heat exchanger
- Outdoor configuration
- Fans with high-efficiency EC motors
- Deep-folded bag filters



Envistar Compact is available in sizes 04, 06, 10 and 16.

- The green field indicates the approved air flow range according to Ecodesign 2018
- The red field indicates the technical maximum flow for the various sizes

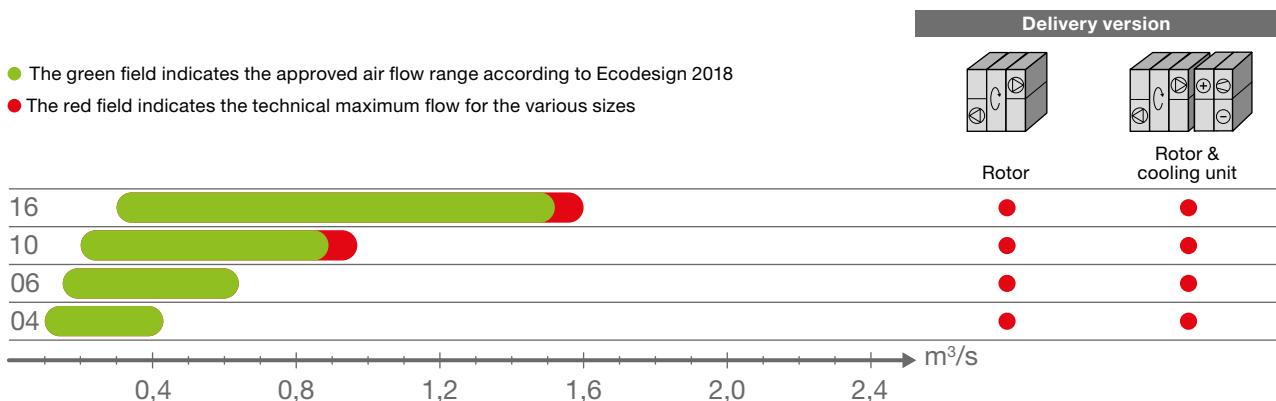

Envistar® Flex

Envistar Flex is available with a wide range of fans, motors and heat recovery units to ensure everything you need for energy-optimised air handling.

The units are designed for comfort ventilation of premises, and are suitable for most types of property, e.g. hospitals, schools, offices, shops and industrial premises.

Envistar Flex can be delivered in sections to facilitate transport. Most modules will fit through a 900 mm-wide opening.



- 15 sizes
- Air flow 0.10–11.5 m³/s
- Can be controlled and monitored using the IV Produkt AHU Controls app or using the IV Produkt Cloud service
- Energy optimisation function – ECO
- Rotary heat exchanger, plate heat exchanger, counter-flow exchanger or coil recovery
- EcoCooler cooling unit, also with cooling recovery. Stepless control of the cooling power via a frequency inverter
- **new!** ThermoCooler HP integrated cooling/heating pump with stepless control/regulation of cooling and heating power
- The fans have PM motors with EC or frequency inverter control
- Mixing section, recirculating unit
- Outdoor configuration



Handles all climates

Envistar Flex can be delivered factory-mounted in genuine outdoor version. The unit is ready to be used, which allows fast and easy installation.

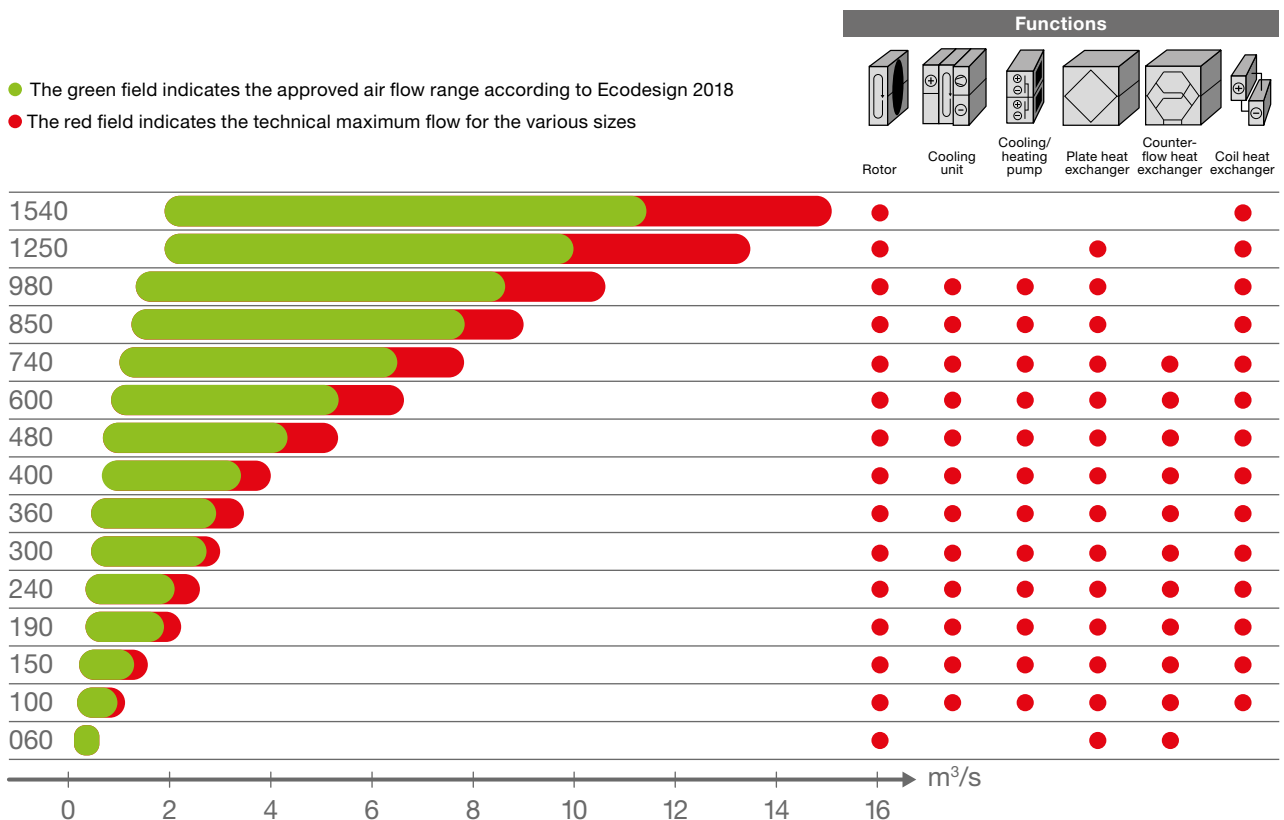

Pleasant indoor climate

The entire Envistar range is available with an integrated cooling unit. As a result, you get a turnkey solution for ventilation and comfort cooling which does not require any outdoor installations.

All the cooling unit's components are built into the air handling unit. You get a complete CE-marked

installation, which is always tested at our test facility. A unit with integrated cooling requires significantly less energy than one with an external cooling unit.

Within the Envistar range, there are two different integrated cooling units: EcoCooler and StarCooler.

EcoCooler

EcoCooler is the optimum integrated cooling unit for Envistar Top and Envistar Flex.

In some buildings, air flow varies greatly, while requirements are strict for accurate control/regulation of the supply air temperature. EcoCooler meets the requirements through stepless control of the cooling power via a frequency inverter.

- Envistar Top with EcoCooler has an air flow of 0.12–2.0 m³/s and a cooling power of 1.6–40 kW
- Envistar Flex with EcoCooler has an air flow of 0.22–8.6 m³/s and a cooling power of 3–210 kW
- High EER (COP), 4–7
- Ideal for large variable air flows, VAV
- Available with cooling recovery
- No outdoor installations
- Short build lengths for simple transport and smaller installation space
- Complete CE-marked cooling installation
- No regulatory requirements on annual inspection for Envistar Top in sizes 04, 06, 09, 10 and 12

Read more about EcoCooler in the separate brochure. Envistar Compact is delivered with the StarCooler cooling unit, which uses capacity regulation.



Envistar Top with EcoCooler.

Stepless control

Cooling power kW

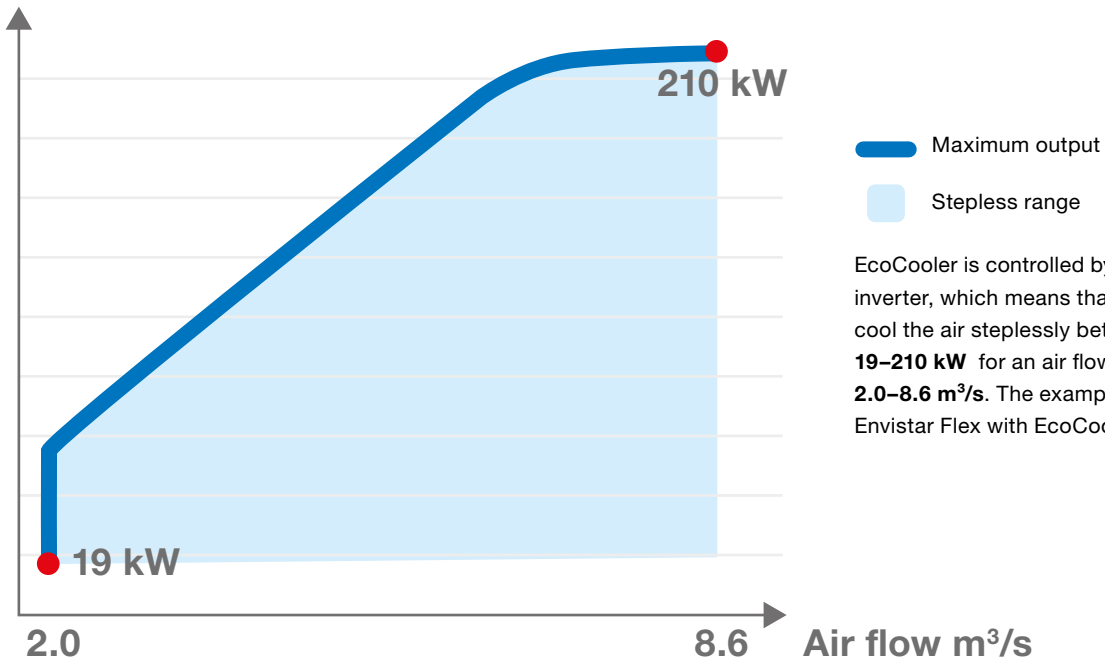

EcoCooler is controlled by the frequency inverter, which means that the unit can cool the air steplessly between **19–210 kW** for an air flow between **2.0–8.6 m³/s**. The example shows Envistar Flex with EcoCooler in size 980.

Cooling recovery

The EcoCooler cooling unit is available with an integrated rotary heat exchanger for cooling recovery in sequence with the cooling unit. This maximises energy utilisation and ensures a low connected power load.

The rotary heat exchanger can be selected in different configurations for optimal energy recovery. The rotors are also available with a hygroscopic surface, further reducing energy use.



On a hot summer's day with an outdoor temperature of 28°C, we can recover sufficient cooling from the extract air to cool the supply air to 23.5°C. In this case, we only need to cool the air by 7.5°C instead of 12°C in order to achieve an inlet temperature of 16°C.

Heat pump & cooling unit in one

The reversible ThermoCooler HP cooling/heating pump can be integrated into Envistar Top and Envistar Flex.

All parts of the cooling/heating pump are incorporated in a module section, which is located in the air handling unit. This means that you receive a total solution for heating ventilation air and comfort cooling in one unit. Since everything is

integrated in the air handling unit, there is no need for heating coils, run-around coils or outdoor cooling installations. The installation is complete, CE-marked and always tested in our test facility before delivery.

A unit with integrated cooling/heating pump is more energy efficient than a traditional cooling installation with external cooling unit and heating coil.

ThermoCooler HP



The scroll compressors have PM motors and are speed controlled. The expansion valves are electronic and the unit dimensions are adapted to facilitate transport into the building.

ThermoCooler HP is the optimal integrated cooling/heating pump for Envistar Flex.

In some buildings, air flow varies greatly, while requirements are strict for accurate control/regulation of the supply air temperature. ThermoCooler HP meets the requirements through stepless control of the cooling and heating power via a frequency inverter.

- Envistar Top with ThermoCooler HP
air flow 0.25–2.0 m³/s, cooling power 3–32 kW
- Envistar Flex with ThermoCooler HP
air flow 0.25–8.60 m³/s, cooling power 3–140 kW
- High EER (COP) up to 6.0
in the cooling application
- High COP (6–15) in the heating mode,
depending on outdoor temperature
- Ideal for large variable air flows (VAV)
- Complete CE-marked cooling and
heating installation

Also sufficient in winter

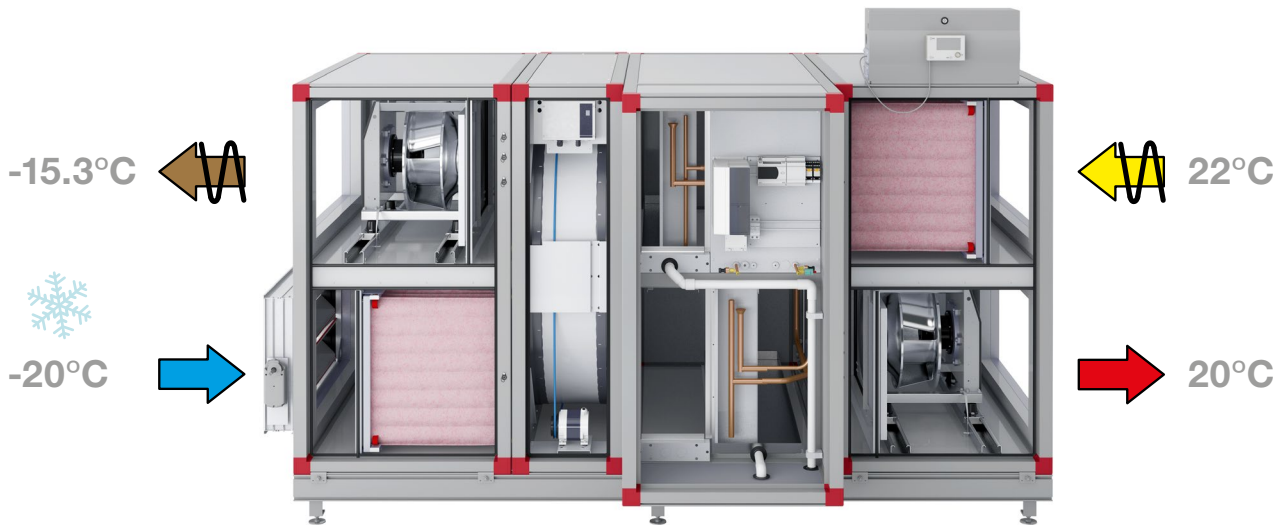

On a cold winter's day ThermoCooler HP can blow in a supply air temperature of 20°C with a return air temperature of 22°C .

ThermoCooler HP can together with the rotor achieve a dry temperature efficiency of over 90 %, excluding the electricity from the compressor.

Auxiliary heating as an option

If the return air temperature becomes colder than the design temperature, or if there is an imbalance in the air flow, auxiliary heating is available as an option. The auxiliary heating gets its power supply via ThermoCooler HP and can be easily mounted retrospectively if necessary. With design outdoor temperatures under -18°C , auxiliary heating is standard.

One of the biggest advantages with ThermoCooler HP is that there is no need for heating coils with outdoor temperatures down to around -20°C . This assumes a return air temperature of at least 22°C .

The IV Produkt Designer program is used to calculate whether a heating coil is needed. The heating coil must always be placed after the supply air fan in the case of design outdoor temperatures below -26°C .

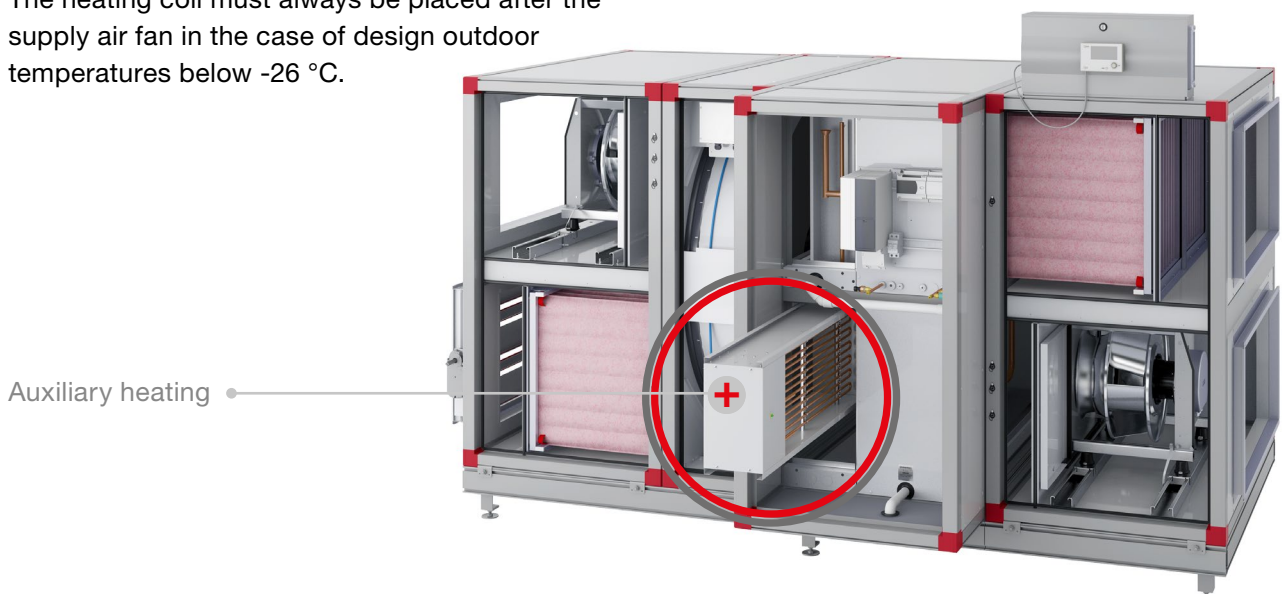

ThermoCooler HP creates many winners

- High reliability
- Long technical life
- No defrost cycle required
- Low installation and operating costs
- Requires no outdoor installations
- Saves floor space



Accuracy in every detail

When we developed ThermoCooler HP, high reliability, long technical life, low operating costs and stepless control of temperature/power were our most important criterias.

After a lot of research, calculations, comprehensive field-testing and accurate measurements in our Innovation Center, we have decided to place the heating/cooling pump's extract air coil before the rotor. This means there is no risk of the coil freezing. Unnecessary defrosting cycles are avoided, as they affect the supply air temperature. The unit therefore has a very high reliability and long technical life.

As a natural part of our product development, we consider how products will be used and transported. That is why we have designed ThermoCooler HP to facilitate transport through narrow passages.

Simple installation

As the whole installation for cooling and additional heating for ventilation is integrated in one unit, there is no need for expensive and large run-around coils or plumbing. The responsibility for the installation lies with the supplier instead of several different parties.

Investment that pays for itself

The installation costs for ThermoCooler HP are considerably lower than a traditional installation. Contrary to a traditional installation, ThermoCooler HP does not require external cooling and heating installations connected to the air handling unit. This can often save more than 30 % of the total installation costs.

The energy use and operating costs for ThermoCooler HP are considerably lower than a traditional installation.



You no longer need expensive outdoor cooling installations



New installation approach with EcoCooler & ThermoCooler HP

As EcoCooler and ThermoCooler HP are integrated in the air handling unit, there is no need for an outdoor cooling machine and dry coolers.

In many places there is a lack of both land and building space, which means higher prices. The EcoCooler cooling unit or ThermoCooler HP

cooling/heating pump free up space on the roof creating a fifth facade. The roof surface can be used as a pleasant terrace with endless possibilities. The property becomes more attractive, space is freed up, the value increases and the rental income increases.

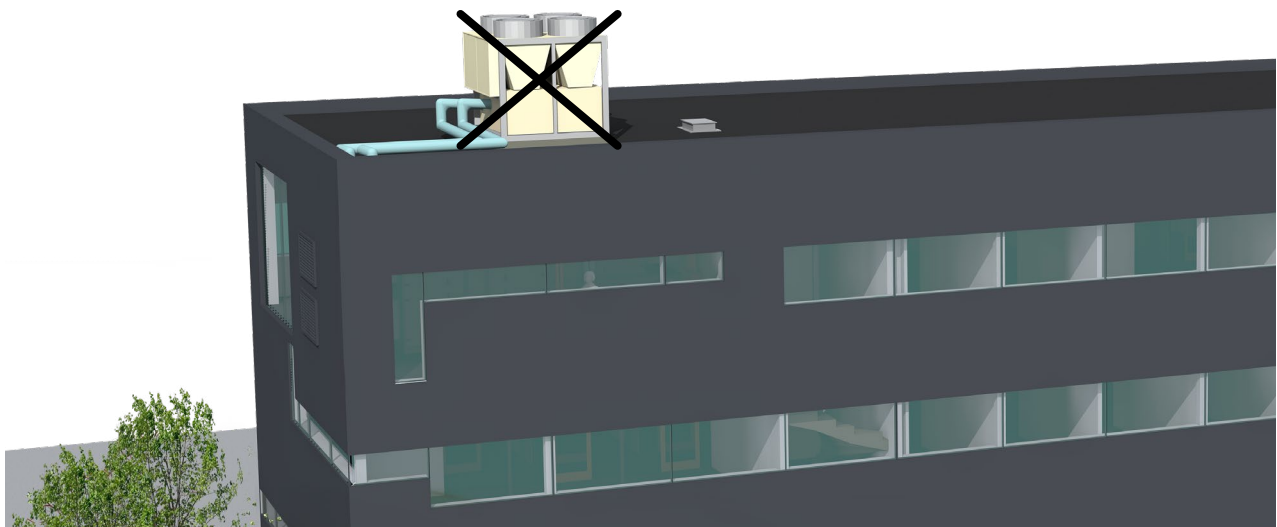

Did you know that...

operating costs for the EcoCooler or ThermoCooler HP to cool a 300 m² office building are only 1000 – 1500 kWh/year due to climate and operating time

We conserve resources

Air that is extracted via ventilation systems often contains a lot of heat. We do not want to let this heat go to waste and aim to recover as much of it as possible. We do this by using various types of heat exchangers. We recover the heat from the extract air

and use it to pre-heat the cold air from outside. There are several different types of high-efficiency heat recovery units in the Envistar range. This allows us to offer the best solution at the same time as conserving the Earth's resources.

Heat recovery

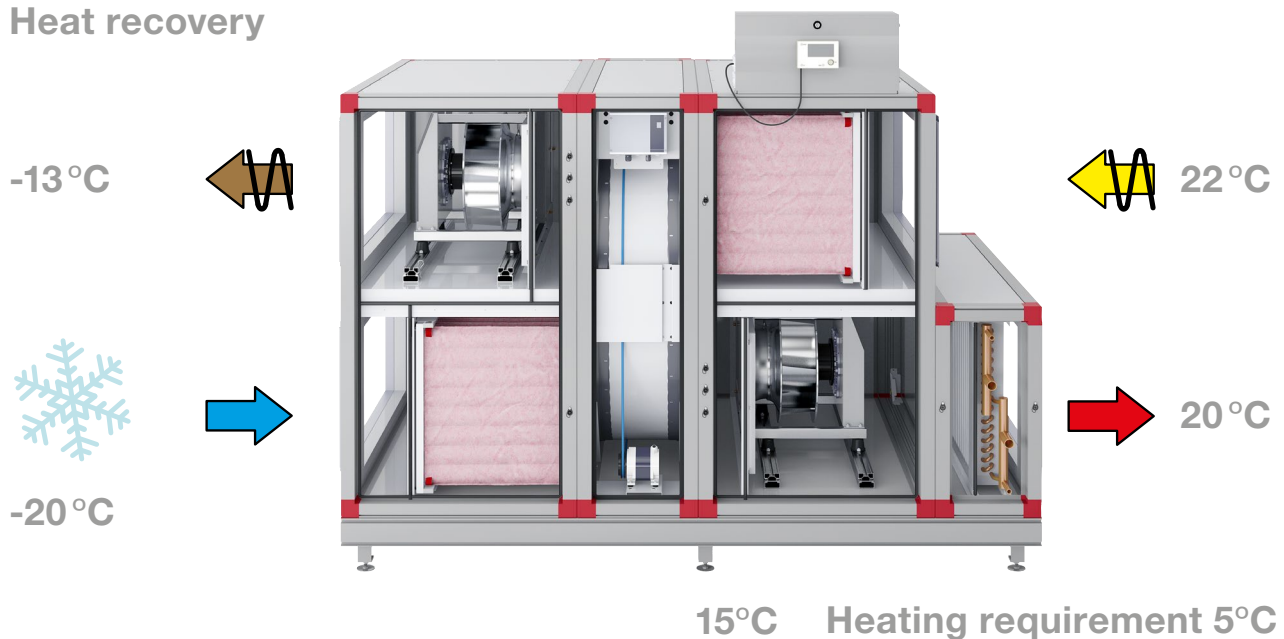

On a cold winter's day with an outdoor temperature of -20°C , we can recover sufficient heat from the extract air to heat the supply air to 15°C using a rotary heat exchanger. In this case, we only need to heat the air by 5°C instead of 40°C in order to achieve an inlet temperature of 20°C .



Rotary heat exchanger

- High-efficiency heat recovery unit with a dry temperature efficiency of up to 87 %
- For each unit size, there are different power variants of rotor to optimise heat recovery and life cycle costs
- Available with hygroscopic surface for improved cooling recovery

Counter-flow exchanger

- High-efficiency heat recovery unit that can achieve a dry temperature efficiency of 85 percent
- Patented defrosting technology – ODS
- No risk of odour transfer
- Also available for Envistar Home Concept, which is specially adapted for block of flats



Coil recovery

- To optimise the energy recovery process, many different configurations are available
- No risk of odour transfer



Plate heat exchanger

- A complete unit which uses heat recovery according to the air-air principle
- Available in various configurations for optimal efficiency
- No risk of odour transfer



Efficiency

In the industry, the performance of heat recovery units is presented in different ways. For example, we might talk about dry and wet temperature efficiency.

According to the EN 308 standard, dry efficiency should be reported. This method is used to avoid giving a misleadingly high performance by incorrectly utilising the air humidity.

Top performance

The Envistar range is available with a wide range of high-efficiency fans and motors in order to optimise efficiency of the fans and minimise electricity consumption. Each fan impeller and

motor is balanced and test-run together to guarantee function, ensuring a long technical life. To allow easy servicing, the fan package is mounted on rails, making it easy to pull out.

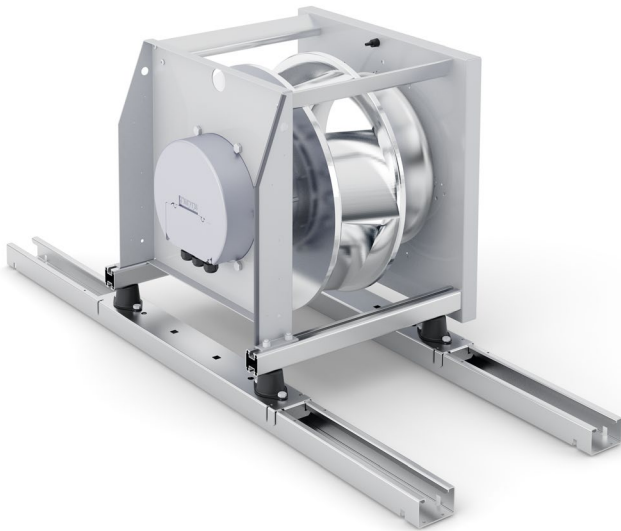

Fans with PM motors and EC control

Available for Envistar Top, Envistar Compact and Envistar Flex in sizes 060–980.

- Rotating diffuser and airfoil blades
- Aluminium/composite fan impeller
- For Envistar Flex, single and dual fans can be supplied for optimal performance
- Permanent magnet motor, efficiency class equivalent to IE4
- Each unit size is available with various fans and motors in order to optimise efficiency and reduce electricity consumption, i.e. optimise to the lowest possible specific fan power value (SFPv)

Fans with PM-motors and integrated frequency inverters

Available for Envistar Flex in the sizes 480–1540.

- Fan impeller with rotating diffuser and airfoil blades, which provide a higher fan efficiency
- Epoxy-coated steel impellers
- Can be supplied with single and dual fans for optimal performance
- Permanent magnet motors with speed control, efficiency class equivalent to IE4
- Each unit size is available with various fans and motors in order to optimise efficiency and reduce electricity consumption, i.e. optimise to the lowest possible specific fan power value (SFPv)

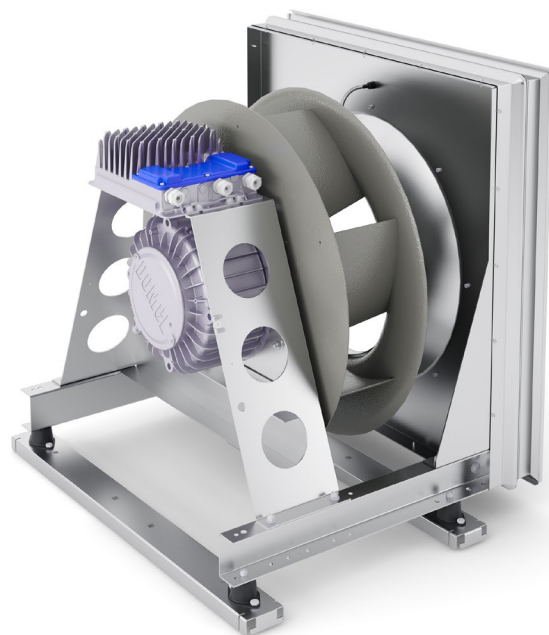

Casing gives added **benefits**

Thanks to our rapid pace of development, we are continually getting better at energy-optimised air handling.

As a result of product development, the entire range has a casing with optimum energy performance and design.

We have worked on innovative solutions throughout the entire manufacturing process, enabling us to offer AHUs with minimised heat losses through the casing. According to the EN 1886 standard, the classification of the casing is determined by the U value. The lower the number, the better the insulation capacity.

ThermoLine

Two configurations of the casing are available. The standard version is classified under casing class T3, which has a U value of 1.24*. For the best energy performance, you can now also choose ThermoLine, which is a class T2 casing and has a U value of 0.88*.

A casing class of T2 reduces cold bridges. In fan rooms with high air humidity, this reduces the risk of condensation forming on the unit casing.

Class T2: U value 0.5–1.0
Class T3: U value 1.0–1.4

Indoor AHUs

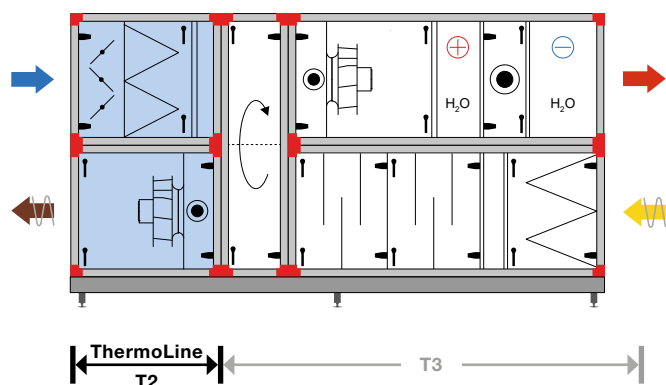

A major advantage of the casing design is that we can choose different casing classes for selected parts of the unit. For example, we can select the inlet and exhaust air sections for a **ThermoLine – T2** indoor unit to offer the most energy-efficient and cost-effective solution.

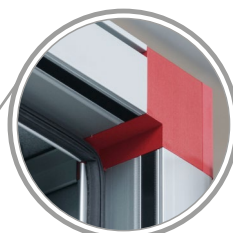

The black plastic insert in the profile breaks the cold bridge and is a characteristic of the **ThermoLine – T2** casing.

Outdoor AHUs

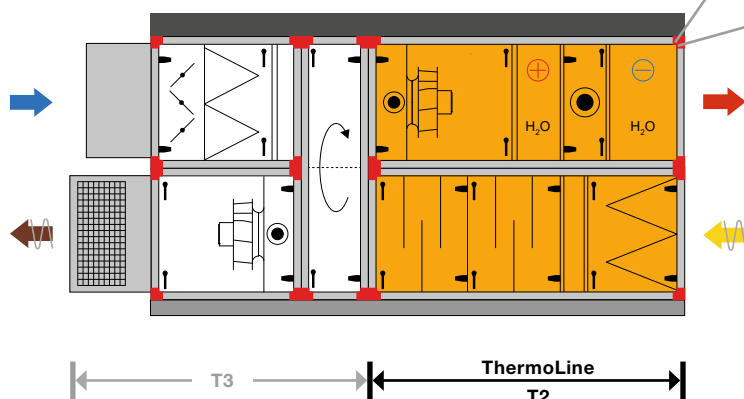

In the case of outdoor air handling units, the supply and extract air sections are the primary cause of heat losses. Using **ThermoLine – T2** for these sections offers the most energy-efficient and cost-effective solution.

The pay-back period for ThermoLine depends on the installation's operating conditions and energy prices.

* Measured by Eurovent in model box in accordance with EN 1886.

Hygienic design **simplifies** cleaning and maintenance



Hygienic design according to VDI 6022 means, among other things:

- extended options for inspection of all unit components
- easier cleaning of units, fans, heat exchangers and coils
- drip trays under cooling coils have inclines towards drains
- high requirements for material selection for gaskets, seals and attachments
- extended requirements for technical and operating information.

Hygienic design for air handling unit according to VDI 6022 places specific requirements on the duct system and operation and maintenance.

When ordering the unit in hygienic design, the instructions and other documentation are included according to the requirements in VDI 6022.

Customised material



The standard material for both internal and external doors and panels is alu-zink in corrosion class C4.

Certain environments require a higher corrosion class. In which case it is possible to have a stainless steel or painted interior. Certain fittings are also available in a painted or stainless steel configuration.

The architecture requires, among other things, that the colour matches the colouring of the building. In which case there is an option for a painted exterior.

Control communication with endless possibilities

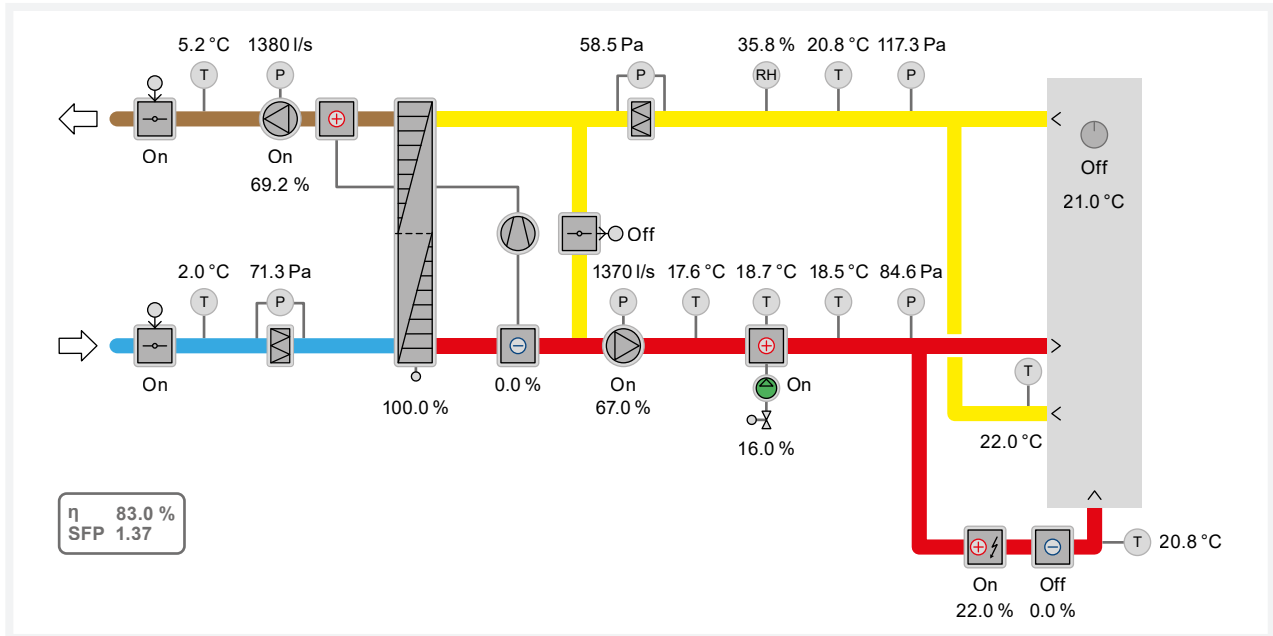

When you order a unit from the Envistar range, you receive a complete air handling unit that has been function-tested and is ready to be commissioned. We are continuously developing the software and adding new smart features, enabling the lowest energy use and the best indoor climate. The functions can be adapted as required and

some examples of application are zone control, various fire functions and dew point control. The unit is supplied with project-specific wiring and control diagrams, and a handset that allows you to optimise flows and temperatures. A hand-held terminal with touchscreen is now available as an optional extra.

BMS

Building Management System

ModBus BACnet LON OPC



Cloud service



SMS



Web



Textweb



App for smart units



Hand-held terminal



Hand-held terminal with touchscreen

Gives you full **control** – wherever you are

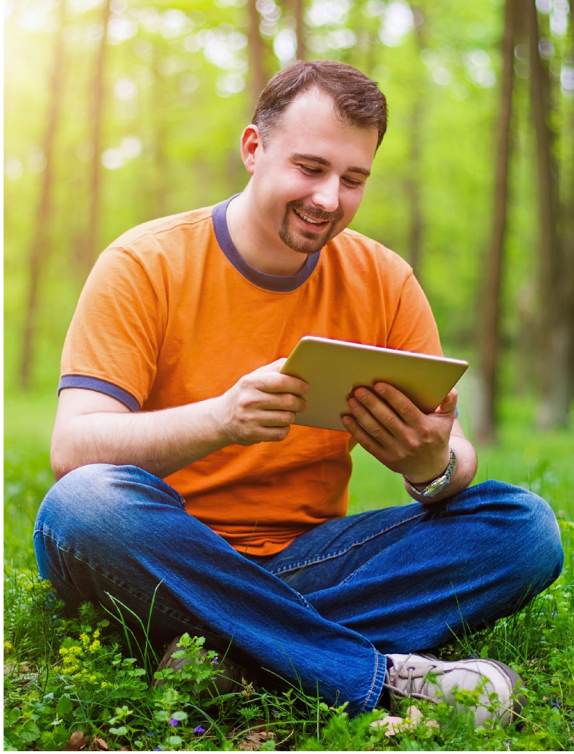

IV Produkt Cloud service

- Allows you to monitor your systems wherever you are
- Always accessible wherever there is internet access
- 4G router as option
- Alarm monitoring via e-mail or text message
- You can quickly analyse and take action for optimum operation

Keeping track of your kilowatt hours!

We are now offering an optional extra for our air handling units in the Envistar range in the form of the in-house developed software Energy Watch which helps you to keep track of your kilowatt hours.

Energy Watch is a unique function for monitoring and optimising the energy use in the air handling unit.

You can easily see the meter values and information in the app, the hand-held terminal or in BMS system.



Developed
by
IV Produkt

Energy watch measures and shows:

Heat recovery

- Recovered energy and power
- Heat recovery unit efficiency

Fans

- Energy input and power
- Specific fan power, SFP/SFPv
- Density correction of the air flow with measurement at four points for the best possible accuracy

Additional heating

- Energy input and power
- Alarm for leaking heating valve

Take control using our IV Produkt AHU Controls app

You can now control our unit using the IV Produkt AHU Controls app. You connect the unit to the internal network in the property, if the building has Wi-Fi.

If you cannot connect the unit to the internal network, we offer an optional Wi-Fi router for the unit.

IV Produkt AHU Controls app

- Control your unit easily via smartphone or tablet
- Start up the unit and adjust the values
- React quickly in the event of an alarm
- See event logging and history
- Clear interface and summary flow chart

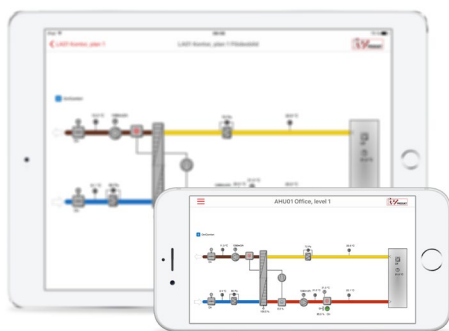

The app is available to download free of charge for iOS och Android™.

The app has lots of great functions

IV Produkt AHU Controls has plenty of great functions that make day-to-day management of your IV Produkt air handling unit easier for you. You can adjust setpoints and settings, see any alarms and much more without needing to be in the plant room. It can save you a lot of running up and down stairs!

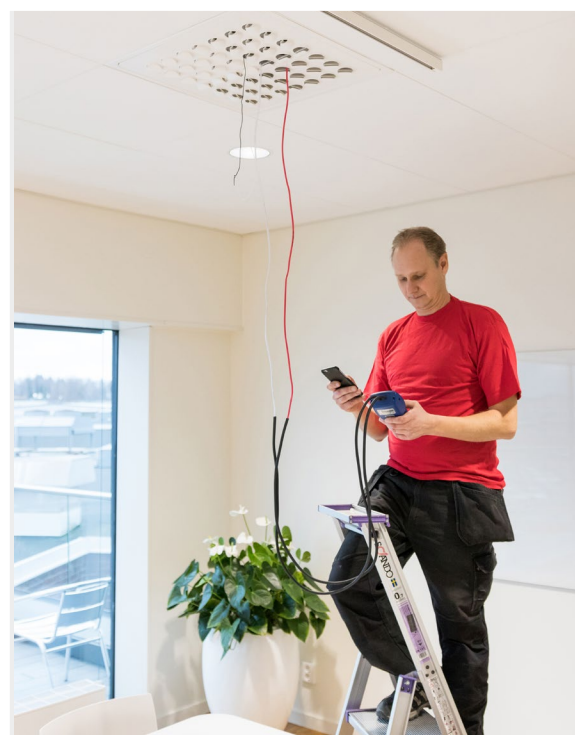

Can you afford not to?

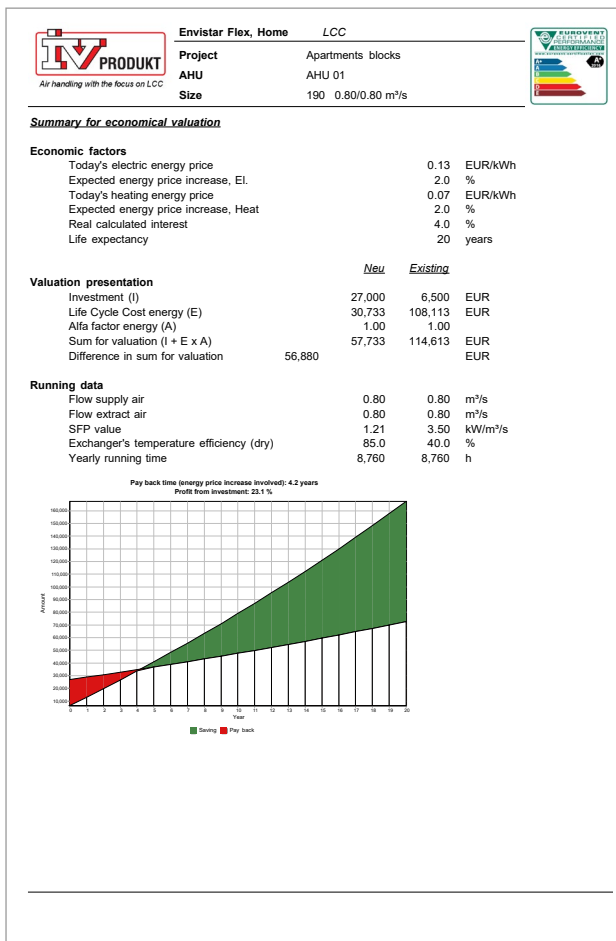

IV Produkt Designer quickly gives you a calculation of LCC, payback time and profit for the unit, as well as the increase in value of the property.

Here, you can follow an example calculation for a completed project for a block of flats.

Operating data	New	Existing
Supply air flow	0.80	0.80 m³/s
Exhaust air flow	0.80	0.80 m³/s
SFPv value	1.23	3.50 kW/m³/s
Temperature efficiency	85.0%	40%
Annual operating time		8,760 h
Investment cost for unit and installation		27,000 €
Pay-back time with regard to energy saving		4.2 years
Profit from investment (excluding calculated interest)		23.1%

Added value for the property

Calculated energy cost saving/
Increased net operation
Profit requirement = **Calculated added value**

$$\frac{4,739}{8\%} = 59,234 \text{ €}$$

In the example above, the net operation has increased by 4,739 €. This is divided by the profit requirement of **8 percent**. With a property value of **3 million €** before the energy saving, the property will increase in value by approx. **2 percent** after the investment.

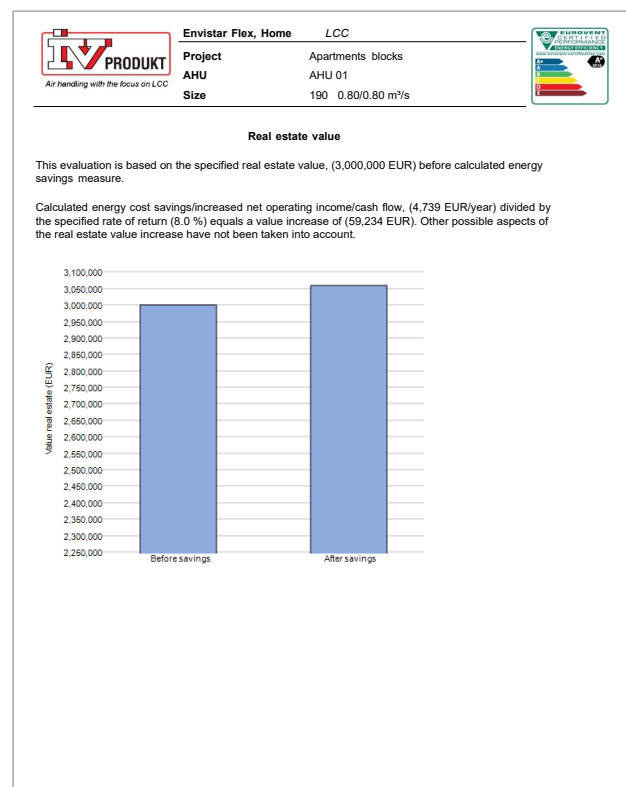

Projects we have delivered to...

Here is just a tiny selection of the thousands of projects in which, together with consultants and installation firms, we have used our wide range of products to deliver innovative solutions for energy-efficient and cost-effective air handling.



Scania in Oskarshamn, Sweden



Gothia Towers in Gothenburg, Sweden



Harpa Concert Hall in Reykjavik, Iceland



Northern Europe's biggest hospital, Aarhus University Hospital, Skejby, Denmark



Titanic Museum in Belfast, United Kingdom

... over the years



UNN PET medical center, Tromsø, Norge. Architect: LINK arkitektur.



ÅF's head office in Stockholm, Sweden.
Approved in accordance with Green Building



Kastrup Airport, Copenhagen, Denmark



Bieberhaus in Hamburg, Germany, is an old building with everything from shops to theatre and offices



Air handling with focus on LCC

Envistar® Top

Configuration with rotor

Right or left handed configuration selected during planning. Below is an example of a right-handed configuration.

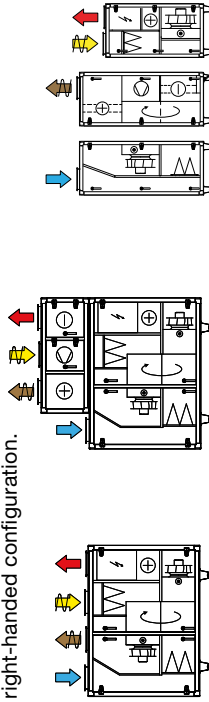

Sizes 04, 06 and 10

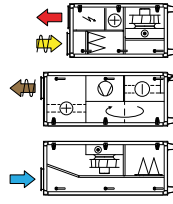

Sizes 09 and 12 with cooling unit

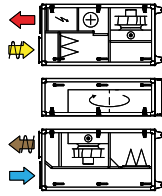

Sizes 12, 16 and 21

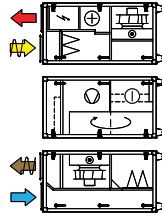

Sizes 16 and 21 with cooling unit

Envistar Top 09, 12, 16 and 21 are supplied in three sections. Each section has a max. width of 890 mm.

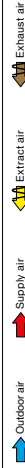

Technology

- Duct connections upward
- 7 sizes
- Air flow 0.10–2.0 m³/s
- EC motors with very high efficiency
- EcoCooler cooling unit with cooling recovery (optional extra)
- ThermoCooler HP reversible heat pump (optional extra)
- Control equipment Siemens Climatix
- Energy optimisation function – ECO
- Rotary heat exchanger
- Saves up to 75% floor space
- Damper for recirculated air operation as an option

Available external pressure

See IV Produkt Designer for object-specific data.

Duct accessories

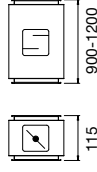

Capacity and technical data

Size	Dimensions (mm)		Air handling unit excluding cooling unit				Air handling unit with integrated cooling unit					
	Height excl./incl. cooling unit	Length excl./incl. cooling unit	Air flow (m ³ /s) ^a		External fuse protection ^c	Weight (kg) ^d	Air flow (m ³ /s) ^a		Cooling power (kW)	Refrigerant volume (kg)	External fuse protection ^c	Weight (kg)
			Min.	SFP _v 1.5			SFP _v 1.8	Max. ^b				
04	1,365 1,910	1,570	0.10	0.30	0.40	0.43	10 A	255	0.12	0.35	0.35	380
06	1,365 1,910	1,720	0.15	0.50	0.61	0.68	10 A	305	0.15	0.55	0.60	440
09	1,435 1,600	2,000 ^e 2,370	0.20	0.70	0.83	0.98	10 A	450	0.20	0.75	0.95	570
10	1,435 1,980	1,990	0.20	0.70	0.83	0.98	10 A	395	0.20	0.75	0.95	550
12	1,530 1,915	2,000 ^e 2,370	0.25	0.98	1.17	1.20	10 A	530	0.25	1.07	1.15	660
16	1,741	2,200 ^f 2,670	0.30	1.25	1.46	1.64	10 A	635	0.41	1.34	1.60	790
21	1,885	2,200 ^f 2,670	0.40	1.68	1.93	2.10	16 A	820	0.61	1.76	2.10	1,010 1,040

a - For units with dampers, F7 filter supply air, M5 filter extract air, rotor, water coil 60/30°C with supply air temp +20°C and duct pressure: 150 Pa (size 04), 200 Pa (size 6-21)

b - Technical Maximum Flow

c - 3x400 V+N+PE 50 Hz, fuse with type C characteristics

d - Including water coil heating (not filled with liquid)

e - Supplied in three sections that have a max. width of 790 mm

f - Supplied in three sections that have a max. width of 890 mm

g - Top 04 with cooling unit has duct connection 500 x 200 mm

h - Refrigerant R410a

i - Refrigerant R134a

For object-specific data,
see the product selection program IV Produkt Designer

Envistar® Top with ThermoCooler HP

Configuration with rotor

Right or left handed configuration selected during planning. Below is an example of a right-handed configuration.

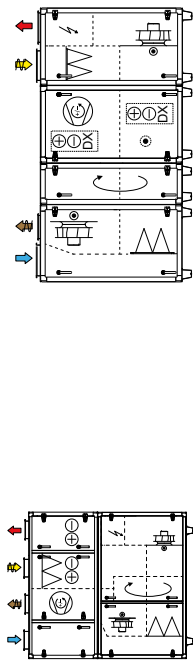

Rotor and reversible heat pump sizes 06 and 10 Rotor and reversible heat pump sizes 09, 12, 16 and 21

Technology

- 6 sizes
- Air flow 0.25–2.00 m³/s
- Control equipment Siemens Climatix
- Cooling/heating pump ThermoCooler HP
- Rotary heat exchanger



Capacity and technical data

Size	Dimensions (mm)			Air handling unit with integrated cooling/heating pump						Weight (kg)			
	Width	Height	Length	Duct connection	Air flow (m ³ /s) a			Cooling power (kW)	Refrigerant volume c (kg)		External fuse protection d	External fuse protection e	
					Min.	SFP 1.5y	SFP 1.8y						Max. b
06	890	1,910	1,720	600x250	0.25	0.42	0.57	0.60	13	1.70	16A	Common	310
09	1,020	1,435	2,790 f	700x300	0.20	0.64	0.78	0.98	15	2.80	16A	Common	450
10	1,020	1,980	1,990	700x300	0.20	0.70	0.82	0.98	16	2.70	16A	Common	400
12	1,200	1,530	2,790 f	900x300	0.25	0.94	1.16	1.20	24	4.10	25A	Common	540
16	1,295	1,741	2,990 g	900x350	0.41	1.21	1.40	1.60	27	4.90	25A	Common	650
21	1,616	1,885	2,990 g	1,200x350	0.61	1.55	1.84	2.10	33	6.68	32A	Common	830

a - For units with damper, supply air filter ePM1 50%, extract air filter ePM10 60%, Blank NE rotor and duct pressure 200 Pa

b - Technical Maximum Flow

c - Refrigerant R410a

d - 3x400 V+NHPE 50 Hz, fuse with type C characteristics

e - External fuse protection for the ThermoCooler HP reversible heat pump

f - Supplied in four sections that have a max. width of 790 mm

g - Supplied in four sections that have a max. width of 890 mm

For heating powers and object-specific data, see the product selection program IV Produkt Designer

Envistar® Top

Configuration with counter-flow exchanger

Right or left handed configuration selected during planning. Below is an example of a right-handed configuration.

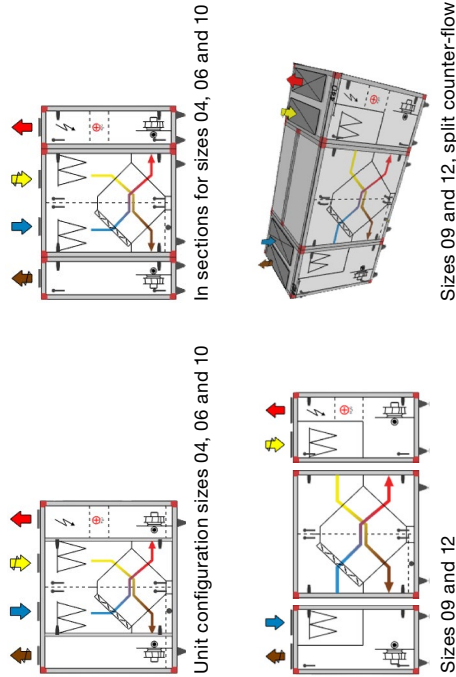

Technology

- Duct connections upward
- 5 sizes
- Air flow 0.13–1.15 m³/s
- EC motors with very high efficiency
- Control equipment Siemens Climatix
- Energy optimisation function – ECO
- Energy recovery unit – counter-flow exchanger
- Saves up to 75% floor space

Available external pressure

See IV Produkt Designer for object-specific data.

Duct accessories

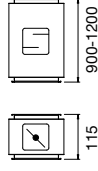

Smoke-bypass

Sits on the heat exchanger exhaust air section on the reverse side of the unit.

- Size 04 ø 200 mm
- Size 06 ø 250 mm
- Size 09 ø 315 mm
- Size 10 ø 315 mm
- Size 12 ø 315 mm

Capacity and technical data

Size	Dimensions (mm)				Air handling unit						
	Width	Height	Length, unit	Length, in sections	Duct connection	Air flow (m ³ /s) ^a			External fuse protection ^c	Weight ^d (kg)	
						Min.	SFP _v 1.5	SFP _v 1.8			Max. ^b
04	748	1,540	1,820	2,067	Ø 315 / 500 x 200	0.13	0.34	0.42	0.42	10 A	310
06	890	1,625	1,960	2,207	Ø 315 / 500 x 250	0.18	0.47	0.59	0.60	10 A	390
09	1,020	1,530	–	3,040	700 x 300	0.25	0.67	0.81	0.95	10 A	580
10	1,020	1,990	2,215	2,466	700 x 300	0.25	0.70	0.82	0.95	10 A	610
12	1,200	1,530	–	3,040	900 x 300	0.30	0.76	0.97	1.10	10 A	650

a - For units with dampers, F7 filter, supply air, M5 filter, extract air, counter-flow exchanger, water coil 60/30°C with supply air temp +20°C and duct pressure: 150 Pa (size 04), 200 Pa (size 6-12)

b - Technical Maximum Flow

c - 3x400 V+N+PE 50 Hz, fuse with type C characteristics

d - Including water coil heating (not filled with liquid)

For object-specific data, see the product selection program IV Produkt Designer

Envistar® Compact

Configurations

Connections for outdoor air, supply air, extract air and exhaust air can be positioned on the upper or lower level. The unit can be supplied in right or left handed configuration. Below is an example of a right-handed configuration.

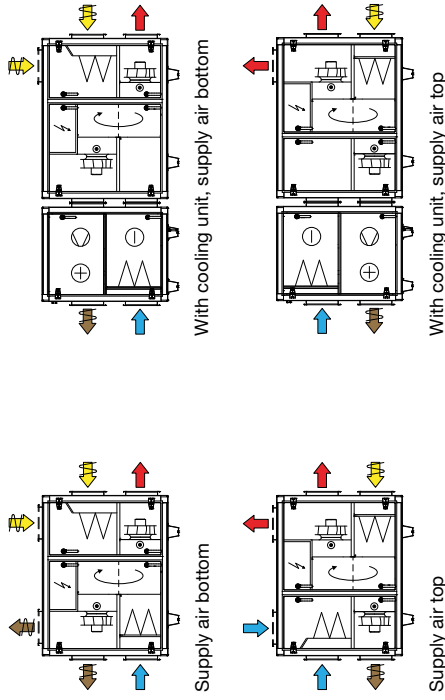

Technology

- Duct connections upward/side
- 4 sizes
- Air flow 0.10–1.50 m³/s
- EC motor with very high efficiency
- Cooling unit as an option

Available external pressure

See IV Produkt Designer for object-specific data.

Duct accessories

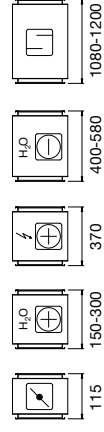

Capacity and technical data

Size	Dimensions (mm)		Air handling unit excluding cooling unit						Air handling unit with integrated cooling unit					
	Width	Height	Length excl./incl. cooling unit	Duct connection	Air flow (m³/s) ^a			Weight ^d (kg)	External fuse protection ^c	Cooling power (kW)	Refrigerant volume ^e (kg)	External fuse protection ^c	Weight ^d (kg)	
					Min	SFP _y 1.5	SFP _y 1.8							Max. ^b
04	748	1,250	1,435/ 2,475	Ø 315	0.10	0.32	0.41	0.44	189	10 A	4.7	1.5	10A	337
06	890	1,312	1,555/ 2,525	500 x 300	0.15	0.47	0.58	0.65	227	10 A	6.6	2.5	10A	427
10	1,020	1,413	1,616/ 2,586	700 x 400	0.20	0.64	0.82	0.97	284	10 A	12	3.0	10A	539
16	1,295	1,688	1,860/ 2,830	1,000 x 500	0.30	1.31	1.52	1.65	429	10 A	16	6.0	16A	741
											22	6.0	20A	751

a - For units with dampers, F7 filter supply air, M5 filter extract air, rotor, water coil 60/30°C with supply air temp +20°C and duct pressure: 150 Pa (size 04), 200 Pa (sizes 6–16)

b - Technical Maximum Flow

c - 3x400 V+N+PE 50 Hz, fuse with type C characteristics

d - Excluding water coil heating (duct-mounted)

e - Refrigerant R134a

For object-specific data,
see the product selection program IV Produkt Designer

Envistar® Flex

Configurations

Connections for outdoor air, supply air, extract air and exhaust air can be positioned on the upper or lower level. The unit can be supplied in right or left handed configuration. Below is an example of a right-handed configuration.

Available external pressure

See IV Produkt Designer for object-specific data.

Technology

- 15 sizes
- Air flow 0.10–11.5 m³/s
- The fans have PM motors with EC or frequency inverter control
- EcoCooler cooling unit with or without cooling recovery (optional extra)
- ThermoCooler HP reversible heat pump (optional extra)
- Control equipment Siemens Climatix
- Energy optimisation function – ECO
- Rotary heat exchanger, plate heat exchanger or coil recovery
- Indoor or outdoor version
- Recirculating unit as an option

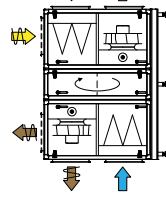

Comb. 1 Rotor

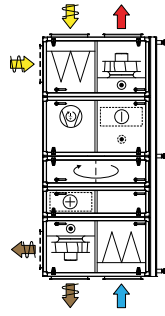

Comb. 3 Cooling unit with cooling recovery

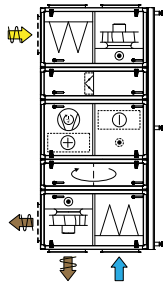

Comb. 4 Rotor and recirculating unit

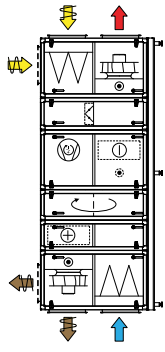

Comb. 6 Cooling unit with cooling recovery and recirculating unit

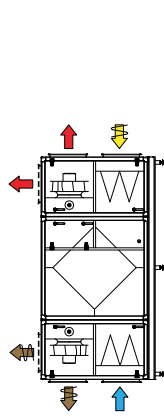

Comb. 5 Rotor, cooling unit and recirculating unit

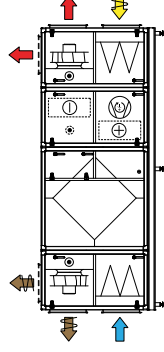

Comb. 8 Plate heat exchanger and cooling unit

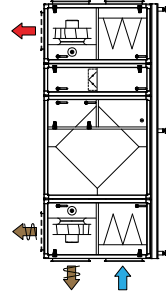

Comb. 9 Plate heat exchanger and recirculating unit

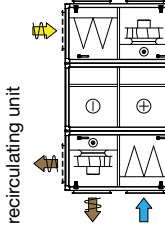

Comb. 10 Plate heat exchanger, cooling unit, recirculating unit

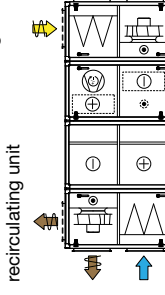

Comb. 11 Run-around coil unit

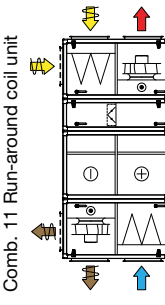

Comb. 12 Run-around coil unit and cooling unit



Comb. 13 Run-around coil unit and recirculating unit



Comb. 14 Run-around coil unit, cooling unit, recirculating unit

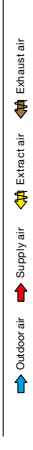

Capacity and technical data

Size	Dimensions (mm)		Air handling unit excluding cooling unit				Air handling unit with integrated cooling unit				Weight f comb. 1 (kg)	Weight f comb. 2 (kg)		
	Width a	Height b	Duct connection	Control cabinet placement	Air flow (m³/s) c		Output variant	Air flow (m³/s) c		Cooling power (kW)			Refrigerant volume g (kg)	External fuse protection h
					Min	SFPv 1.5		Max. d	Min.					
060	890	960	500 x 300	On unit roof	0.11	0.40	0.60	–	–	–	–	–	–	
100	1,020	1,090	700 x 300	On unit roof	0.17	0.72	0.99	2 V	0.76	1.01	18.1	1.9	10	
150	1,120	1,470	800 x 500	On unit roof	0.29	1.18	1.70	2 V	0.33	1.23	26.7	3.0	16	
190	1,400	1,470	1,000 x 500	On unit roof	0.38	1.67	2.00	2 V	0.42	1.74	36.1	4.1	20	
240	1,400	1,686	1,000 x 600	On supply air end	0.47	1.97	2.60	2 V	0.49	2.05	37.2	4.6	20	
300	1,616	1,686	1,200 x 600	On supply air end	0.54	2.48	3.00	2 V	0.57	2.52	47.9	5.4	25	
360	1,616	2,060	1,200 x 800	On supply air end	0.66	2.86	3.80	2 V	0.74	2.82	60.4	6.7	32	
400	1,880	1,900	1,400 x 700	On supply air end	0.66	3.10	4.00	2 V	0.80	3.30	67.3	7.3	32	
480	1,990	2,060	1,400 x 800	On supply air end	0.85	4.04	5.10	1 V	0.93	4.15	52.2	8.5	32	
								2 V	4.10	4.66	85.9	8.5	40	
600	2,200	2,270	1,600 x 800	On supply air end	1.06	4.96	6.00	1 V	5.06	5.78	65.7	8.4	32	
								2 V	1.16	5.06	90.4	8.4	40	
								3 V	5.05	5.05	106.2	6.9/3.5	50	
740	2,480	2,675	2,000 x 900	In units next to TF fans	1.21	6.31	8.30	2 V	1.42	6.39	97.1	11.2	40	
								3 V	6.38	7.08	131.8	10.3/4.6	63	
850	2,560	2,935	2,200 x 1,000	In units next to TF fans	1.41	7.32	10.0	1 V	7.50	8.06	102.5	12.8	40	
								2 V	1.61	7.41	123.3	10.3/6.5	50	
								3 V	7.41	7.41	153.7	10.3/6.5	63	
980	2,860	3,085	2,400 x 1,100	In units next to TF fans	1.69	8.43	10.6	1 V	1.95	8.82	107.1	16.2	40	
								2 V	8.82	9.77	164.5	11.6/8.2	80	

Download the product selection program IV Produkt Designer for technical data for sizes 1250–1540.

Length (mm)

Size	Combination (indicates indoor version)													
	1	2	3	4	5	6	7	8	9	10	11	12	13	14
060	1,760	–	–	2,200	–	–	2,460	–	2,900	–	2,310	–	2,750	–
100	1,760	2,580	3,000	2,200	3,020	3,440	2,460	3,280	2,900	3,760	2,310	3,130	2,750	3,570
150	2,060	2,880	3,300	2,500	3,320	3,740	3,060	3,880	3,500	4,360	2,610	3,430	3,050	3,870
190	2,060	2,880	3,300	2,500	3,320	3,740	3,060	3,880	3,500	4,360	2,610	3,430	3,050	3,870
240	2,200	3,020	3,440	2,640	3,460	3,880	3,500	4,320	3,940	4,800	2,750	3,570	3,190	4,010
300	2,200	3,020	3,440	2,640	3,460	3,880	3,500	4,320	3,940	4,800	2,750	3,570	3,190	4,010
360	2,660	3,550	3,970	3,300	4,190	4,610	4,260	5,150	4,900	5,830	3,210	4,100	3,850	4,740
400	2,200	3,090	3,510	2,642	3,532	3,952	3,500	4,390	3,942	4,832	2,750	3,640	3,192	4,082
480	2,960	3,850	4,270	3,600	4,490	4,910	4,560	5,450	5,200	6,130	3,510	4,400	4,150	5,040
600	2,960	3,850	4,270	3,600	4,490	4,910	4,560	5,450	5,200	6,130	3,510	4,400	4,150	5,040
740	3,260	4,230	4,650	3,900	4,870	5,290	4,860	5,830	5,500	6,510	3,850	4,820	4,490	5,460
850	3,260	4,230	4,650	3,900	4,870	5,290	4,860	5,830	5,500	6,510	3,850	4,820	4,490	5,460
980	3,260	4,230	4,650	3,900	4,870	5,290	4,860	5,830	5,500	6,510	3,850	4,820	4,490	5,460

Control cabinet increases the length by 290 mm on sizes 240–600.

a - Control cabinet increases the width by 170 mm on sizes 240 to 600. Above the rotor, width increases by 50 mm.

b - Stand increases the height by 200 mm for sizes 100–600. On sizes 740–980, the stand is standard. Control cabinet increases the height by 290 mm on sizes 100–190.

c - For units with dampers, F7 filter supply air, M5 filter extract air, rotor, water coil 60/30°C with supply air temp +20°C and duct pressure 200 Pa

d - Technical Maximum Flow

e - External fuse protection for the Envistar Flex unit. 3x400 V+N+PE 50 Hz, fuse with type C characteristics.

f - Fuse protection varies depending on choice of fans/power variants

g - Including water coil heating (not filled with liquid)

h - Refrigerant R410a

i - 3x400 V+N+PE 50 Hz, fuse with type C characteristics

For object-specific data, see the product selection program IV Produkt Designer

Duct accessories

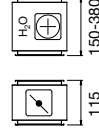

Control cabinet

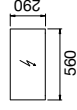

For position, see table above.

Envistar® Flex with ThermoCooler HP

Configurations

Connections for outdoor air, supply air, extract air and exhaust air can be positioned on the upper or lower level. The unit can be supplied in right or left handed configuration. Below is an example of a right-handed configuration.



Rotor and cooling/heating pump

Technology

- 12 sizes
- Air flow 0.25–8.60 m³/s
- Control equipment Siemens Climatix
- Cooling/heating pump ThermoCooler HP
- Rotary heat exchanger
- Indoor or outdoor configuration

Capacity and technical data

Size	Dimensions (mm)			Control cabinet position	Output variant	Air flow (m ³ /s) ^c				Refrigerant volume ^e (kg)	External fuse protection ^f vent.	External fuse protection ^g kVp	Weight (kg)	
	Width	Height ^a	Length ^b			Duct connection	Min.	SFP 1.8 _y						Max. ^d
								SFP 1.5 _y	SFP 1.8 _y					
100	1,360	1,090	2,550	700 x 300	On unit roof	2 V	0.25	0.52	0.72	0.95	13.2	2.8	10 A	620
150	1,460	1,470	2,850	800 x 500	On unit roof	2 V	0.38	0.88	1.11	1.61	21.3	4.6	10 A	820
190	1,740	1,470	2,850	1,000 x 500	On unit roof	2 V	0.50	1.29	1.65	2.12	27.1	5.8	16 A	940
240	1,740	1,686	2,990	1,000 x 600	On supply air end	2 V	0.58	1.48	1.86	2.48	29.1	7.0	16 A	1,070
300	1,956	1,686	3,020	1,200 x 600	On supply air end	2 V	0.68	1.89	2.42	2.91	40.1	8.2	16 A	1,160
360	1,956	2,060	3,550	1,200 x 800	On supply air end	2 V	0.85	2.10	2.72	3.64	48.3	10.1	16 A	1,465
400	2,200	1,900	3,090	1,400 x 700	On supply air end	2 V	0.92	2.70	3.32	3.93	51.0	10.7	25 A	1,380
480	2,330	2,060	3,850	1,400 x 800	On supply air end	2 V	1.07	3.13	3.98	4.61	65.1	13.2	32 A	1,930
600	2,540	2,270	3,850	1,600 x 800	On supply air end	2 V	1.34	3.85	4.83	5.75	81.7	10.4/5.8	32 A	2,165
740	2,820	2,675	4,150	2,000 x 900	In units next to TF fans	2 V	1.71	4.78	5.96	7.34	99.5	14.0/6.0	32 A	2,500
850	2,900	2,935	4,150	2,200 x 1,000	In units next to TF fans	2 V	1.98	5.67	6.82	8.47	113.3	14.0/9.0	40 A	2,800
980	3,200	3,085	4,150	2,400 x 1,100	In units next to TF fans	2 V	2.38	6.50	8.00	10.05	129.1	17.4/12.6	40 A	3,200

a - Stand increases the height by 200 mm on sizes 100–600. On sizes 740–980, the stand is standard.

b - Control cabinet increases the height by 290 mm on sizes 100–190.

c - For units with dampers, F7 filter supply air, M5 filter extract air, rotor with supply air temp +20°C and duct pressure 200 Pa

d - Technical Maximum Flow

e - Refrigerant R410a

f - External fuse protection for the Envistar Flex unit. 3x400 V+N+PE 50 Hz, fuse with type C characteristics

g - External fuse protection for the ThermoCooler HP reversible heat pump. 3x400 V+N+PE 50 Hz, fuse with type C characteristics

For heating powers and object-specific data, see the product selection program IV Produkt Designer

Knowledge drives the whole industry forwards



At IV Produkt, we will show future generations that ventilation is an industry of the future. Through training, product development and an informative website, we will become a knowledge company and drive the industry forwards.

We are happy to share the knowledge we have accrued with you. Take advantage of our knowledge online, contact us or visit IV Produkt Competence Center, which is an established meeting place for knowledge, conferences and training.

Documentation – where and whenever you want it



Here you can find brochures and technical documentation for all our products.

Order-controlled operation & maintenance

State **your order no** to find unique documentation for your unit.

Applies to units delivered in 2015 onwards.

Unique order documentation is created for each unit we supply. This relates to operation and maintenance instructions, building product declaration, technical data, configuration and control diagram. By entering the order number at ivprodukt.com, you can digitally download the documentation for the unit. This service is available for all units delivered from 1 January 2015.

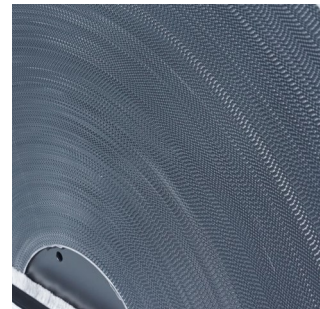
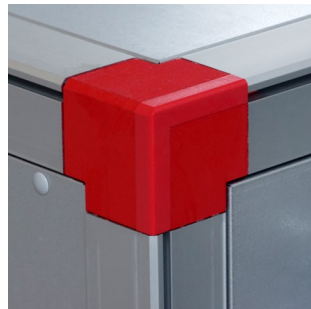
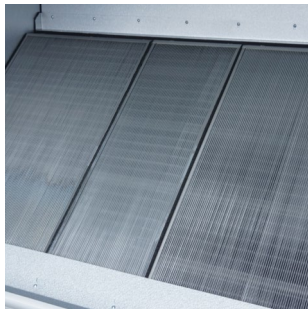
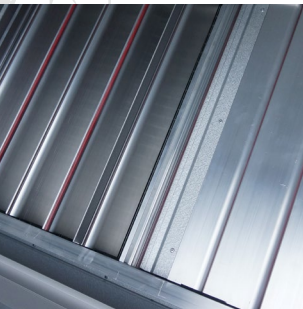
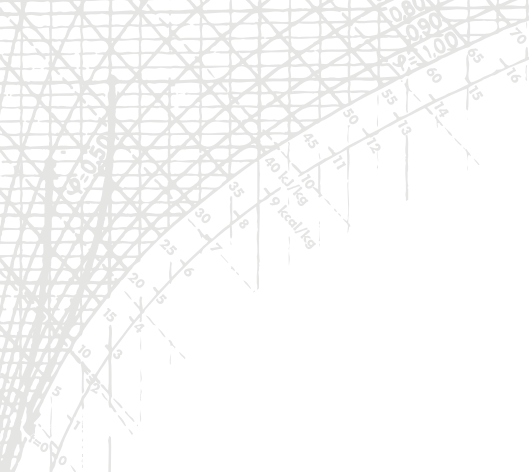

This is just part of our wide range. For our full range, see www.ivprodukt.com or contact us to find out more.

You are welcome to contact us

Head office

Box 3103, Sjöddevägen 7

SE-350 43 Växjö

Switchboard: +46 (0)470 75 88 00

Control support: +46 (0)470 75 89 00

info@ivprodukt.se

www.ivprodukt.com

IV Produkt Ltd

Sweden House, 4th Floor,

5 Upper Montagu Street,

LONDON W1H 2AG

Phone: 020 7258 5152



Air handling with focus on LCC