

B2B Brochure

# FRIDAY

Refined Access Technology

 [fridayhome.net](https://fridayhome.net)

 [@fridayhomeofficial](https://www.facebook.com/fridayhomeofficial)

 [@fridayhome\\_net](https://www.instagram.com/fridayhome_net)

## Design

4-6

## Manufacturing

7-18

The UNO

9-10

The DUO

11-12

The Bell

13-14

The LINK

15-16

FRIDAY Access

17

Security

18

## Projects

19-22

Rental Homes

20

Property Management

21

Partnership

22

## Construction Sites

23-25

# This is FRIDAY

---



---

We make automation simple. Our products are designed to provide perfect functionality in an easy-to-use manner, all wrapped up in an attractive package so that they blend seamlessly into a modern housing.

FRIDAY Home and our rockstar research and development team took over FridayLab's original lock in 2018 and used our collective 100+ years of experience to rethink it and make it smarter and more secure.

We are not alone. We partnered with design, manufacturing and hardware powerhouses to bring the market internationally compatible locks that look nice, are secure and adapt to the ever-changing technology and user needs.



**DESIGN**





## Design

The FRIDAY family is designed by Bjarke Ingels Group (BIG). The success of any consumer electronic product depends on three main factors: the design, the features and the usability.

*" We focused on creating a smart and simple design that doesn't shout, "I'm a very intelligent object on your door" with flashing lights and other tech gimmicks. Instead we optimized the most important features, kept the design simple with a nod to the classic door knob and most importantly, designed it to be as small as possible. "*

**- Jakob Lange, Partner BIG**

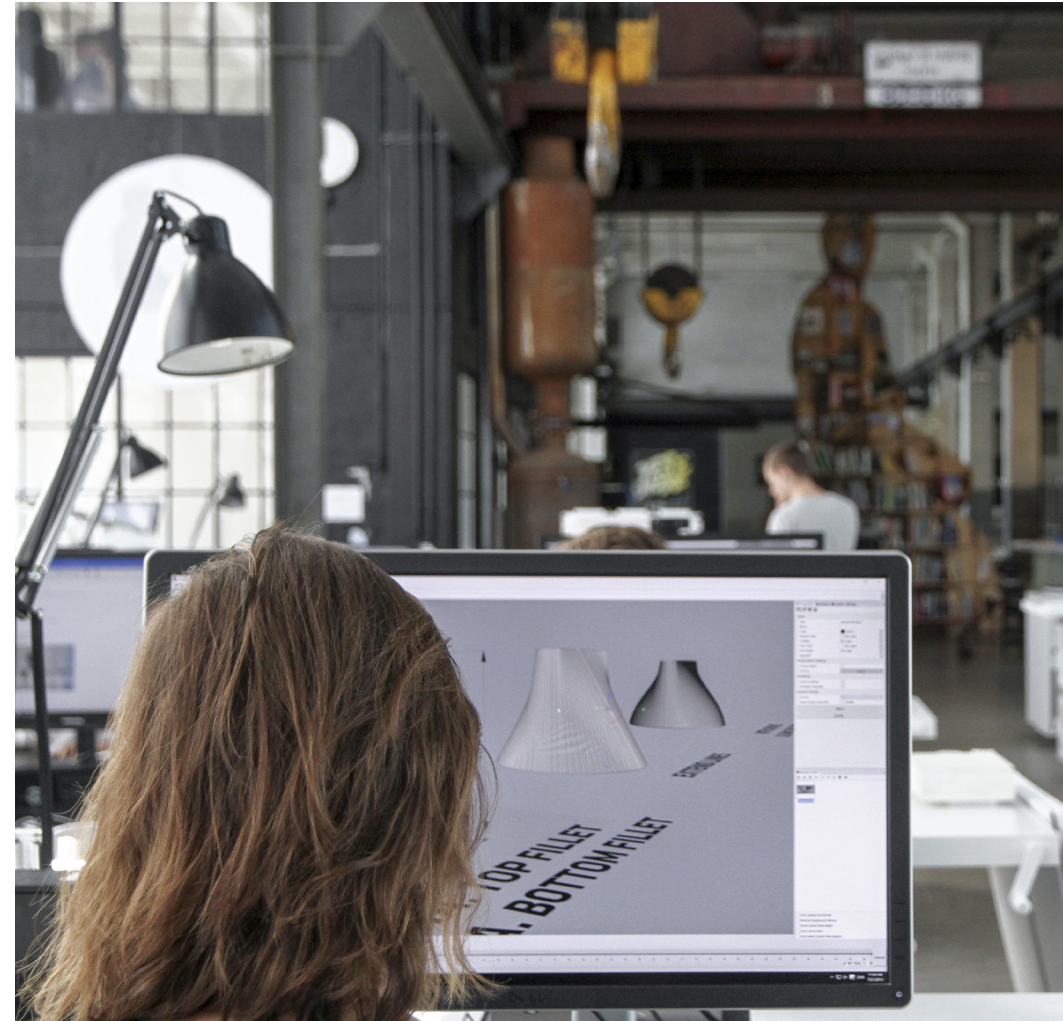

## BIG x Toyota Woven City

Together with Toyota Motor Corporation, BIG unveils Toyota Woven City as the world's first urban incubator dedicated to the advancement of all aspects of mobility at the foothills of Mt. Fuji in Japan.

Envisioned as a living laboratory to test and advance mobility, autonomy, connectivity, hydrogen-powered infrastructure and industry collaboration, Toyota Woven City aims to bring people and communities together in a future enabled by technology yet grounded in history and nature.

Located at a 175-acre former factory site in the city of Susono in Shizuoka, Toyota Woven City creates a new equality among vehicles, alternate forms of movement, people and nature, streamlined by the promise of a connected, clean and shared mobility.

The city will utilize solar energy, geothermal energy, and hydrogen fuel cell technology to strive towards a carbon neutral society, with plans to break ground in phases beginning in 2021.





# MANUFACTURING

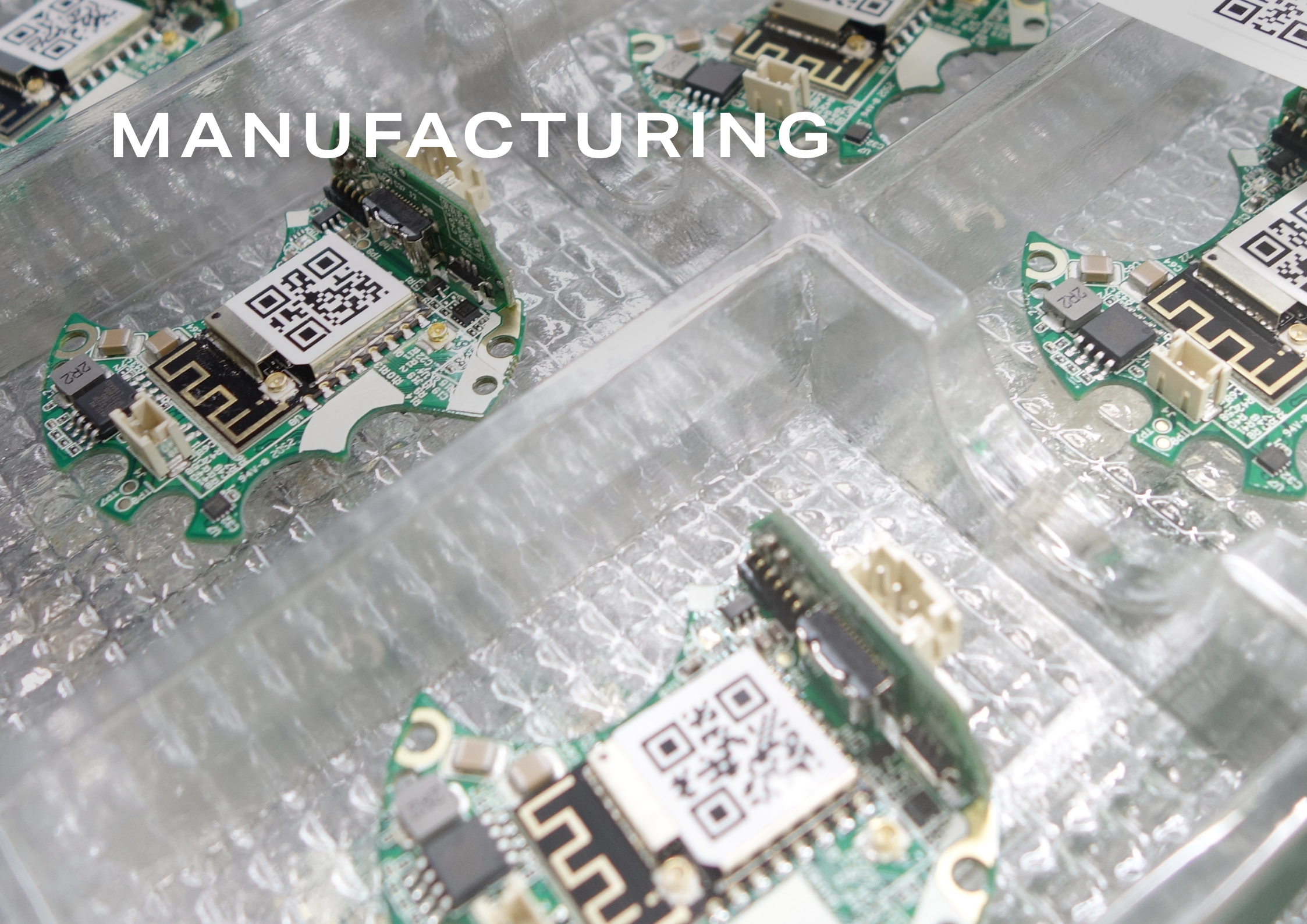



## Manufacturing

Manufacturing is the last mile of any product. Brinno unlocks the full potential of designs in order to manufacture fully optimized products that are ready for market launch.

*" Over the past 20 years, we have forged partnerships with many of the world's leading companies by providing them with a wide range of industrial design services from mechanical engineering to manufacturing. FRIDAY's unique design philosophy made it a fun and challenging project for our engineers to tackle and we are proud of the results. "*

**- David Chen, CEO of Brinno**



## The UNO

---

A superior mechanical and engineered quality smart lock that provides the needed features. With its 70.4 mm in width and 48.6 mm in height, the UNO fits existing US deadbolt locks and is offered at a competitive price point.

## Key Features

---

- 5 different shell colours
- Automatic lock/unlock
- Invite friends and family
- Grant and revoke "keys"
- Rechargeable battery
- All parts in metal
- iOS and Android compatible



## The UNO

Authentication in app: OAuth2

Bluetooth / what spec: BLE

Wi-Fi chip / what spec: ESP8266 – IEEE 802.11b/g/n

Encryption level Bluetooth: 256 bit mutually authenticated encryption  
(XSalsa20 stream cipher, Poly1305 MAC)

Encryption level Wi-Fi / internet: 256 bit mutually authenticated encryption  
(XSalsa20 stream cipher, Poly1305 MAC)

Circle operations 90 degrees: Can operate 90 degree locks

Shell colors: Nickel Satin, Steel, Brass, Bronze, Gun Metal, Copper

Shell material: Coated Zink (metal)

Weight: 292g incl. shell

Feature: Apple HomeKit

Other features: Geofence Auto Unlock, Lock on Slam, Lock on Timer

iOS & Android: iOS and Android compatible

Charging time: 3 hours

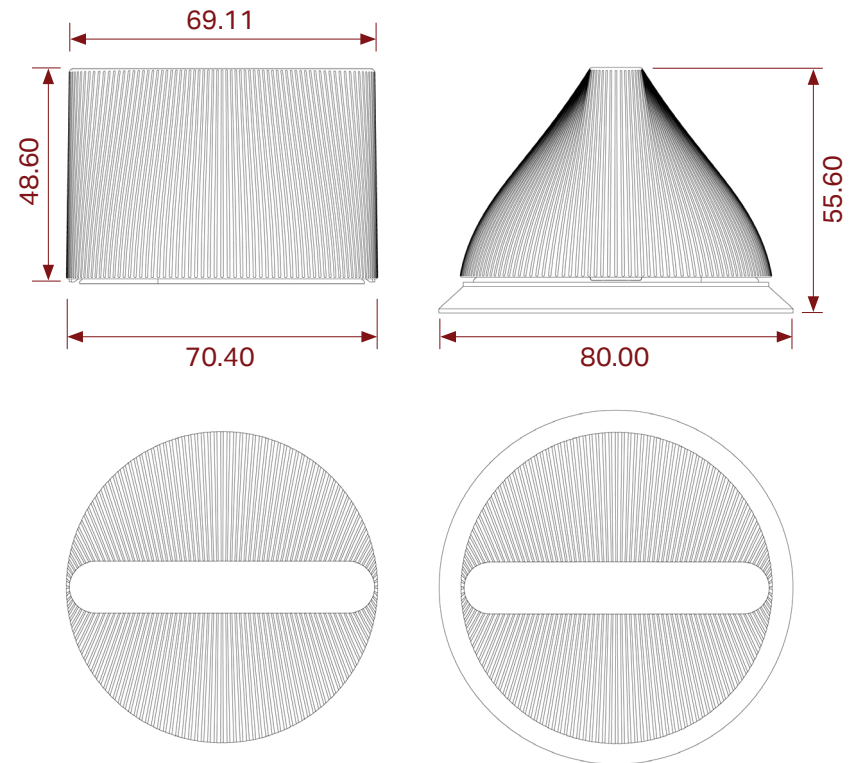



## The DUO

A combination of the best technology and high-end design. With connection to Wi-Fi the DUO can be operated remotely at any time and show its current state. The DUO has, with its 63 mm in width and 48 mm in height, the smallest volume of smart locks on the market that works with your existing lock.

## Key Features

- Automatic lock/unlock
- Invite friends and family
- Grant and revoke "keys"
- Remote operation (Wi-Fi)
- Check current state
- Rechargeable battery
- All metal construction
- iOS and Android compatible



## The DUO

Authentication in app: OAuth2

Bluetooth / what spec: BLE 5.0 - nRF52840 chip will support 5.2 later

Wi-Fi chip / what spec: Opulinks opl1000a2

Encryption level Bluetooth: Curve25519, ChaCha20-Poly1305 IETF

Encryption level Wi-Fi / internet: TLS 1.2+

Circle operations 720 degrees: Can operate 720 degrees locks

Speed 6 sec / 360

Shell colors: Steel, Matte Black, Matte White

Shell material: Coated Zink (metal)

Weight: 250g

Features: Apple HomeKit, Alexa and Google Assistant

Other features: Geofence Auto Unlock, Lock on Slam, Lock on Timer  
(auto calibration in pipeline)

iOS & Android: iOS and Android compatible

Charging time (USB-C): 2 hours 0-100%

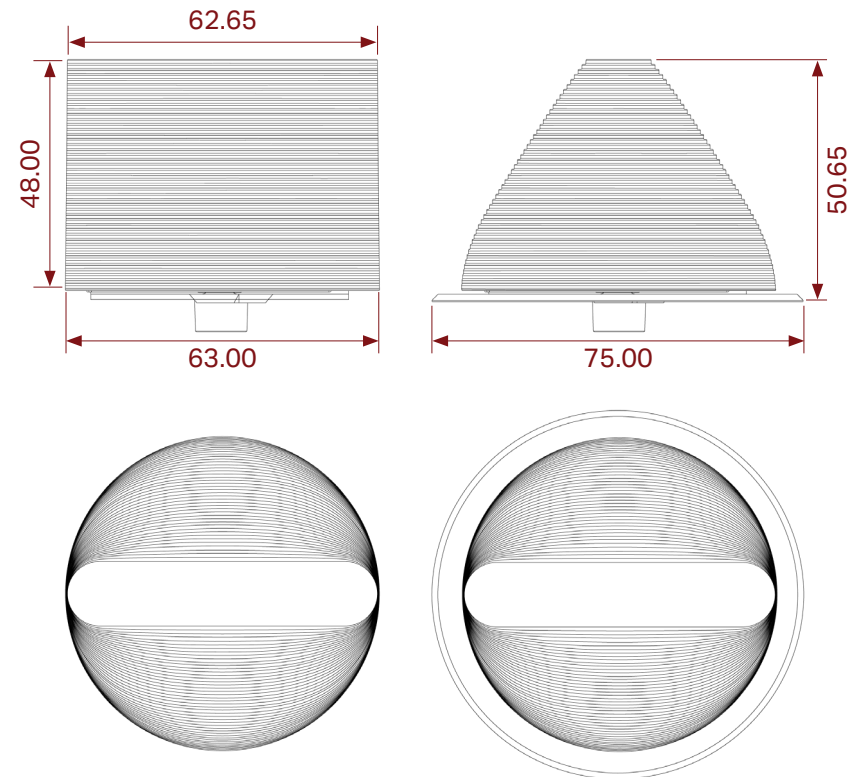

## The BELL

BELL Smart Intercom connects with the DUO Smart Lock and can be used as a simple doorbell with audio connection to visitors at the door through your phone. Thanks to Wi-Fi connectivity, the reach has no boundaries. Connected with the DUO, you and your guests can lock and unlock your door with a simple 4-8 digit code.

## Key Features

- Two-way communication: *smart bell* >< *smartphone*
- PIN code access - 4-8 digits
- Invites y-m-d-h-m
- No video violation risk
- Easy to fit – no hard wiring
- Powered by 4 replaceable AAA batteries
- iOS and Android compatible





## The BELL

Authentication in app: OAuth2

Bluetooth chip / Specific chip ID: BLE 5.0 - nRF52840 chip will support 5.2 later

Wi-Fi chip / Specific chip ID: Opulinks op1000a2

NFC Chip / Specific chip ID: NFC Supported

Encryption level Bluetooth: Curve25519, ChaCha20-Poly1305 IETF

Encryption level Wi-Fi / internet: TLS 1.2+

Speaker brand: CUI Devices - CMS-23558N-L152

Sound codec and audio quality: SmartHIFI Smart Codec With Advanced Audio

Shell: Aluminium

Features: Apple HomeKit, Alexa and Google Assistant

iOS & Android: iOS and Android compatible

Colors: Aluminium

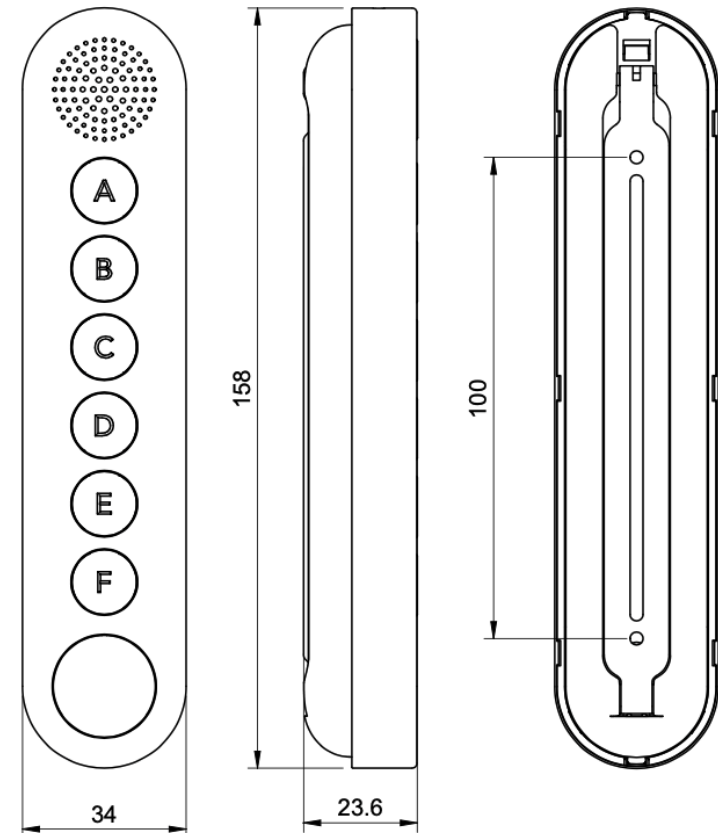

## The LINK

LINK can be powered either through hardwire installations or via FRIDAY battery bank. In current electrical installations, you can install LINK and get phone-based access control in your door. The LINK can be fitted into existing hardwired installations or into the doorframe above the electrical lock with the battery bank.

## Key Features

- Wi-Fi (low energy) – always online
- Bluetooth BLE 5.0
- Geofence triggered openings
- Remote opening
- Invites y-m-d-h-m
- No need for HUB
- Apple HomeKit
- Amazon Alexa
- Google Home

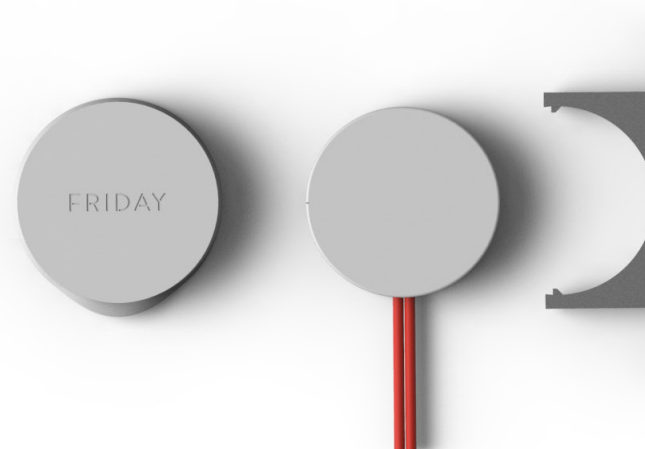

## The LINK

Authentication in app: OAuth2

Bluetooth chip / Specific chip ID: BLE 5.0 - nRF52840 chip will support 5.2 later

Wi-Fi chip / Specific chip ID: Opulinks opl1000a2

Encryption level Bluetooth: Curve25519, ChaCha20-Poly1305 IETF

Encryption level Wi-Fi / internet: TLS 1.2+

Shell: Plastic ABS

Features: Apple HomeKit, Alexa and Google Assistant

iOS & Android: iOS and Android compatible

Colors: White ABS, more colors to come

Fitment: 6-24v

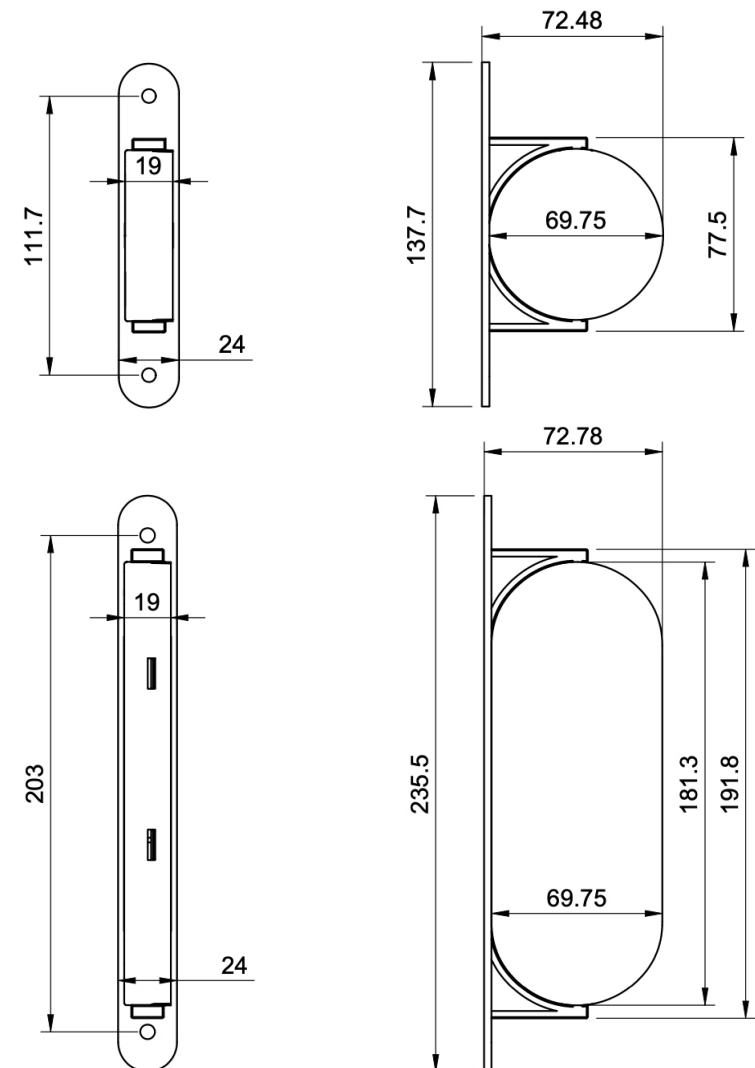

## FRIDAY Access

The cloud-based system FRIDAY Access allows you to define access rights the way you want, to whom you want and when you want. Managing your electronic keys becomes really easy with FRIDAY Access and can be controlled on any device. All FRIDAY units are online, so they respond instantly to every change you make in the system.

## Key Features

- Limit user rights locally and temporarily
- Block lost devices
- No tags
- No expensive programming tools
- API integration
- Cloud-based
- Real-time log
- Operate units directly from system
- Visual indication of door locked/unlocked
- Import projects through CSV
- Integration with active directory Microsoft 365





## Security

Asymmetric hardware encryption ensures the same level of security as a bank.

FRIDAY solutions support approved locks and comply with insurance requirements.

Signed firmware updates only get released directly from the server in the app itself.

### ***The lock is protected against jamming***

An authorized user sends the lock a message to open, but the lock does not respond. Later when an unauthorized person, who jammed the user's phone signal, tries to open the lock using that same message, the lock will still not respond. All previous encrypted messages get deleted within less than a minute after activation.

### ***The lock is channel protected***

When an authorized user sends the lock a message to open, it opens as requested. But, if an unauthorized person tries to hack and use that same message to get the lock to open, it will be denied as each message is encrypted and unique for single use.

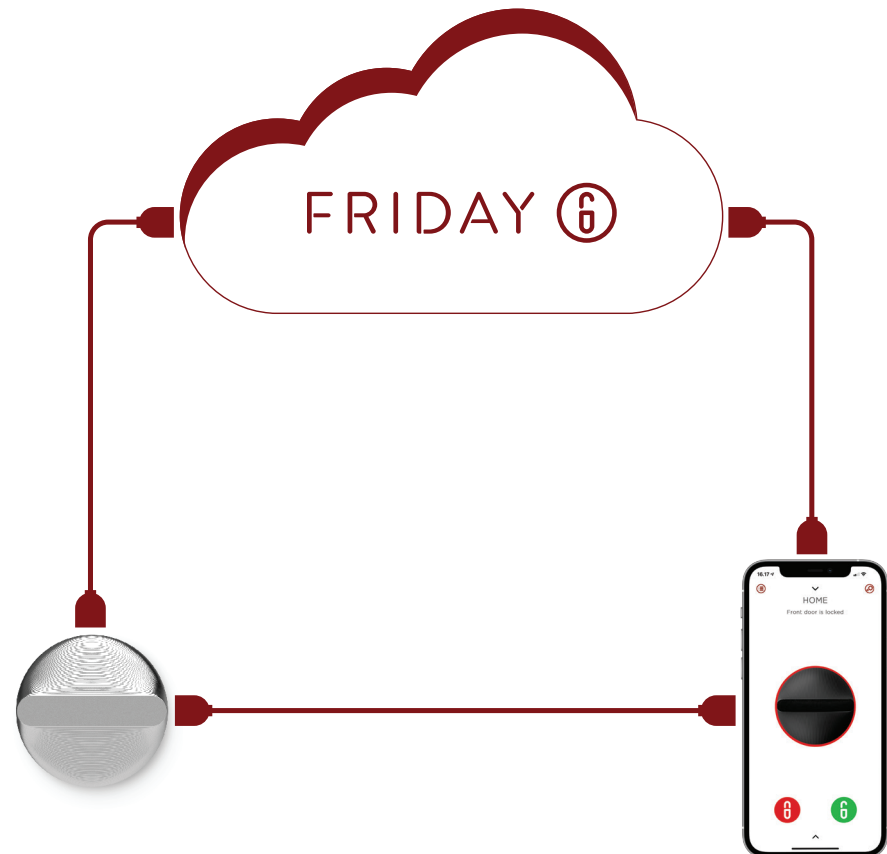

### ***Relay communication***

Even when the lock is not connected to Wi-Fi, communication with FRIDAY's cloud is secured through the FRIDAY app using end-to-end encryption.

### ***Microsoft Azure Server Hosting***

A secure hosting solution that provides intelligent encrypted databases and traffic (HTTPS) as well as continuous backups.

# PROJECTS

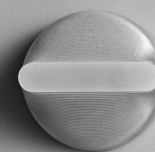

## Rental Homes

Who doesn't need a simple access to rentals?  
Use the FRIDAY Home solutions to grant and revoke access to visitors. Wherever your properties are located, reduce hassle and never worry about keys again. Set the length of your guest's booking and receive log notifications during their stay. The FRIDAY solutions can be retro fitted on most doors worldwide very easily.

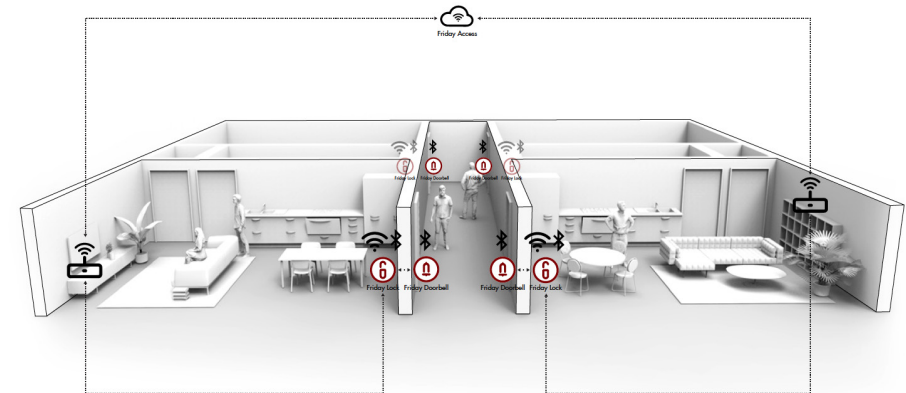

## FRIDAY solutions fit perfectly into any:

- Vacation houses / flats
- Rental meeting rooms
- Office rentals
- Rental homes
- Student housing
- ... etc.



BELL Smart Intercom  
at a vacation home

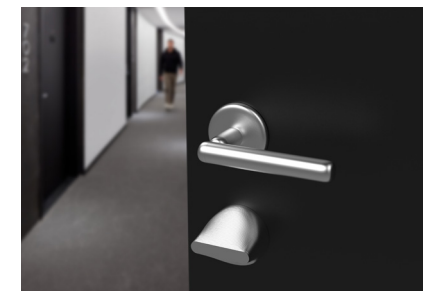

DUO Smart Lock  
at a rental home



## Property Management

Do you know who is coming and going?

It is easy to manage users and schedules in the FRIDAY Access. You do not have to worry about managing physical keys. Use the FRIDAY Home app to control access to any door on all the properties in your "keychain". Create PINs for a few weeks, a few hours or indefinitely and it is easy to scale up when you onboard a new door. FRIDAY's solutions fit every door you might have – and everything is online as long as you have Wi-Fi connection.

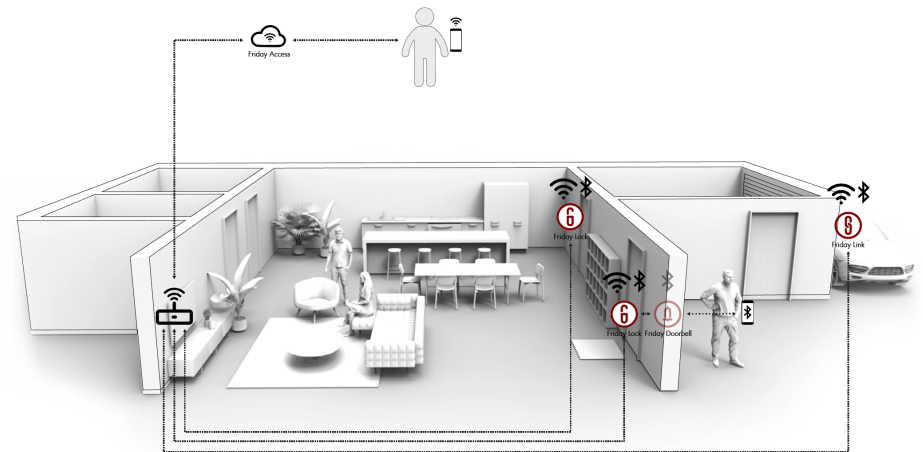

## FRIDAY solutions fit perfectly into any:

- Estates
- Gated communities
- Offices
- Hotel apartments
- Motels
- Campus
- Vacation centers
- Camping
- Marinas



BELL Smart Intercom  
on a gated community

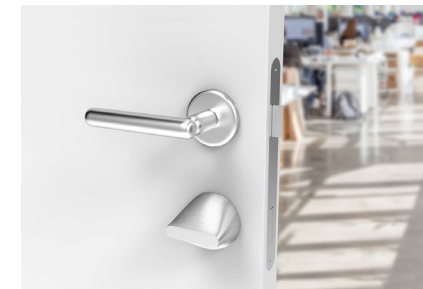

DUO Smart Lock  
in an office



## Partnership

The FRIDAY x Unloc partnership is an opportunity to integrate with FRIDAY's design and functionality. This integration and app allow individuals to use the FRIDAY products with the Unloc infrastructure that offers a universal solution for digital keys.

More often than before, consumers demand a digital or mobile solution that can compliment the more traditional solutions in access control. In a busy schedule, people want to save time wherever possible, and there are no exceptions when it comes to key management.

People increasingly want to be able to open doors with their mobile phones. At the same time, property managers are looking for solutions to save time and costs related to key management and access control.

Professional partnerships, like this with Unloc, are greatly appreciated and FRIDAY welcomes beneficial partnerships that want to integrate smart home solutions.





# CONSTRUCTION SITES

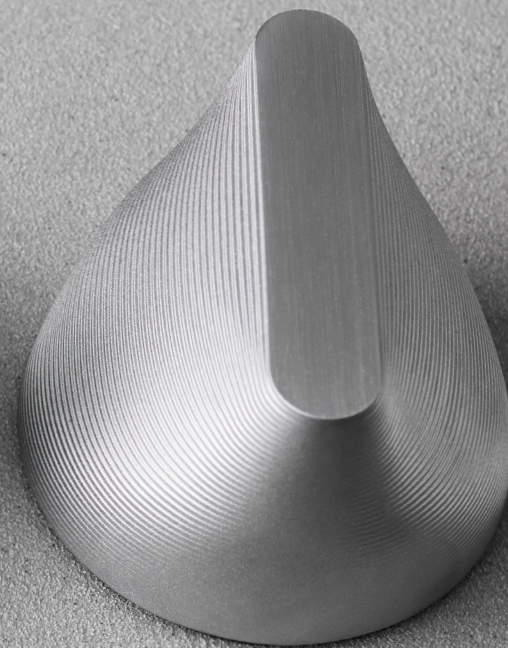



## Construction Sites

---

Everything can be done with ease from a distance. Manage your construction keys from the office or wherever you like by using the FRIDAY Access.

It is easy to manage users and schedules and keep track on different contractors, grant and/or revoke keys instantly and receive log notifications. The FRIDAY smart lock is easy to retrofit on existing doors and can be re-used on other doors and construction sites. It is easy to scale up when you onboard new doors.

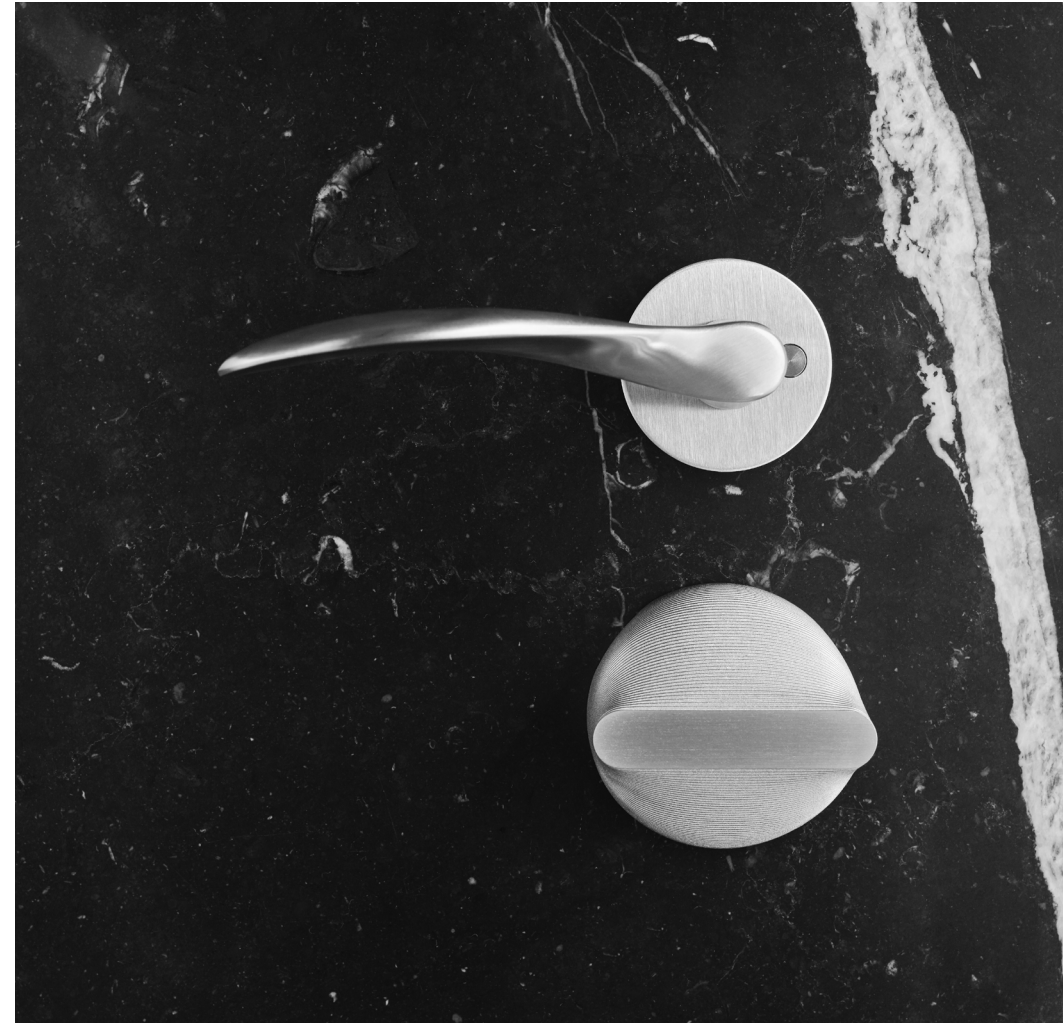



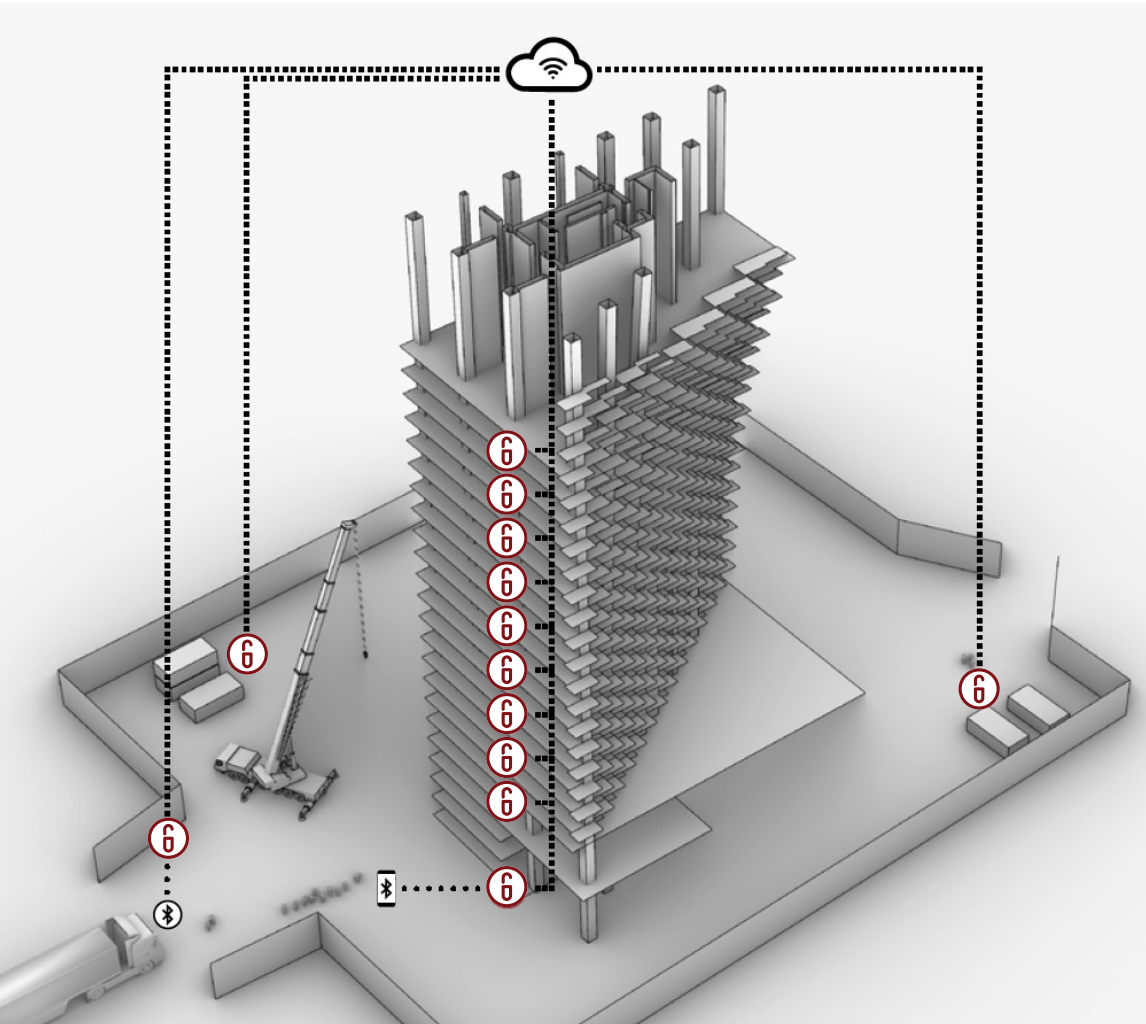











Vancouver House, BIG













LINK Smart on a construction site



DUO Smart Lock at a construction site

Item no.:	Product:
1000	 UNO Smart Lock (base unit)
1001	 UNO Smart Lock Steel
1002	 UNO Smart Lock Gun Metal
1003	 UNO Smart Lock Brass
1004	 UNO Smart Lock Bronze
1005	 UNO Smart Lock Satin Nickel
1024	 UNO Smart Lock Copper
1006	 UNO Smart Lock Battery
1007	 UNO Shell Gun Metal
1008	 UNO Smart Lock Battery Charger

Item no.:	Product:
2015	 DUO Smart Lock Stainless Steel for Scandinavia
2018	 DUO Smart Lock Stainless Steel for Europe
2021	 DUO Smart Lock Stainless Steel for US
2027	 DUO Shell Matte White for Scandinavia + EU
2028	 DUO Shell Matte Black for Scandinavia + EU
2029	 DUO Shell Matte White incl. Sub rose for US
2030	 DUO Shell Matte Black incl. Sub rose for US
3039	 BELL Smart Intercom – coming soon
3040	 LINK Smart Wired / DC – coming soon
3041	 LINK Smart Battery – coming soon





